



FOR ORDERS AND LATEST PRODUCTS 24/7
www.apm-mouldings.com.au



AUSTRALIA



Australian Owned Family Company
Quality Moulding Manufacturers and Distributors
of Local and Imported Picture Framing Products

Contents

| | |
|--|-------------|
| ▶ ACCESSORIES | 1-33 |
| Hanging..... | 3-9 |
| Display..... | 9-11 |
| Packaging..... | 11-12 |
| Cleaning..... | 13 |
| Aerosol Cans, Tapes & Adhesives..... | 14-15 19-20 |
| Lineco..... | 17-18 |
| Spacers..... | 21 |
| Finishing..... | 21-22 |
| Aluminium Accessories..... | 23-24 |
| Hand Tools..... | 24-25 |
| Cutting..... | 26-28 |
| Nailing..... | 29-33 |
| ▶ FOAMBOARD | 50-52 |
| Barrier paper and heat press supplies..... | 53 |
| ▶ GLASS | 34-36 |
| Art Glass..... | 34-35 |
| Float Glass..... | 36 |
| ▶ MACHINERY | 54-82 |
| Cutting Machinery..... | 54-60 |
| Joining Machinery..... | 61-64 |
| Media Cutting..... | 65,67,70 |
| Mat Cutting Manual..... | 66-68 |
| Gallery Stretcher..... | 69 |
| Wizard & Zund Computerized Matcutter..... | 71-74 |
| Laminating, Glue Machines, Vacuum Press, Workstation.... | 75-82 |
| ▶ MAT BOARDS | 37-49 |
| Rising..... | 37-39 |
| Duo Board..... | 39 |
| ColourMount..... | 40-43 |
| Specialty..... | 44-46 48-49 |
| Genesis..... | 47 |

MOULDINGS

| | |
|---------------------------------|---------|
| Veneer Mouldings..... | 83-88 |
| Black Mouldings..... | 89-104 |
| White Mouldings..... | 105-112 |
| Plain Silver Mouldings..... | 113-120 |
| Plain Gold Mouldings..... | 121-128 |
| Light Stain Mouldings..... | 129-138 |
| Dark Stains and Colours..... | 139-150 |
| Ornate Mouldings..... | 151-160 |
| Slips - Fillets - Floaters..... | 161-166 |
| Synthetic Moulding..... | 167-176 |
| Aluminium & Raw Mouldings..... | 177-182 |
| Discontinued Mouldings..... | 183-202 |
| Index Moulding..... | 203-211 |
| Index Accessories..... | 212-214 |
| Pricelist..... | 215 |
| Terms & Conditions..... | 216 |

EVERY DAY ACCESSORIES

STHAW2 • Double Strap Hanger Wide

Made in USA

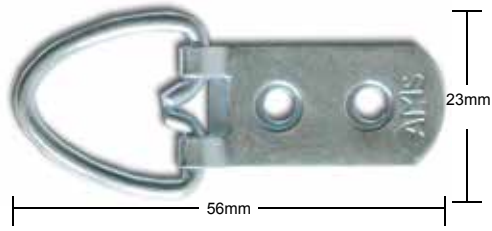

STHAN2 • Double Strap Hanger Narrow

Made in USA

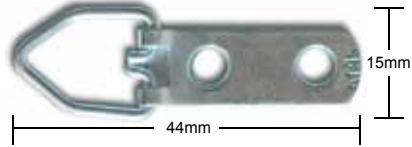

STHAW1 • Single Strap Hanger Wide

Made in USA

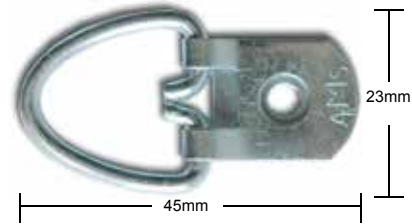

STHAN1 • Single Strap Hanger Narrow

Made in USA

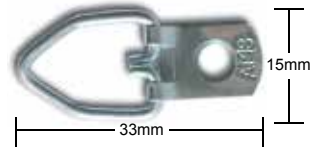

M1706 • Gauge 2 hole D Ring (Small)

Made in Italy



DRINGSML • D Ring Small Zinc plated

Made in Italy



DRINGST • D Ring Standard Zinc plated

Made in USA

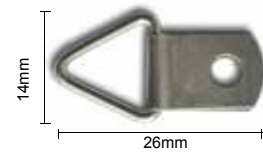

WOODH2 • 2 Hole Wood Hanger

Made in USA

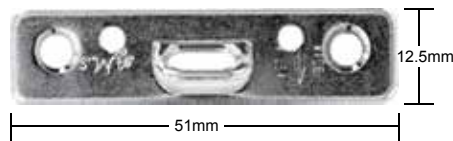

WOODH4 • 4 Hole Wood Hanger

Made in USA

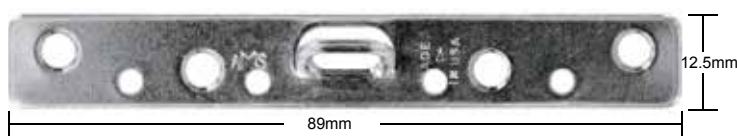

Australian made string

String/cord (Low Stretch)

High quality propylene string designed in Australia. Very low stretch properties, pure white colour.

CORD 2MM AUS 2mm Polyester string 2.0mm

500mt roll V20W500

CORD 2.5MM AUS 2.5mm Polyester string 2.5mm

500mt roll V25W500

CORD 3MM AUS 3mm Polyester string 3.0mm

500mt roll V30W500

CORD 4MM AUS 4mm Polyester string 4.0mm

500mt roll V40W40

Wire

USA MADE

code description

WIRESS 11 1 Kg Rated stainless steel

Super SoftStrand made Supersoft®

strand wire #4 259 mt

WIRESS 19 19 Kg Rated stainless steel

Super SoftStrand made Supersoft®

strand wire #5 152 mt

WIRESS 27 27 Kg Rated stainless steel

Super SoftStrand made Supersoft®

strand wire #6 89 mt

Suggested Maximum Picture Weight

11kg

19kg

27kg

Screws Self tapping

High quality self tapping screws that are made in Australia

F1200 4 Brass plated screw to suit Dring-mini Gauge x10.0mm

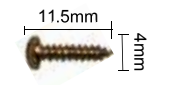

F1204 10mm 4 Gauge screw

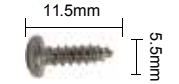

F1301 10mm 6 Gauge Screw

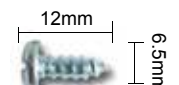

F1303 13mm 6 Gauge Screw



F1305 10mm 8 Gauge Screw



F1306 13mm 8 Gauge Screw



F1307 16mm 8 Gauge Screw

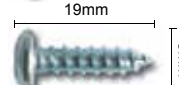

3m700clean •

3M



CRL PLASTIC

CRL



GHS GC

CRL



FLETCHER

FLETCHER FLEXIBLE POINTS TO SUIT FLEXI MASTER GUN (For use in GREEN Gun) (08-955) 3700 PER BOX

FFLP

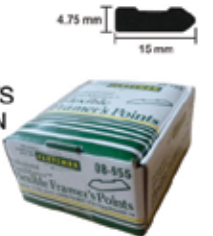

FLETCHER

FLETCHER FRAMERS POINTS TO SUIT FRAME MASTER GUN (For use in BLACK Gun) (08-950) 3000 PER BOX

FFMP



EVERY DAY ACCESSORIES

Kikusui Double Sided Tissue 190 hand applied

High performance acrylic adhesive made with Rayon paper tissue carrier for strength Excellent UV, temperature and solvent resistance also very thin and hand tearable.

Made in Japan

KIKUSUI TAPE

- Kt190ds6 ● Kikusui double sided tape handheld 6mm x 50mts
- Kt190ds12 ● Kikusui double sided tape handheld 12mm x 50mts
- Kt190ds18 ● Kikusui double sided tape handheld 18mm x 50mts



ST740DS6
(6mm)

Stylus 740 Tissue tape

stylus

ST740DS9
(9mm)

Premium grade hand applied tissue tape coated with aggressive hi-tack acrylic adhesive. Ideally suited for picture framing & photographic industries because of its ph neutral adhesive. 33m per roll
Made in JAPAN



ST740DS12
(12mm)

ST740DS18
(18mm)

ST740DS24
(24mm)

ST745DS9
(9mm)

Stylus 745 Tissue Tape

stylus

Hand applied tissue tape more economical version for when acid free is not needed.
30mt per roll, available in 2 sizes.



ST745DS12
(12mm)

Codes:

Kikusui Brown backing tapes

- Kt108b24 ● Kikusui brown backing tape 24mm x 50mts
- Kt108b36 ● Kikusui brown backing tape 36mm x 50mts
- Kt108b48 ● Kikusui brown backing tape 48mm x 50mts
- Kt108b72 ● Kikusui brown backing tape 72mm x 50mts



Kikusui White backing tapes

- Kt108w36 ● Kikusui white backing tape 36mm x 50mts
- Kt108w48 ● Kikusui white backing tape 48mm x 50mts



Codes:

Stylus Brown backing tapes

stylus

- st27072b (72mm) ● Flatback kraft paper tape sticks to itself & can be written on. Ideal picture framers tape with ph.Neutral adhesive.
- st27048b (48mm) ●
- st27036b (36mm) ●
- st27024b (24mm) ● Available in sizes: 24mm, 36mm, 48mm & 72mm



Stylus White backing tapes

stylus

- st27048w (48mm) ● Flatback kraft paper tape sticks to itself & can be written on. Ideal picture framers tape with ph.Neutral adhesive.
 - st27036w (36mm) ●
- Sizes: 36mm & 48mm



Stitchery tape

SPD1175

Stitchery Tape™

0.32 mil PET film (hand tearable) double coated with acrylic adhesive.

Stitchery tape with non-yellowing, archival adhesive system.

You longer no need to use staples, pins or glue for your tapestries.

This tape will now permanently hold down and needlework to mdf or foamboard
Made in USA



GLASSSUPER5LT

Super glass leaves glass sparkling clean available in 750ml refillable trigger spray and 5lt container



GLASSSUPER750



| CODE | DESCRIPTION | BOX QTY (Approx) |
|-----------|--|------------------|
| C1235-3 ● | Large 20mm | 2016 |
| C1235-5 | Mid Large 30mm | 2000 |
| C1235-6P | Small 19mm | 2000 |
| C1235-7 | Extra Large 40mm | 1000 |
| C1235-9 | Adjustable for 30mm & 40mm mouldings | 2000 |
| C1235-10 | Adjustable from 10mm to 40mm no folding required | 1000 |
| C1235-11 | Large 23mm | 1000 |

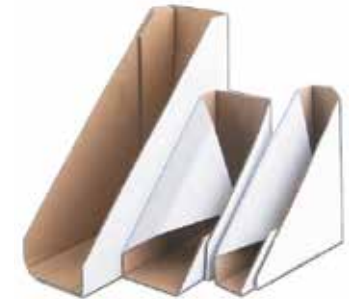

Eva Glue

Our EVA glue is of a very high quality. It contains no less than 56% solids.

EVA glue, can be rolled, brushed or sprayed on. Its ideal for mounting down, prints, posters and artwork.

Suitable for mounting onto photos, boards or paper. EVA can be removed with heat.

It has been a favorite with framers for years

| | |
|--------|----------------|
| EVA1T | EVA Glue 1lt |
| EVA 5 | EVA Glue 5lts |
| EVA 20 | EVA Glue 20lts |



PVA glue

Our PVA glue is a great wood working glue.

It is highly concentrated and has over 50% solids

| | |
|--------|----------------|
| PVA 1 | PVA Glue 1lt |
| PVA 5 | PVA Glue 5lts |
| PVA 20 | PVA Glue 20lts |

String/Cord (Low Stretch)

This string is white in appearance and is imported and is very economical in price.

| CODE | DESCRIPTION | DIA |
|--------------|---|-------|
| CORD2MM 400M | 2mm Poly Propylene cord 400mt per roll | 2.0mm |
| CORD4MM 500M | 4mm Poly Propylene cord 500mt roll R10 | 4.0mm |
| CORD5MM 500M | 5mm Poly Propylene cord 500mt roll R12 | 5.0mm |



CORD3MM500MR- 3mm Poly Propylene cord
500mt roll

CORD4MM500MR- 4mm Poly Propylene cord
500mt roll

Australian made string String/cord (Low Stretch)

High quality polyester string designed and made in Australia.
Very low stretch properties, pure white colour.

| | |
|------------------|---|
| CORD 2MM AU | 2mm Polyester string 500mt roll V20W500 |
| CORD 2MM100AUS | 2mm Polyester string 100mt roll |
| CORD 2.5MM AUS | 2.5mm Polyester string 500mt V250W500 |
| CORD 2.5MM100AUS | 2.5mm Polyester string 100mt |
| CORD 3MM AUS | 3mm Polyester string 500mt V30W500 |
| CORD 3MM100AUS | 3mm Polyester string 100mt |
| CORD 4MM AUS | 4mm Polyester string 400mt V40W40 |



Miracle Cord (Non-Stretch)

Incorporating Kevlar, the Space Age stronger than steel. User-friendly, not stiff won't twist, kink or corrode or prick your fingers. This handsome black cord is pleasant to handle, easy to attach and extra ordinarily strong and secure.

| | |
|--------------|---|
| MIRACLEREG | It does not stretch Picture weight 18kg 305m long 1.6mm |
| MIRACLEHEAVY | Picture weight 35 kg 183cm long 1.8mm |



Zenith

| code | max weight | metre per roll |
|--------|------------|----------------|
| WIRE#3 | 9.1kg | 335 |
| WIRE#4 | 11.3kg | 255 |
| WIRE#5 | 19.5kg | 150 |
| WIRE#6 | 27.2kg | 83.8 |

Wire

| code | description | Weight | Suggested Maximum Picture |
|-----------|---|--------|---------------------------|
| WIRESS11 | 11 Kg Rated stainless steel USA made Supersoft® strand wire #4 259 mt | 11kg | |
| WIRESS19 | 19 Kg Rated stainless steel USA made Supersoft® strand wire #5 152 mt | 19kg | |
| WIRESS27 | 27 Kg Rated stainless steel USA made Supersoft® strand wire #6 89 mt | 27kg | |
| WIRESS45 | 45 Kg Rated stainless steel strand wire #8 38 mt | | |
| WIREBR2 | Braided galvanized steel picture weight (6.8kg) 457m per roll | | |
| WIREBR4 | Braided galvanized steel wire 24lbs (11.0kg)W14A 259 mt | 11kg | |
| WIREBR6 | Braided galvanized steel wire 35bs (16.0kg) W16A 191 mt | 16kg | |
| WIREBR8 | Braided galvanized steel wire 45lbs (20.5kg) W18A 152 mt | 20kg | |
| WIRELON11 | 11kg clear plastic coated steel wire 11kg 255mtrs | | |
| WIRELON19 | 19kg clear plastic coated steel wire 19kg 152mtrs | | |

Mirror Chain

Steel mirror chain, nickel plated - for when you need that added hanger strength. This quality steel mirror chain is very strong and has a maximum weight of 30kgs. It is finished in zinc and has 20mts on a roll.

It will certainly add value to your mirrors or larger frames.
MIRRORCHAIN Mirror chain zinc coated 20mts a roll



Surflon Wire

Surflon®

| | | |
|-----------|--|------|
| WIRESUF14 | 14kg Surflon Wire, cord stainless steel wire to be used with crimps 333mt #2 | 14kg |
| WIRESUF18 | 18kg Surflon Wire, cord stainless steel wire to be used with crimps 333mt #3 | 18kg |
| WIRESUF27 | 27kg Surflon Wire, cord stainless steel wire to be used with crimps 333mt #4 | 27kg |
| WIRESUF48 | 48kg Surflon Wire, cord stainless steel wire to be used with crimps 333mt #7 | 48kg |



Suflon Wire System Instructions

Step #1: Feed Surflon Wire through the properly sized sleeve and hardware.

Step #2: Pass the wire back through the sleeve.

Step #3: The standard procedure is to pass the wire through the sleeve twice, but you can slip the wire through a third time if you prefer.

Step #4: Next, firmly crimp the sleeve and wire together using our special crimping pliers. We recommend making two side-by-side crimps on each sleeve.

Step #5: The sleeve and crimp are now secure. To finish the job, repeat this procedure on the opposite side of the frame.

Crimping Sleeves for Suflon Wire

Nickel-Plated Crimping Sleeves are slipped over Surflon wire and then secured with Crimping Pliers to fasten wire quickly to change D RINGS.

| Code | Use with wire | Sleeves / Bag |
|-------|---------------|---------------|
| 06S1M | WIRESUF14 #2 | 1000 / bag |
| | WIRESUF18 #3 | 1000 / bag |
| 06M1M | WIRESUF27 #4 | 1000 / bag |
| 06L1M | WIRESUF48 #7 | 1000 / bag |



PLIERSCRIMP

Crimping Pliers for Suflon Wire 8-1/2" Deluxe Crimping Pliers are used to fasten Crimping over Suflon Wire.



CRIMPING GUN

Wire Crimp Tool is an air-driven tool that automatically remove feeds rings to crimp together picture framing wire quickly and safely. It saves wire because no twisting of ends is required. A 10-foot polyurethane (coiled) hose is included with crimp gun purchase

WR-1

Wire crimp for crimping gun. 13,000 in a box



WIRECADDY

The new Wire Caddy Support makes spools of Wire easily dispensable and portable.

Bumpers

Bumpers are great to use on the back of your frame as they protect your wall from damage from the frame rubbing against it. Diameter is 15mm x 3mm thick. They also allow air to circulate and prevent build up of mould. It also adds a more finished look to your custom framing.

BUMPFELTBK

Husky brand Black felt bumpers

1000 dots per roll 15mm Diameter 3mm thick



BUMPFELTWH

Husky brand White felt bumpers

1000 dots per roll 15mm Diameter 3mm thick



BUMPFEOAMBK

Husky brand Foam bumpers

1200 dots per roll 15mm Diameter 3mm thick



WOODH2

2 Hole Wood Hanger

Made in USA

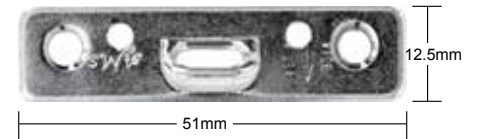

WOODH4

4 Hole Wood Hanger

Made in USA

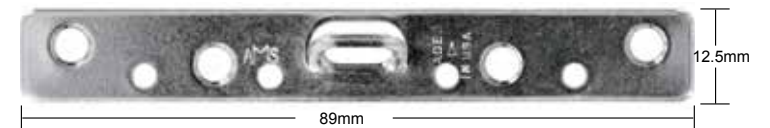

STHAW1

Single Strap Hanger Wide

Made in USA

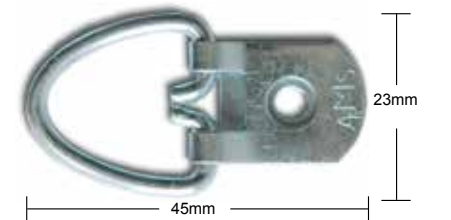

STHAN1

Single Strap Hanger Narrow

Made in USA



STHAW2 
Made in USA

Double Strap Hanger Wide

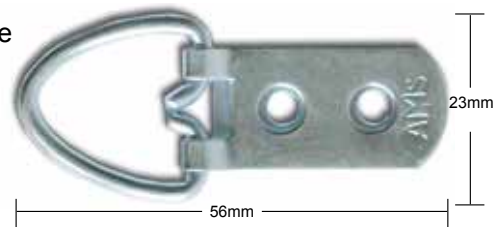

STHAN2 
Made in USA

Double Strap Hanger Narrow

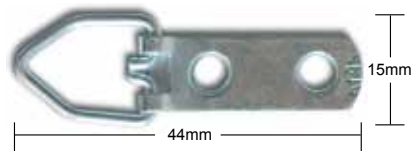

STHAW3
Made in USA

Triple Strap Hanger Wide

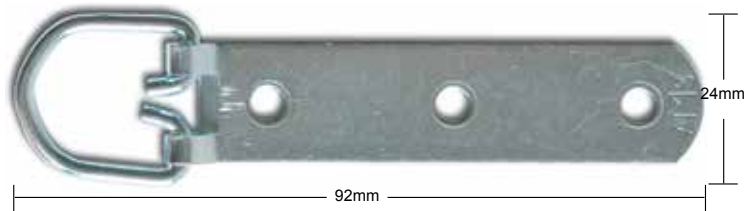

STHAN4
Made in USA

4 hole narrow hanger



PTA3-1H
Made in USA

Adhesive hanger, Clear PVC Sawtooth hanger to hang up to 1kg(bags of 100) size 55x 48mm

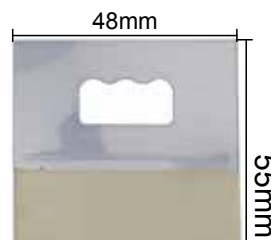

ADJUST HANG
Made in USA

Precise Height Adjustable Hanger

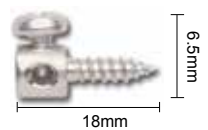

TB15
Made in USA

15MM TURN BUTTONS



DRINGMINI
Made in USA

Mini Brass plated DRING for use with screw F1200

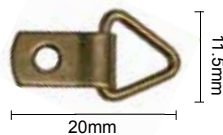

DRINGSML 
Made in Italy

D Ring Small Zinc plated



DRINGST 
Made in USA

D Ring Standard Zinc plated



DRINGEXSM
Made in Italy

D Ring Extra Small



M1706 
Made in Italy

Gauge 2 hole D Ring(Small)



RH4-1MK
Made in Italy

Heavy gauge 2 hole D Ring (Large)



SAWTOOTH48
Made in USA

48mm Sawtooth Hanger (Small)



SAWTOOTH76
Made in USA

76mm Sawtooth Hanger (Large)



MP1

MP1 Small Mending plates with 2 holes designed to accept #4 x " flat head phillips screws

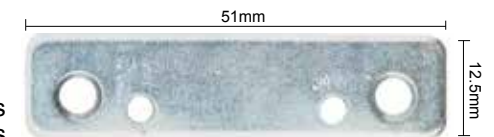

885C-300

885C-300 Extra Large Re-enforcing corner braces are used to strengthen corner joins of picture frames and stretcher bars.

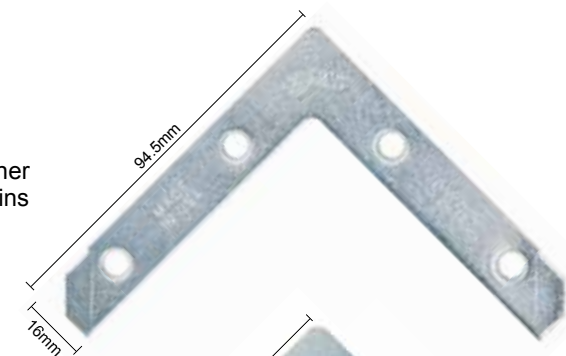

MP4C-1H

MP4C-1H Large Re-Enforcing are used to strengthen corner joins of picture frames and stretcher bars zinc clear plated

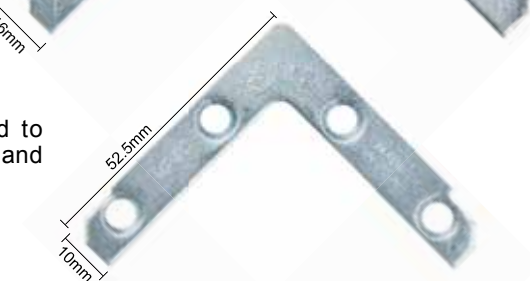

MP2

MP2 Large Mending Plates with 4 holes designed to accept our #4 x " flathead phillips screws. Holes are staggered in alignment in order to reduce the chance of splitting wood.

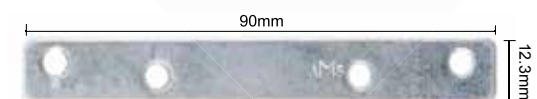

Foamboard hanger + MDF Hanger

These Foamboard Hangers can be installed on foam board of various thicknesses, but nothing less than 5mm.

Do not use on boards less than 3/16" (4.8mm) thick to prevent damage to artwork. Plated zinc clear.

FBHANGER Foam board hanger
Made in USA

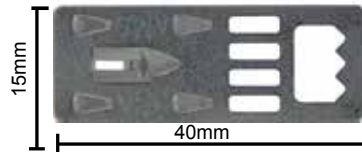

KH2B Kwik hanger for attachment to MDF board
Made in USA

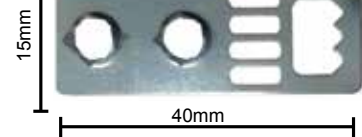

KH-BLOCK Magnetic holder for KH-2 and KH-3 kwik hangers
Made in USA



Security Accessories

Minimum order QTY 100 except for the complete sets
The below security all works together and offers the most protection as a theft deterrent.

SS-MBA Security Mount Brackets For Aluminum
Made in USA

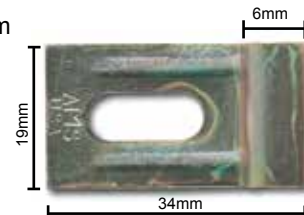

SS-TSC Security Screws
Made in USA



SS-PLA Security Plate
Made in USA



SS-WRE Security Wrench
Made in USA

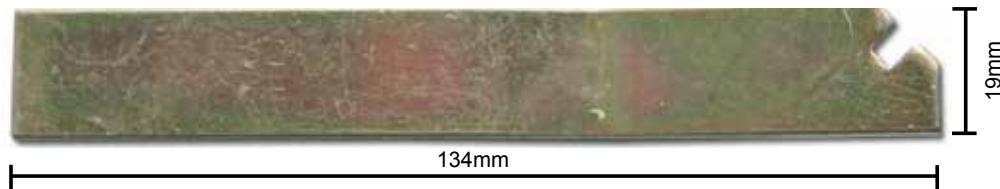

SS-ANCOR Plastic Bullet Shaped Wall Anchor For SS-TSC
Made in USA



SS DRILL BIT For T-screw with 1/4 inch Hex head
Made in USA

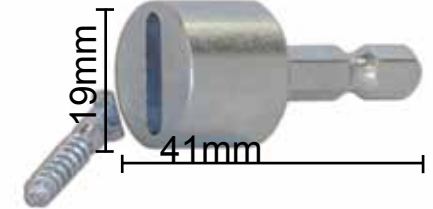

This is a stand alone system that requires 2 security plates per frame in the place of wire or code.

To fix to the wall all that is required is 2 self tapping screws and then nudge the picture left or right.

SS-NEW New Security Plate

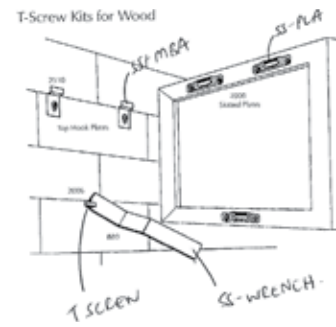

SS-SET Consists of
SS-MBA x 2
SS-PLA x 3
SS-TSC x 1

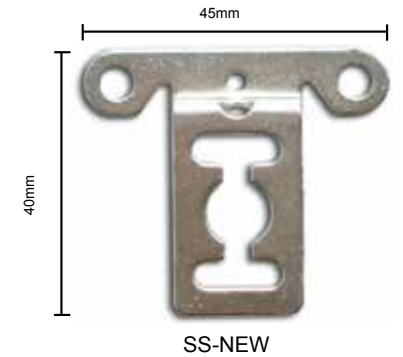

Spring Security Hanging System



SpringLOCK Method 1 (Side to side) **SpringLOCK Method 2 (Hanging Plate)**

The SpringLOCK is a two part component consisting of a Bridge and a Locking Spring Insert. Instead of using more SpringLOCKS on any frame, the Top Slot Brackets can be substituted.



JT612
Made in USA

Offset Dring Hanger

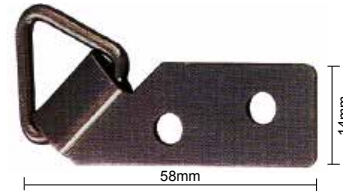

186-6D-1
Made in USA

One piece ring hanger(FLAT)



186-6D-2
Made in USA

One piece ring hanger(BENT)



PICTURE RAIL HOOKS BRASS moulding hooks

Made in USA



PICTURE PLATE Brass plated picture plate

Made in USA

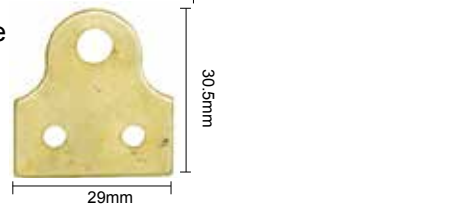

Hand held poncher

The puncher is pushed into wooden mouldings to create a pilot hole ready to accept installation of screw or screw eye. The tip is hardened to be strong enough to push holes into hardwood as well as softwood. No mess of wood chips is created.

PUNCHER Made in USA



Ezybar Made in USA

Designed to handle large and heavy frames

Made from extruded aluminium and have pre drilled holes every 100mm to make it easy to mount on the wall and find studs. All lengths are 1.8mts long. Available in 3 sizes

BARZB1-72 1.8mt hanging bar small upto 16kgs
1.02mm thickness



BARZB2-72 1.8mt hanging bar medium upto 36kgs
1.25mm thickness



BARZB3-72 1.8mt hanging bar large more than 36kgs
2.03mm thickness



TWIRLER

The easiest way to insert screw eyes in a frame is in four easy steps

1. Make pilot hole with Twirler
2. Put screw eye in pilot
3. Put twirler in screw eye and turn
4. Twirl until tight



SCRATCHAWL

Use for starting holes for screws and nails

Screws Self tapping

High quality self tapping screws

F1200 Brass plated screw to suit Dring-mini
4 Gauge x10.0mm. Panhead.



F1204 10mm 4 Gauge screw. Panhead.

F1301 10mm 6 Gauge Screw. Panhead.

F1303 13mm 6 Gauge Screw. Panhead.

F1304 16mm 6 Gauge Screw. 5/8 Panhead.

F1305 10mm 8 Gauge Screw. Panhead.

F1306 13mm 8 Gauge Screw. Panhead.

F1307 16mm 8 Gauge Screw. Panhead.

F1431 1 1/2" 6 Gauge Screw.
Counter sunk head

F1517 13mm 8 Gauge Screw. 1/2 counter sunk head

F1424 8 Gauge 32mm counter sunk

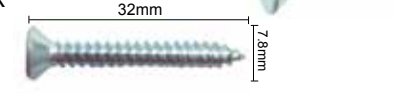
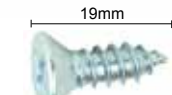
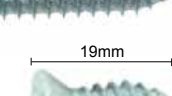
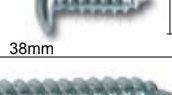
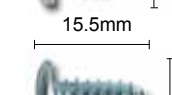
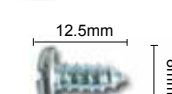
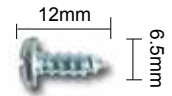
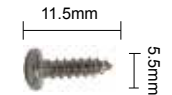

Screw Eyes

A traditional way of applying wire to the back of frames. These screws are zinc plated
Made in USA

SE17 SE20 SE25

Made in USA Made in USA

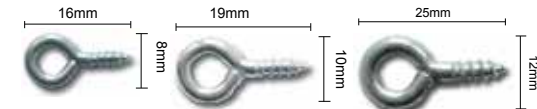

Brackets & Hooks

Minimum order QTY 100

These brackets are great for attaching a box frame to a picture frame moulding, especially useful when object framing.

LBRAC15 Small corner bracket

LBRAC23 Large corner bracket

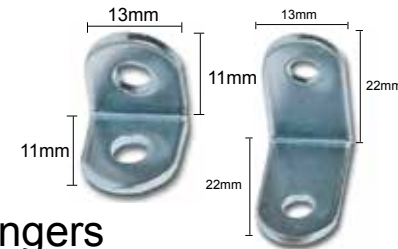

CWH- square sawtooth hangers

CWH1

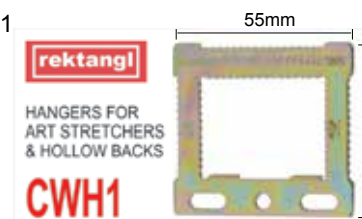

CWH2

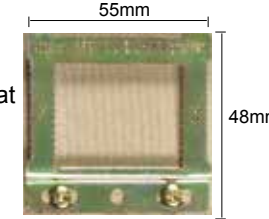

For frames with flat or papered backs

Gallery Hanging System

The Gallery System is a strong flexible picture hanging system which can be adapted quickly to your changing needs of any gallery.

Track fixes to the wall. Available in either white or anodized silver finish. Hangers fit into the track and adjust side to side. Hooks fit onto the hangers and adjust up and down.

Two choices of hangers are available either clear plastic or stainless steel cable.

THE GALLERY SYSTEM TRACK
2 METRES
ANODIZED SILVER

GTRACK2

THE GALLERY SYSTEM TRACK
2 METRES
WHITE

GTRACK2W

THE GALLERY SYSTEM TRACK
3 METRES
ANODIZED SILVER

GTRACK3

THE GALLERY SYSTEM TRACK
3 METRES
WHITE

GTRACK3W

30 METRE CLEAR TAPE &
10 LOCKING CAPSULES
PER PACK

GBLHANPCT

PICTURE RAIL HANGERS
5 x 2 METRE STAINLESS
STEEL CABLES & 5 STAINLESS
STEEL PICTURE RAIL HOOKS
PER PACK

GBLPRHANG5S

ADJUSTABLE PUSH
BUTTON HOOK
SUITS STAINLESS STEEL
CABLE & PICTURE RAIL
HANGER 10 PER PACK

GBLPBHOOP

END CAPS FOR TRACK
WHITE

GENDCW

10 x 2 METRE STAINLESS
STEEL CABLES & 10
TRACK SLIDES PER PACK

GBLHANPSSC

10 x 1.5 METRE STAINLESS
STEEL CABLES & 10
TRACK SLIDES PER PACK

GBLHANPSSC1.5

10 x 3 METRE STAINLESS
STEEL CABLES & 10
TRACK SLIDES PER PACK

GBLHANPSSC3

10 x 1 METRE STAINLESS
STEEL CABLES & 10
TRACK SLIDES PER PACK

GBLHANPSSC1

PICTURE RAIL HANGERS
5 x 2 METRE STAINLESS
STEEL CABLES & 5 BRASS
PICTURE RAIL HOOKS
PER PACK

GBLPRHANG5

ADJUSTABLE HOOK
SUITS CLEAR TAPE,
STAINLESS STEEL
CABLE & PICTURE RAIL
HANGER 10 PER PACK

GBLHOOP

ADJUSTABLE SECURITY
PUSH BUTTON HOOK TO
AVOID THEFT SUITS STEEL
CABLE & PICTURE RAIL
HANGER 10 PER PACK

GBLSECPB

END CAPS FOR TRACK
ANODIZED SILVER

GENDC

Slimline
art hanging system

GSL.TRACK2W SLIMLINE TRACK 2 METRES WHITE

GSL.TRACK2 SLIMLINE TRACK 2 METRES ANODIZED SILVER

GSL.HANPSSC STAINLESS STEEL CABLE HANGERS 10 x 2 METRE STAINLESS STEEL TAPE HANGERS PER PACK

GSL.ENDCP2W END CAPS FOR SLIMLINE TRACK WHITE 2 PER PACK

GSL.WALLP SLIMLINE WALL ANCHORS 5 PER PACK

GSL.HANPCT CLEAR TAPE HANGERS 10 x 2 METRE CLEAR TAPE HANGERS PER PACK

GSL.ENDCP2 END CAPS FOR SLIMLINE TRACK ANODIZED SILVER 2 PER PACK

GSL.HOOP SLIMLINE MINI HOOK SUITS CLEAR TAPE OR STAINLESS STEEL HANGERS 10 PER PACK

GSL.PBHOOP SLIMLINE PUSH BUTTON HOOK SUITS STAINLESS STEEL CABLE SYSTEM 10 PER PACK

Now you can hang your art the way galleries do.

This new system is designed for home and office use. It's very unobtrusive system based on a very slim track which is designed to butt up against your ceiling or cornice where its barely visible.

How does it work?

The track is fitted to the wall using our nylon 'wall anchors', you butt them up against ceiling and crew them in place. The track then spans onto the wall anchors. Next you fit the hangers into the track and then fit the hooks onto the hangers. There's a choice of clear Tape or Stainless Cable Hangers and a choice of hooks. Gallery Systems have been designing and making hanging systems in Australia for twenty years and exporting to countries around the world.

The Gallery Lighting System

Low voltage light wands lock onto the same track that hangs your art. The light wands simply lock onto the track at any point and light up

GL2.TR105 The Gallery System 105 VA TRANSFORMER KIT SUFFICIENT TO SUPPLY UP TO 8 WANDS OVER A 3 METRE CABLE

GL2.WAND The Gallery System LIGHT WAND

GL2.TR300KIT The Gallery System 310 VA TRANSFORMER KIT SUFFICIENT TO SUPPLY UP TO 12 WANDS OVER A 15 METRE CABLE

- GL2.CABLE BLUE POWER CABLE
- GL.CNRSTW STRAIGHT COVER WHITE
- GL2.CNRST STRAIGHT COVER ANODISED
- GL2.CNRIN INSIDE CORNER COVER
- GL2.CNRINW INSIDE CORNER COVER - WHITE
- GL2.CNROUT OUTSIDE CORNER COVER ANODISED
- GL2.CNROUTW OUTSIDE CORNER COVER WHITE
- GL2.DSTAPE DOUBLE SIDED ADHESIVE TAPE
- GL2.LAMP LAMPS-GE CONSTANT COLOUR
- GL2.JBOX JUNCTION BOX
- GL2.TOR300VA 300VA TOROIDAL TRANSFORMER
- GL2.TR200KIT TRANSFORMER KIT 200 VA



Picture Wall Hooks

These brass picture hooks are a great way to hang picture to your walls.

B1010 (Including Nails) Picture hook (4.5KG) Hanger and 1 Nail
19mm Long nail

B2040 (Including Nails) Picture hook (11KG) Hanger and 2 Nails
25mm Long nail

Mirror Hook

Flush mounts consists of two parts. The first part is putting two flush mounts on the back of the framer where otherwise the string would go. These must have the flat side towards the top of the side facing the ground. These are designed for heavy frames and mirrors.

FM-2 New mirror hook 4 per frame
made in USA

MIRRORCLIPLRG

Mirror clip to hang mirror without frames
(directly on wall 35mm x35mm.)
Mirror thickness 6mm

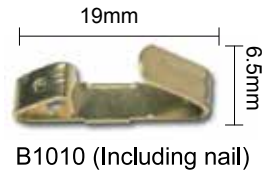
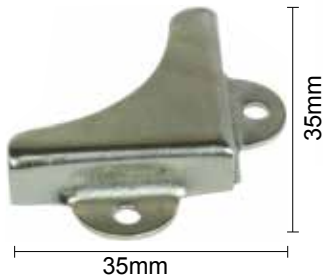

Acrylic display boxes

Made from high quality clear perspex to house your sporting memorabilia. They also have a black base to help the ball stay in place they are available in 3 sizes

Soccer Boxes display box for soccer and basketball.
Internal size: 250mm x 250mm x 242mm
3mm thick perspex

Cricket ball case display box for cricket, baseball and tennis.
Internal size: 95mm x 95mm x 81mm
3mm thick perspex

Football boxes display box for NRL AFL and union.
Internal size: 325mm x 190mm x 167mm
3mm thick perspex



Standoffs

Stand offs for acrylic mounting



Moulded Sports Acrylic

It's often hard to frame sporting objects. We have the solution. Moulded acrylic forms for Soccer, Football, Boxing, Tennis and Golf. You merely order the form and tell us how big you want the Perspex sheet and where you want the cut out, its that easy. Make your sporting objects look professional.



Football Display CASTFOOTBALL

Soccer Ball Display CASTFOOTBALL



Gloves Display CASTBOXING



CRICKET Ball Display
CASTCRICKET



Golf Ball Display
CASTGOLF

Sample Board Front Runner

1300mm black display front runner 380gms
Sold per Lineal metre

CARPET BLACK



Print V Bins & Sleeves



Made in AUSTRALIA



Features

These quality constructed V Bins constructed in Australia will make any show room look modern & Stylish, with their sleek chrome finish.

The V Bin mounted on 4 castor rollers with locks is designed to display prints 30x40" or 76.2x101cm. It can hold up to 25 sleeves at once. Custom sizes for the V Bins are available upon request.

Quality display sleeves with black edging, metal corners and ultra clear plastic would compliment any prints.

Available in:
v BIN 30 x 40"
v BIN 40 x 60"

Poster sleeves
DELP530 30 x 40"
DELPS40 40 x 60"

Photoframe Easel & Hinges

Easel hinges make it possible to make stand backs to use in photo frames
The stand back clip also allows you to hang your photo frame.

HINGES Small Craft Brand Small Easel Hinge 28mm wide

Made in USA



HINGES LARGE Large Easel Hinge 38mm wide

Made in USA



AM HINGE AMS brand New Style Hinge

Made in USA

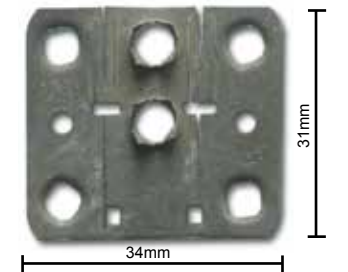

SB CLIP SML Craft brand Stand Back Clip Small

Made in USA

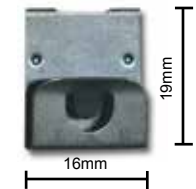

SB CLIP NEW Stand Back Clip New

Made in USA



Swiss Clips

Swiss Clips that are made with the highest degree of accuracy. Original high quality

SWISSCLIPS SML Small swiss clips

MADE IN EUROPE

SWISSCLIPS LRG Large swiss clips

MADE IN EUROPE

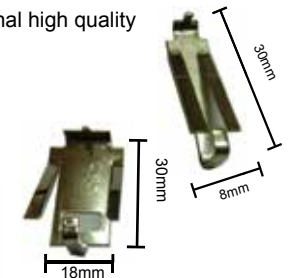

Easel

EASELPEWTER150

The ideal decorative easel for your showroom and gallery display. Bronze colour 150cm



Stand Backs

High quality natural MDF stand backs made here in Australia.
The over hand from the leg is standard 10mm long

| Code | Size |
|--------|----------------------------|
| SB355 | 3.5 x 5 inch |
| SB46 | 4 x 6 inch |
| SB57 | 5 x 7 inch (127 x 178mm) |
| SB68 | 6 x 8 inch (152 x 203mm) |
| SB79 | 7 x 9 inch (178 x 229mm) |
| SB810 | 8 x 10 inch (203 x 254mm) |
| SB812 | 8 x 12 inch (203 x 304mm) |
| SB1114 | 11 x 14 inch (279 x 356mm) |
| SB1012 | 10 x 12 inch (254 x 304mm) |
| SBA4 | A4 210 x 297mm |



Curl up & Stand

- A. KS2 BLACK Black slide on hanger for curl up & stand (3mm)
- B. LS01 BLACK Short black curl up n'stand leg
- C. LL01 BLACK Long black curl up n'stand
- D. KS2 BRASS Brass slide on hanger for curl
- E. LS01 BRASS Short brass curl up n'stand leg
- F. LL01 BRASS Long brass curl up n'stand leg

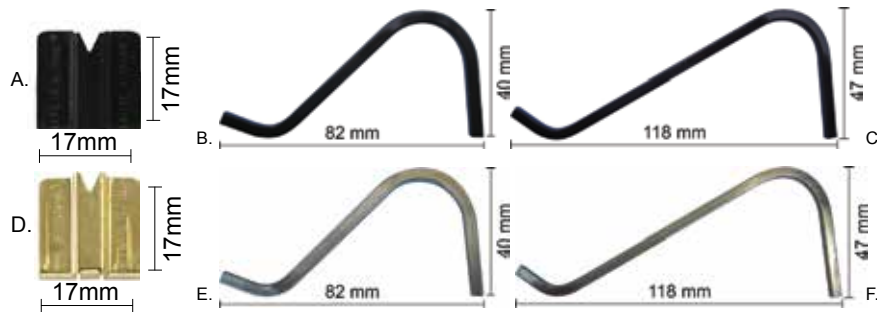

- KS11-L BR Kiasu Easel Large brass
- KS11-S BR Kiasu easel small brass



Velcro Dots

- MT15 Velcro brand 15mm hook dots (100dots)
- MT22 Velcro brand 22mm hook dots (100dots)



Stainless steel pins

PINSTAINLESS



MARK III FASTENING PISTOL
USES AVERY 10070
FINE FABRIC STEEL NEEDLES

AVERY 10312



Avery Fabric Tools



FINE FABRIC STEEL NEEDLES
FOR AVERY 10312
MARK III FASTENING PISTOL
4 PER PACK
AVERY 10070



11 mm NYLON T-END FASTENERS
FOR AVERY 10312
MARK III FASTENING PISTOL
50 PER CLIP - 5,000 PER PACK
AVERY 10689



7 mm NYLON T-END FASTENERS
FOR AVERY 10312
MARK III FASTENING PISTOL
50 PER CLIP - 5,000 PER PACK
AVERY 10446

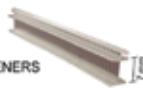

PACKAGING

Kraft Paper and Kraft Dispenser

Kraft paper allows you to cover the back of your frames to look great and stop dust.

Kraft paper is also handy to wrap your frames to protect them during transport.

| CODE | DESCRIPTION | ROLL MTRS |
|----------|----------------------------------|-----------|
| KPR60060 | Brown Kraft Paper, 600mm x 60gsm | 340 mts |
| KPR60085 | Brown Kraft Paper, 600mm x 85gsm | 270 mts |
| KPR910 | Brown Kraft Paper, 900mm x 60gsm | 500 mts |

| | | |
|-----------|-----------------------------------|---------|
| KPRB91220 | Black paper, 1220mm x 85gsm | 229 mts |
| KPR9B910 | Black paper, 915mm x 85gsm | 220 mts |
| KPR1220 | Brown Kraft Paper, 1220mm x 85gsm | 270 mts |

DIS910 Brown Kraft Paper Roll Dispenser 910mm wide

DIS1000 Brown All in one cutter can use on paper & cellophane roll Dispenser for table packaging

DIS1220 Brown Kraft Paper Roll Dispenser 1200mm wide

DIS910V Brown Kraft Paper Roll Dispenser Verticle 910mm wide

DIS1220V Brown Kraft Paper Roll Dispenser Verticle 1200mm wide



Hassle Free Trimmer

Saves you time, money and improves the finished look of your product. Trimmer has a comfortable grip. Works equally as well for right and left hand users.

HASSLETRIM



Packaging tape

Opp clear packaging tape for use on paper, cardboard or foamboard.

PACKTAPE48 Clear packing tape 48mm x 75mt rolls



PACKTAPE36 Clear packing tape 36mm x 78mt rolls

TAPEFRAGILE48



TAPE ST620



Nachi ideal office tape.
Clear in colour
and economical in price.



Plastic Wrap - Made in Australia

This bundling film helps protect your frames from damage

PLASTICW Cardboard core hand held plastic wrap
100mm x 300mts



PLASTIC BUNDLER Ultimate stretch Free handle with every box
100mm x 250m



PLASTICWRAP Red core no handle Plastic Wrap
125mm x 300mts



Paper corrugated corners

Attractive white finish on these corrugated cardboard corners. Corners are supplied in die cut sheets ready to break apart.

They can be used on timber, synthetic or aluminium frames. Corners lock in place on most frames so they don't fall off.

Corners are then folded together. They come in a variety of sizes.

| CODE | DESCRIPTION | BOX QTY (Approx) |
|----------|--|------------------|
| C1235-3 | Large 20mm | 2016 |
| C1235-5 | Mid Large 30mm | 2000 |
| C1235-6P | Small 19mm | 2000 |
| C1235-7 | Extra Large 40mm | 1000 |
| C1235-9 | Adjustable for 30mm & 40mm mouldings | 2000 |
| C1235-10 | Adjustable from 10mm to 40mm no folding required | 1000 |
| C1235-11 | Large 23mm | 1000 |
| C1235-12 | 62mm | 1000 |



Cellophane

Ideal for wrapping picture frames & canvas

CELLOPHANE1 Roll 1m x400m



PALLET WRAP

PALLET WRAP 500mmx400mts x23um



Bubble Wrap Roll

BUBBLEWRAP250

Bubble Wrap 275mmx100mt
Double sided bubble wrap



BUBBLE WRAP ROLL

Bubble Wrap 1.5mts x100mt(20mm bubble)
Double sided wrap



Mattboard Boxes

Empty matboards for packaging matboards

BOX MAT32X40 32" x 40" 810mm x 1016mm
BOX MAT40X60 40" x 60" 810mm x 1524mm

CYLINDER cylinder for packaging rising matboard 450x4x1600mm



Tyvek

Tyvek has been used by museums for years because it is virtually puncture proof and provides moisture resistance. The clean white look sets your work apart from ordinary jobs and emphasises the archival nature of your framing. Great for wrapping frames or as a dust cover.

| code | description |
|----------|-------------------------|
| TYVEK915 | 915mm wide x 64mts long |



Matboard Storage Cart

ULTIMO Storage cart for matboards
capacity of cart is 160x32x40 sheets of matboard.



CLEANING

3m Scotch brite high

Performance cleaning cloth size is 320mm x 300. These cloths are great for cleaning glass and in fact can polish most surfaces. They are designed in a way that absorbs grime even without using harsh chemicals. They also leave a streak free and lint free surface, the cloth can be washed and reused many times.

3HICLOTH



Kimberly clark work horse rags wypall

The premium clean wipe to help you with your cleaning jobs, leaving your glass very clean. Colour: white. Dimensions: 32x5cm x 42cm. Quantity per pack: 150 wipers. HYDROKNIT material. Durable, high performance, and fast absorbing material. Perfect for heavy duty jobs.

WYPALL



Hydrowipes

A soft, absorbent and low lint blue coloured cloth. Great for cleaning glass size 380x400mm 100 sheets per box Constructed by a unique hydro-entangling process which uses thousands of high pressure, needle-like jets of water to entangle the fibres into a Sontara fabric made by Dupont. Fully recyclable Cut and Packed in Australia



Tiger Cloth

The tiger cloth is an anti-static, microfibre cloth that has been specifically engineered for cleaning photographic films. The orange cloth has stripes of effective conductive fibres knit every 4mm that dissipate or drain off static charges. The tiger cloth is not wet or "soggy" and exposure to air won't dry it out. The ultra soft cloth is so gentle you'll feel comfortable using it on acrylic. Hundreds of thousands of small pockets in the microfibre cloth aggressively capture the dust and dirt from the Perspex The tiger cloth comes packaged in a zip lock bag.

TIGERCLOTH Size: 250mm x 450mm



Rub Gum Cleaning Pad

Rub gum cleaning pad for cleaning mat boards and linen slips, document cleaning pads contain a super soft grit free powder and are recommended for cleaning dirty or mouldy paper items. Lightly twist pad to release it's powder, then gently rub over the soiled area to absorb both dirt and dust. Long lasting and easy to use.

PADCLEANING



Static Wisk

The kinetronics ANTI STATIC wisk is used for cleaning lenses, films, scanners, cameras, plastics and acrylics. The unique blend of soft natural hair and conductive synthetic fibers plus the conductive nature of construction result in effective static dissipation. Dust and lint are whisked away.

STATIC BRUSH Small antistatic brush
STATIC BRUSH L Large antistatic brush



STATIC GUN

significantly boosts the cleaning power of compressor air by creating a flow of ions that neutralize static charges and release clinging dust



Artglass cloth

art glass has produced a strong and soft microfibre cloth to meet the most discerning framer. Size is 40cm x 40cm Ideal for all types of glass especially for art glass and truvue
CODE :AGCLOTH



Art glass cleaner

Your perfect choice for any type of glass !Amonia free, Leaves no residue, Static free, Non-streaking, 500ml
AGGLASSCLEANER



Antistatic Gloves

The ANTISTATIC gloves, a remarkable blend of soft conductive and synthetic fibers. The conductive gloves suppress the dust collecting electrostatic charges when handling delicate and sensitive static prone materials. Use gloves when handling films, plastics, optics and glass to prevent fingertips and scratching. When soiled the gloves may be washed with a gentle soap or detergent and tumble-dried at the 'warm' setting.
GLOVES ANTISTAT Antistatic Gloves



Cotton Gloves

These cotton gloves will have plenty of uses around the workshop, ideal for handling delicate items like mat boards and fine art and you will think how did I ever do it without them.
Available in 2 sizes: GLOVES COT SML white cotton small gloves
GLOVES COTTON white cotton large gloves

Apron

High quality apron. Designed with heavy duty twill material. Has two pockets and is burgundy in colour and has the aprm logo on there. It is very comfortable and can be adjusted for small to large frame beds. It conveys a professional look that will please your customers.



Glass Gripper Gloves

A cheap and simple way to protect your hands when handling glass. These long lasting rubber gripper gloves are essential for the busy framer.
GLASSGLOVES



Novus Plastic Scratch Remover Made in the USA

Plastic Scratch Remover 210 plus will remove all but the deepest surface scratches. Restores a brilliant finish to formerly dull surfaces. Anti-static and anti-fog. 440ml used by the Metropolitan Museum of Fine Art. Kennedy Library & National Gallery of Art.
NOVUS Plastic Scratch remover 210 plus



Kneaded rubber

It's excellent for removing or highlighting pencil, chalk and pastel This popular eraser kneads easily into shape, erases cleanly and picks up all residue.
RUBBERKNEADED Eraser



NOVUS #1 plastic clean & shine 236ml

NOVUS #2 fine plastic scratch remover 236ml

NOVUS #3 heavy scratch remover



Kunststoff Acrylic Cleaner

500ml acrylic, anti static cleaner. An industry standard Made in Germany
KUNSTSTOFF500



Aerosol Cans, tapes & adhesives

- NAM 5515030010 **Crystal Clear**
Colourless glossy protection for art. Also waterproofs and prevents the tarnishing of metals. 400g can
- NAM 5515030030 **Matt Spray**
Permanent protection for photographs, prints, artwork and most transfer lettering. Helps protect from U.V and reduces glare on glossy surfaces. 400g can
- NAM 5515030040 **Picture Varnish Gloss**
Colourless varnish for oil and acrylic paintings with a high gloss finish. 400g can.
- NAM 5515030050 **Picture Varnish Matt**
Colourless varnish for oil and acrylic paintings with a non-reflective finish. 400g can.
- NAM 5515030060 **Retouch Varnish**
Semi-permanent colourless protection for oil and acrylic paintings. Can be reworked later. 400g can.
- NAM 1115030350 **Spray Adhesive**
For paper, card, fabric and photos. Temporary or permanent tack. 350G can.
- NAM 5515030070 **Workable Fixative**
Protection for drawings or pastels to reduce smudging. Art may be reworked later. 400g can.
- 3m700clean **3M 700 Adhesive Cleaner and Solvent**
It contains no petroleum distillates. 3M Citrus Base Cleaner can be used to clean and degrease metal parts, motors, tools, printing presses, concrete, or almost any dirty or greasy surface. 350grams



3MPHOTOSPR

3M 73 Photo & Print Mount Adhesive ear adhesive for mounting of black &.white and colour photographs, prints,illustrations, maps and lightweight paper objects. Will not yellow or wrinkle.Not acid free. Can size 292grams.

3M75REPOSITION

3M 75 Repositionable Adhesive This adhesive provides tape-like bonds on many lightweight materials. It adheres in seconds, yet has an extra-long tack range that allows you to lift and reposition materials. 290grams

3MSUPER77

3M Super 77 Multipurpose Adhesive 3M Super 77 Multipurpose Adhesive is an extremely versatile, fast-drying adhesive that bonds a wide range of lightweight materials. Its fast, aggressive track and low soaking make it ideal for projects all around your home or business. It forms strong bonds with everything from paper, cardboard, fabric and cushion foam plastic, metal, wood and much more. 467grams.

3MGLASS500

3M Glass cleanerAerosol Can Considered by most as the best glass cleaner on the market. As with most items 3M products offer the highest.

GHS GC

CRL Glass cleaner Industrial strength glass cleaner made by CRL. It's low pleasant odour and is ammonia free. Leaves a nice polished and shiny surface.

CRL PLASTIC

CRL Aerosol Plastic Cleaner is an antistatic. anti-fog,non-streaking formula that is fast drying and economical to use. Apply to a variety of plastic materials such as Acrylic:Plexiglas, polycarbonate, and safety glazing panels. CRL plastic cleaner wipes away without streaking, and leaves a sparkling clean surface. Large can of 539 grams which goes a long way.

TRUVUE5LT

Tru Vue glass cleaner ammonia free, available / in 750ml & 5lt

TRUVUE770

GLASSSUPER5LT

Super glass leaves glass sparkling clean available in 750ml refillable trigger spray and 5lt container

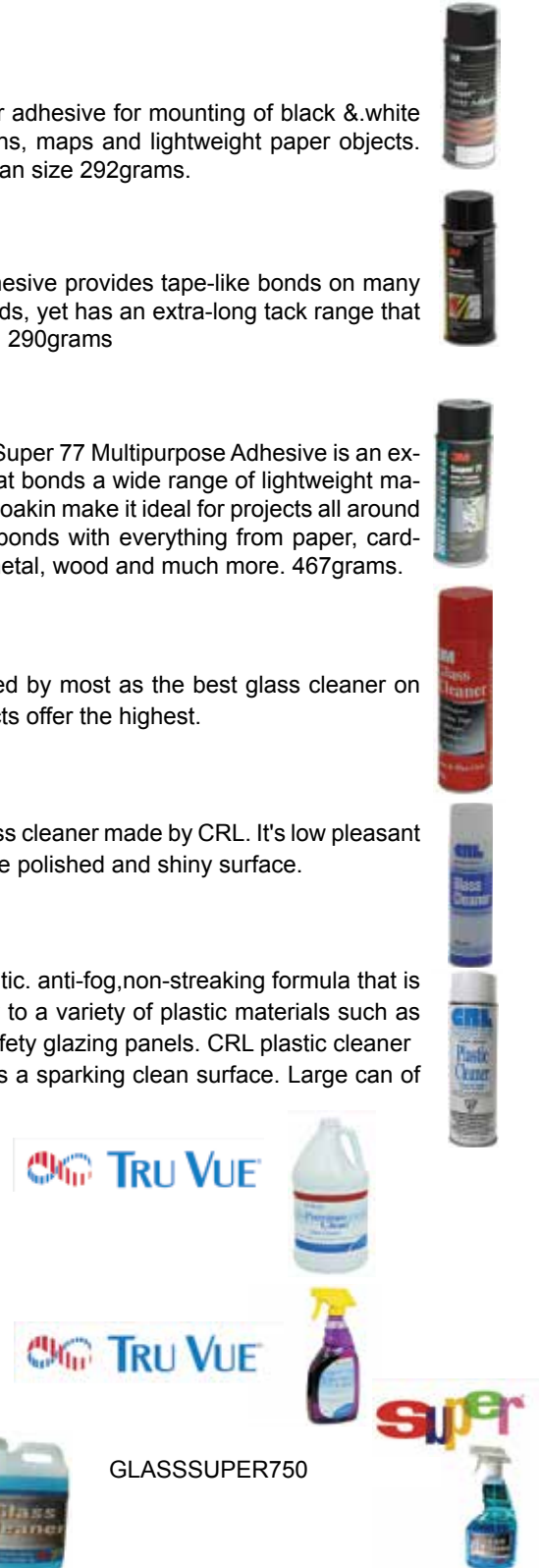

SOLO GLUE RITER® Replace double sided tape!

A simple squeeze bottle with a ball-and-spring valve that applies a thin film of adhesive for gluing matboard and dust covers. Refillable bottle holds 10 ounces and is available in 1/8" or 1/2" nozzle size. Our MATHE-SIVE glue is acid free and is available in quarts, gallons, 5-gallon pails & 55-gallon drums.*

Brushtex

This one step texturing process for posters, prints and pre-treated photos, is a great alternative to canvas transfers, and it eliminates the need for glass. No preparation is needed simply mount prints directly to illustration board or mdf. Do not use foamboard. Available in gloss in 1lt and 20lt sizes. Made in USA

BRUSHTEX (1 Litre)
BRUSH TEX20 (20 Litre)

Brushtex roller & brush

Brushtex can be brushed or rolled depending on the look

BRUSH TEX ROLL
BRUSH TEX BRUS



Desk tape dispenser

STDESKDISP MADE IN ITALY



Tapes

Kikusui backing tape

Kraft paper backing can be written on, aggressive adhesive, ideal for picture frame sealing. Seal out dust and insects. Aggressive adhesive that most consider to be the best in the industry. Made in Japan

- Codes: Kikusui Brown backing tapes**
- KT108B24 • Kikusui brown backing tape 24mm x 50mts
 - KT108B36 • Kikusui brown backing tape 36mm x 50mts
 - KT108B48 • Kikusui brown backing tape 48mm x 50mts
 - KT108B72 • Kikusui brown backing tape 72mm x 50mts

- Codes: Kikusui White backing tapes**
- KT108W36 • Kikusui white backing tape 36mm x 50mts
 - KT108W48 • KIKUSUI WHITE BACKING TAPE 48MM X 50MTS
 - KT108W72 • KIKUSUI WHITE BACKING TAPE 72MM X 50MTS

Stylus backing tape

Made in Japan

- Codes: Stylus Brown backing tapes**
- ST27072B • (72mm)
 - ST27048B • (48MM)
 - ST27036B • (36MM)
 - ST27024B • (24MM)

Flatback kraft paper tape sticks to itself & can be written on. Ideal picture framers tape with ph. Neutral adhesive. Available in sizes: 24mm, 36mm, 48mm & 72mm.

KIKUSUI TAPE 



stylus



Codes: Stylus White backing tapes

- ST27048W • (48mm)
- ST27036W • (36MM)

Flatback kraft paper tape sticks to itself & can be written on. Ideal picture framers tape with ph. Neutral adhesive. Available in sizes: 36mm & 48mm.

stylus



Kraft paper tape

Economical Backing Tape

- Code:**
KP4815 Brown tape 48mm x 15mt



Black Backing Tape

- Codes:**
TAPE BLACK25 (25mm)

TAPE BLACK 38 (38mm)

TAPE BLACK 48 (48mm)

TAPE BLACK 72 (72mm)

Description

Quality flat black, glossy black paper tape. Great for dust covers. This tape does not have any crepe to it for maximum adhesion. 55mt per roll.



Masking tape - Premium permanent masking tape

- Code:**
TAPE MT24MM
TAPE MT48MM

Description

Masking Tape 24mm x 50mt
Masking Tape 48mm x 50mt

hyStik



Lineco Burnishing Bone

- Code:**
LINECO BB8
- Description**
Burnishing bone for fine finishing of edges in picture mats. Eliminates rough edges caused by knife and makes overcuts less obvious. 8 inches long.



- Codes:**
ST72024CLOTH
25 mt per roll
- Stylus 720 Double sided cloth tape**
Premium grade cloth coated with an aggressive natural rubber solvent adhesive. Ideally suited for fixing linen or stitchery & various substrates. Tape removes easily cleanly & can be torn by hand.



stylus

Specialty Tapes

Codes:

ST740DS6

(6mm)

ST740DS9

(9mm)

ST740DS12

(12mm)

ST740DS18

(18mm)

ST740DS24

(24mm)

ST745DS9

(9mm)

ST745DS12

(12mm)

Stylus 740 Tissue Tape



Premium grade hand applied tissue tape coated with aggressive hi-tack acrylic adhesive. Ideally suited for picture framing & photographic industries because of its ph neutral adhesive. 33m per roll.

Made in JAPAN



Stylus 745 Tissue Tape



Hand applied tissue tape more economical version for when acid free is not needed. 30mt per roll, available in 2 sizes.



Kikusui Double Sided Tissue 190 hand applied



High performance acrylic adhesive made with Rayon paper tissue carrier for strength Excellent UV, temperature and solvent resistance also very thin and hand tear-able. Made in Japan

KT190DS6 6mm x 50mts

KT190DS9 9mm x 50mts

KT190DS12 12mm x 50mts

KT190DS18 18mm x 50mts

KT190DS24 24mm x 50mts

KT190DS36 36mm x 50mts

KT191DS12 12mm x 33mts



Kikusui extra heavy duty

Double sided adhesive polyester tape. Great for mounting ABS plastic offers secure bonds very high temperature. Good resistance to solvents, chemical UV + Heat.

KT16512 12mm x 33mts



TAPE ASAP7

Acid Free Hinging tape

White, self-adhesive, single sided acid free (PH7 neutral adhesive paper tape. Coated with an acid, free, water-based acrylic adhesive system. PH7-70 is ideal for hinging prints to mounts, dust proof sealing and other conservation and archival applications

Made in USA

TAPE ASA830

Strips Mounting

Self-stick conservation mounting strips offer an archival method of mounting prints and photos without having adhesive touch the art. Mounting strips will hold prints and photos up to 18in x 24inch. Strips are 100mm long.

Made in USA



Filmoplast p90 plus

Filmoplast p-90 plus is refined version of the original p-90 hinging tape and is especially designed for the picture frame industry. The p-90 plus gives better initial and final bonding strength while retaining the same aging characteristics that made the p-90 a favourite for decades.

Made in Germany

FP90PLUS 20mm x 50mtrs
acid free, lignin free paper tape.



Stitchery tape SPD1175 25mm x 55mt

0.32 mil PET film (hand tear-able) double coated with acrylic adhesive. Stitchery tape with non-yellowing, archival adhesive system. You no longer need to use staples, pins or glue for your tapestries. This tape will now permanently hold down and needlework to mdf or foamboard.

Made in USA



Duct Tape

suitable for sealing and joining applications
48mm wide x 50m on roll
TAPEDUCT



Tenacious tapes

Very high tack hand held tearable rubber adhesive with scrim reinforcement. Double sided.

TAPE H66612 12mm x 50m per roll

TAPE H66624 24mm x 50m per roll

TAPE H6669 9mm x 50m per roll



Framers Tape II Available in white & clear

Framer's Tape II - 1.9 mils PET coated with archival grade acrylic adhesive. low profile tape for heavy duty hinging, mending, mounting, repairing and reinforcing artwork, books and documents. Archival grade adhesive. Safely removes with minimal heat. Available in both clear and white.

Made in USA

SP2000WH (White) 25mm x 55mt

SP2000CL (Clear) 25mm x 55mt

SP2050WH (White) 50mm x 55mt

SP2050CL (Clear) 50mm x 55mt



White Neutral pH Adhesive

Neutral pH adhesive is used for artistic creations such as collages, adhering mats, objects within a frame and bookbinding. It is not recommended for attaching hinges to art. This PVA formula is pH neutral, has excellent lay flat properties, good open time and is quick setting. It will not become brittle with age and is remoistenable with water.



| Item No. | Description |
|----------|-------------|
| 901-1008 | 8 oz |

Bone Folder

These genuine cattle bone folders are used for making creases or folds on tapes and papers without causing the paper to become shiny. One end pointed, one rounded.

| Item No. | Size |
|----------|----------------|
| 870-901B | Large, 8" x 1" |



Document Cleaning Pad & Powder

Lineco's Document Cleaning Pads are recommended for cleaning dusty or dirty paper items. These pads contain a soft, grit-free powder that absorbs and cleans surface dirt from paper.

| Item No. | Size |
|----------|---------------------|
| 782-1004 | One Cleaning Pad |
| 782-1000 | 2 lb. can of powder |



Museum Mounting Kit

Original Japanese Paper & Wheat Starch

Everything you need to make traditional museum quality mounts: wheat starch adhesive, medium weight mulberry paper, blotters, polyester separators, mat hinging tape and instructions.

Item No. L533-2000



Self-Adhesive Polypropylene Corners

Lineco polypropylene corners provide extra strength and sizes to accommodate larger art pieces. They are safe, and acid-free. The full view variety minimizes the border required to hide the corner under the window mat. Use for light to heavy weight photos and art.

PAT
PASSED
ANSI
ISO 18916

| Item No. | Size | Qty/Pkg |
|-----------|------|---------|
| L533-0036 | 3" | 100 |

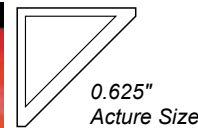

1.25" & 3"

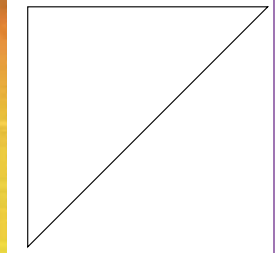

Self-Adhesive Volara® Foam Rabbit Tape

Line frame rabbets to provide padding and a slippery surface to protect canvas transfers, digital art and oils from sticking to the wood rabbit. Volara® is an acid free, closed cell, inert polyethylene foam coated with a stable acrylic adhesive.

| Item No. | Size |
|----------|-------------------------------|
| 018-1436 | 0.25" x 108 ft. x 0.03" thick |



Self-Adhesive I-Film™ Frame Sealing Tape

Polyethylene is imbedded with a Corrosion Intercept® Technology copper matrix and coated with strong acrylic adhesive. The Corrosion Intercept® matrix stops acid, corrosive gases and retards mildew and mold. I-Film™ is flexible, strong and puncture-resistant for easy application. Strong adhesive sticks to raw wood. Use I-Film™ for sealing raw wood fillets, rabbets, frame backs and frame packages to protect from acid migration, corrosive gasses, mildew and mold.

NEW!

PAT
PASSED
ANSI
ISO 18916

| Item No. | Size |
|----------|----------------|
| 034-2000 | 1.25" x 85 ft. |





See-Thru Mounting Strips

Lineco See-Thru Mounting Strips are made from conservation quality materials. Clear polyester is bonded to a 2 ply mat with a self-adhesive back. Simply position the artwork and adhere the strips to the mount board. No adhesive touches the art. Accommodates larger art and can be cut to smaller sizes for a particular job. See-Thru strips provide several advantages over corners; a few along the bottom provide full length support, application is easy, the art stays flat, and the strips are applied around the edges. The polyester may be trimmed to hide the strip with borders as small as 1/8".

| Item No. | Size | Qty/Pkg |
|-----------|------|---------|
| L533-4015 | 4" | 60 |

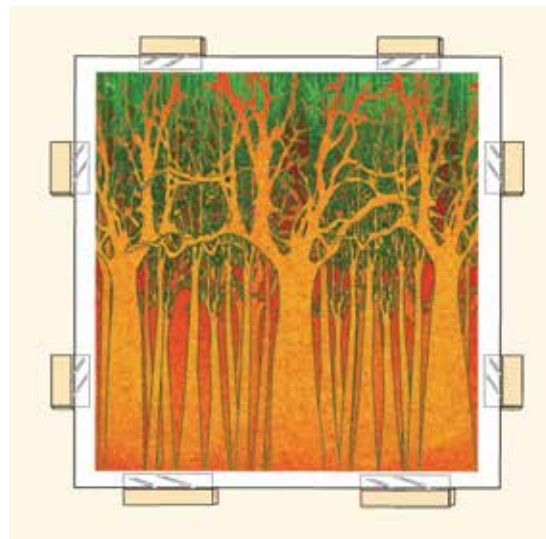

Gummed Linen Hinging Tape

Great for heavy water-colors or collages. The 65/55 thread count, acid-free fabric gives plenty of strength. The high tack neutral pH adhesive sets fast and lays flat.

| Item No. | Size |
|-----------|----------------|
| L533-1025 | 1" x 30 ft. |
| L533-2020 | 2" x 300 ft. |
| L533-1520 | 1.5" x 300 ft. |
| L533-2020 | 2" x 300 ft. |
| L533-1050 | 1" x 150 ft. |



Self-Adhesive Linen Hinging Tape

A favorite for hinging window mats to backboard or attaching art. The very fine linen cloth is flexible yet strong. The neutral pH acrylic adhesive gains strength overnight.

| Item No. | Size | Color |
|-----------|-----------------|-------|
| L533-1055 | 1.25" x 150 ft. | White |
| L533-1015 | 1.25" x 35 ft. | White |

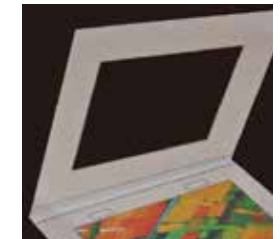

Document Repair Tape

Same as the Transparent Mending Tissue but 1" wide for larger repairs. It is a favorite of both conservators and collectors. Easy to use, just place over tear and burnish with bone folder.

| Item No. | Size |
|----------|------------|
| 533-0198 | 1" x 98 ft |

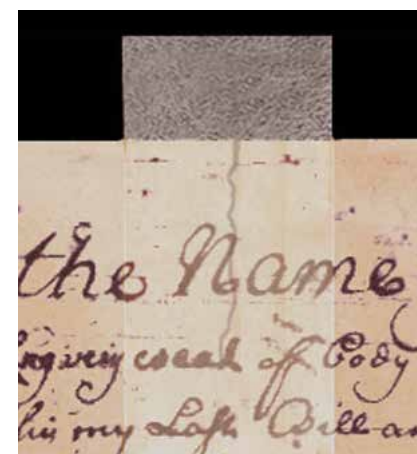

Fillet Tape - TAPE ASA600

A double-sided polyester tape with an acid-free, acrylic system. The polyester is 0.22mm thick and acts as a great barrier in stopping acid from penetrating from the wooden fillet to the mount. The acid-free adhesive won't yellow. 50mts per roll. Made in USA



TAPE K330WH18

Exhibition approved cloth strong hand tape that removes cleanly no residue. 33m per roll

3M hand applied tissue tape

3M907512 3M double sided acid free hand applied tissue tape.

3M907518 50Mts per roll



Made in USA

3MMAGIC810

3MMAGIC810L 3M 810 acid free magic tape 19mm x 65mts

3MMAGIC810 3M 810 acid free magic tape 12mm x 33mts



Magnet Tape

For use on the back of your samples when using colourbond wall. 3m tape.

MAGNET12 (30mts per roll) 12mm

MAGNET25 (30mts per roll) 25mm



ATG Tapes

3MATG12 (3M 12mm)

3MATG19 (3M 19mm)

3M ATG 924



Aggressive, general purpose 2-mil adhesive, bonds instantly for permanent double matting, dust covers, mounting and attaching decorative papers and fabrics.



MADE IN ITALY
STATGHT12 (12mm 16.5mts)

Stylus Permanent High tack ATG

Hi-tack acrylic adhesive transfer tape suitable for permanent bonding applications. U.V. stable & pH neutral. ideally suited for use in picture framing, photographic & merchandising industries. Sizes: 12mm x 16.5m.



MADE IN ITALY
STATGP6 (6mm)

STATGP12 (12mm)

STATGP18 (18mm)

Stylus Permanent ATG

General purpose acrylic adhesive transfer tape suitable for permanent bonding applications. U.V. stable & pH neutral. ideally suited for use in picture framing, photographic & merchandising industries. Sizes: 6mm, 12mm & 18mm 33m per roll



MADE IN UK

TAPE ASA2305 (12mm)

TAPE ASA2315 (19mm)

Eurotrans ATG

This product is white in colour and available in 2 sizes, has an acrylic adhesive system which allows you to reposition your product if needs be, before you apply pressure for your final bond. 33m per roll.



3m ATG 908 TAPE (12MM)

MADE IN USA



3M's acid free ATG 908 tape has the "neutral" qualities you need to protect and preserve your valuable artwork, delicate documents, cherished photographs and much more. It goes on clear, stays clear and is safe for virtually any project.



TAPE ASAATG12A

MADE IN USA



Asa ATG tape. Very strong acid free ATG tape/12mm x33m per roll



Edging Tape

Designed for edging foamboard and/or gatorboard to give a well finished look where framing is not required

TAPE 530BK20 black paper edging tape 20mm x 25mt on roll

TAPE 530WH20 white paper edging tape 20mm x 25mt on roll



Bostick Glue

GLUE 4279 BOSTICK427920L Bostick/Anchor Weld-4729 for laminating artwork.

GLUE WHITE BOSTICK45020L Bostick/Anchor Weld water based for joining frames.

GLUE BOSTICKDHESIVE Anchor Weld/bostick Adhesive Glue in Yellow and Red packaging

BOSTICKV60 Silicone Glue

Acid free silicon for mounting medals, mirrors or objects.



Rolltaq

Rolltaq 300 adhesive system rolls on a wide 2 1/4 inch adhesive strip. Makes mounting quick and easy. Acid free, non-toxic. Free bottle of adhesive enclosed.

M300 Hand held applicator



JAC Paper Double Sided Adhesive

A solvent based adhesive paper. Used for sticking photographs or prints to board. 762mm x 1000mm



Rubber Roller

Tough black rubber roller with a heavy duty plastic handle. Ideal for mounting down prints, poster or artwork. They come in a 6" (150mm) and 8"(200mm) size

ROLLER 6 150mm (6inch) gluing rubberized roller

ROLLER 8 200mm (8inch) gluing rubberized roller



Glue for hot glue machine

Motorized roller coaters

Automatically warms up to the proper temperature in about 55 minutes. Press the motor switch, feed your print into the turning rollers and the print automatically receives a smooth, even adhesive coating. Runs at 4 seconds per feet. Heat will not effect inkjet or laser jet prints. No daily or monthly maintenance. Available in 36 1/2" coating widths.



MXG11-7

The MX II adhesive is designed to provide unsurpassed adhesion to just about any surface. You only need a very thin coating to obtain a proper bond. After coating the media, the adhesive never dries out, so you can mount at any time. MSII will stick to gastrofoam, sintra, wood, metal and most other surfaces. It is completely safe to use and is non toxic and non hazardous. Refills comes in pellets in dissolvable cello bags. MADE IN USA

Glue for cold glue machine

G128S2 5 Litre glue for cold roller glue applications



Atg Pick Up

ATG PICK-UP
REMOVES EXCESS
DOUBLE SIDED TAPE
& OTHER ADHESIVES



Scapa ATG tape

TAPE ATG60
(12mm 50mt roll)

Is an acid-neutral (pH 7) acrylic transfer adhesive with high initial tack, ultimate bonding power and excellent UV resistance.

TAPE ATG36
(12mm 30mt roll)

Made in Switzerland



Kikusui ATG tape

456 + 459 Reverse Wound Transfer Tape
High strength acrylic adhesive that has a transparent adhesive film. Excellent adhesion to most papers and films. Made in Japan.

KT456ATG12 Kikusui double sided tape atg 12mm x 33mts
KT456ATG18 Kikusui double sided tape atg 18mm x 33mts
KTG459ATG12 Kikusui double sided Acid free 12mm x 33mts
KTG459ATG18 Kikusui double sided Acid free 18mm x 33mts
459 same tack as 190 tape

KIKUSUI TAPE

Tape Guns

3M ATG GUN

3m originally designed the ATG system so it seems fitting that they have one of the best guns around. The gun can take both the smaller 33mts roll or the larger 55mts roll therefore saving time in changing roll. This gun is for the hobbists or the production framer and will give many years of service with its high quality gearing system.

ATGGUN 3M Scotch ATG-700

ATG tape gun for 12/19mm tape MADE IN USA



ATG Adapter

ATG ADAPTER

Adapter for 6mm tape



Stylus ATG gun

MADE IN ITALY

STATGGUN

stylus

Stylus ATG gun for 12 & 19mm tape



Adhesives

Eva Glue

Our EVA glue is of a very high quality. It contains no less than 56% solids. EVA glue, can be rolled, brushed or sprayed on. Its ideal for mounting down, prints, posters and artwork. Suitable for mounting onto photos, boards or paper. EVA can be removed with heat. It has been a favourite with framers for years

EVA 5 EVA Glue 5lts

EVA 20 EVA Glue 20lts



PVA glue

Our PVA glue is a great wood working glue. It is highly concentrated and has over 50% solids

PVA 500 PVA Glue 500ml

PVA 5 PVA Glue 5lts

PVA 20 PVA Glue 20lts



Synthetic Glue

Our synthetic glue was specifically designed to join synthetic mouldings together. This glue dries off very quick and also melts the synthetic fibre together giving a very superior join. It is considered by many the best synthetic moulding in the industry. MADE IN AUSTRALIA

GLUE500ML

Synthetic glue for bonding plastic mouldings 500ml

GLUE 20LT

Synthetic glue for bonding plastic mouldings 20lt



Black Magic 473ml

Black PVA glue

Great for using when joining dark and black mouldings.



SPACERS

FrameTek frame space



FT FS2C

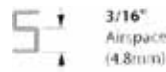

FS-2
Clear,
100 ft. bundle
20 - 5 ft. pieces
Fits 2mm glass &
3mm acrylic

(30.4mt)

FT FS3-2MMC



FS-3-2mm
Clear,
60 ft. bundle
12 - 5 ft. pieces
Fits 2mm glass

(18.2 x mt)
(1.52mt)

FT FS6C



FS-6
Clear
100 ft. bundle
20 - 5 ft. pieces
Fits 2mm & 2.5mm glass

(30.4 x mt)
(132mt)

FrameTek econospace

FT ES062C (clear)

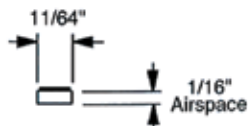

ES-062
Clear
100 ft. bundle
20 - 5 ft. pieces

1.6mm airspace
(30.4mt)
(1.52mt)

FT ES062B (black)

FT ES125C (clear)

FT ES125B (black)

FT ES125W (white)

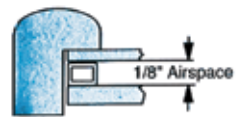

ES-125
Clear, Black & White
100 ft. bundle
20 - 5 ft. pieces

3.2mm airspace
(30.4mt)
(1.52mt)

FT ES250C (clear)

FT ES250B (black)

FT ES250W (white)



ES-250
Clear, Black & White
60 ft. bundle
12 - 5 ft. pieces

6.3mm airspace
(18.2 x mt)
(1.52mt)

FT ES375C (clear)

FT ES375B (black)

FT ES375W (white)

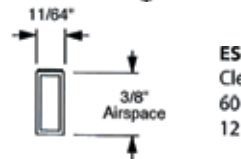

ES-375
Clear, Black & White
60 ft. bundle
12 - 5 ft. pieces

9.5mm airspace
(18.2 x mt)
(1.52mt)

FrameTek Rebbet Space

FT FT RS1/8



1/8"
Additional
Space
(3.2mm)

RS 1/8
35 ft. bundle
7 - 5 ft. pcs.
Includes 150 screws

FS FT RS 1/4



1/4"
Additional
Space
(6.5mm)

RS 1/4
35 ft. bundle
7 - 5 ft. pcs.
Includes 150 screws

FS FT RS 3/8



3/8"
Additional
Space
(9.5mm)

RS 3/8
35 ft. bundle
7 - 5 ft. pcs.
Includes 150 screws

FS FT RS 1/2



1/2"
Additional
Space
(12.7mm)

RS 1/2
35 ft. bundle
7 - 5 ft. pcs.
Includes 150 screws

Touch Up supplies

Gilders paste - Made in USA



Gilders Paste

A blend of superior waxes, resins, high concentrations of light-fast pigments that will dry completely with no tacky residue. Available in 28 colours to mix together to produce an endless colour palette. Dries to the touch in 15 minutes and completely dry in 12 hours. Adding a few drops of paint thinners will rejuvenate Gilders Paste providing a longer shelf life and no waste. Minor repairs, scratches and miter joints, touch up or a complete finish and more.



Amaco nail filler is non toxic, its applicable filler for crack and nail holes. We carry 14 popular colours. 56gram tin



Matisse structure is an ideal product for colouring to make joints look incognito

Touch up markers

ChartPak markers are ideal for touching frames as well as concealing join lines, they are spirit based and the tip has three strokes

Fine, medium and broad. They are made in the USA. They can be sold individually or in a pack of nine stains colours

Sold individually. MADE IN USA

| | | | |
|------------|---------------|------------|-----------------|
| PENFTM0 | Blender | PENFTM54 | dark walnut |
| PENFTM58 | dark oak | PENFTM60 | walnut/mahogany |
| PENFTM69 | dark cherry | PENFTM70 | medium oak |
| PENFTM74 | medium cherry | PENFTM86 | red mahogany |
| PENFTM99 | black | PENFTM139 | light oak/maple |
| PENFTM148 | light pine | PEN FTM105 | ice blue |
| PEN FTM137 | beige | PEN FTM142 | sand |
| PEN FTM183 | cool gray 3 | PEN FTM186 | cool gray 6 |
| PEN FTM198 | warm gray 8 | | |



Chartpak®

Creativity. Our Legacy.™

Chartpak®

Creativity. Our Legacy.™

PEN FTM9 Pack of 9 colours

| | |
|--------|-----------------|
| FTM54 | dark walnut |
| FTM58 | dark oak |
| FTM60 | walnut/mahogany |
| FTM69 | dark cherry |
| FTM70 | medium oak |
| FTM74 | medium cherry |
| FTM86 | red mahogany |
| FTM139 | light oak/maple |
| FTM148 | light pine |

MADE IN USA



Sakura Touch Up Pens



High quality white gold & silver, lays out opaque marks on most papers & non-porous surfaces. Adheres permanently to most surfaces, low odour, quick drying and xylene free. 2mm thick. Made in Japan Available in 3 colours:

PEN FTM41501-GOLD

PEN FTM41502-SILVER

PEN FTM41500-WHITE



Rub 'N' Buff



Rub "N" Buff can be used for antiquing or decorating ANY surface. Apply sparingly with a soft cloth. Rub longer for glossy effect.

RUBANTIQUEGOLD



RUBSILVERLEAF



Mirotone

Satin clear laquer great for evening out marks on mouldings.

MADE IN ASUTRALIA



Mohawk canvas finish aerosol

Clear spray laquer especially designed to protect printed wide format canvas both cotton and polyester. Very fast drying and increase resistance to scratches, abrasions and finger marks. Use in a well vented area applies in a cross hatch pattern and if cleaning is required you may use thinners. Store at 20celcius. Dries to a satin finish, Always test first.

365grams nett

Canfinsatin



Aluminium Accessories

Our quality accessories are made from high quality steel.
 Our rubber gaskets are designed as a wedge to make sure the picture does not move after framing.
 For your convenience all the gaskets are cut to 50mm long so they are ready for use.

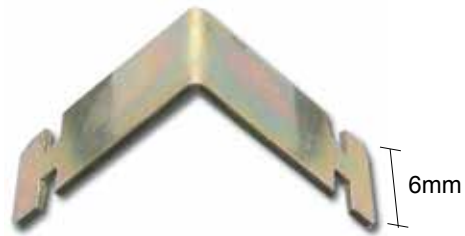

CNRSTAK (PF5)

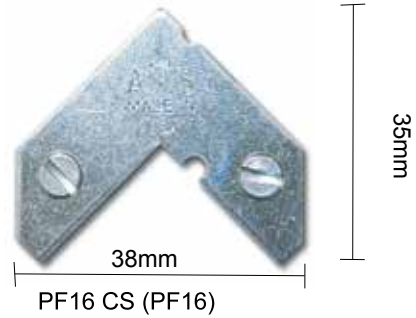

PF16 CS (PF16)



HARDWARE (PF6 & PF7)

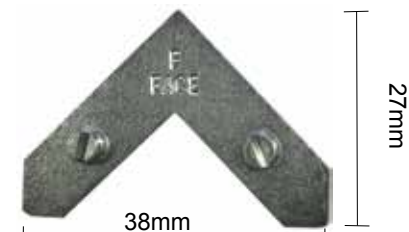

HARDWARE HEADLESS
 SET INC Screws
 Screws(3J) also sold Separately



PF16 BP (PF16)

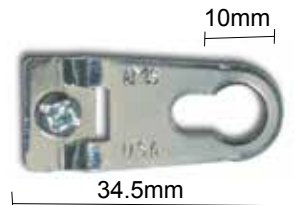

EUROHANGP6/7

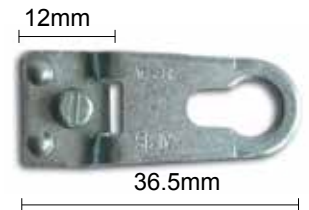

PF16 EH (PF16)



DRING NUT &
 SCREW (PF6 & PF7)
 (DRING SET)

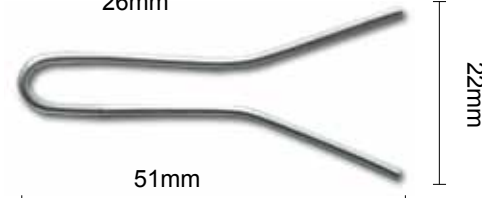

HAIR CLIP HANGER (PF6 & PF7)



FILLER SPRING (PF6 & PF7) (RETCLIPS PF7)

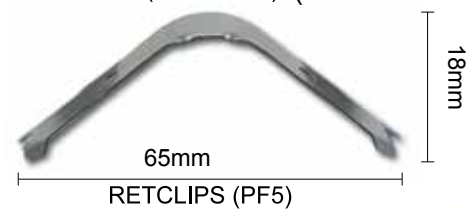

RETCLIPS (PF5)

CWH3





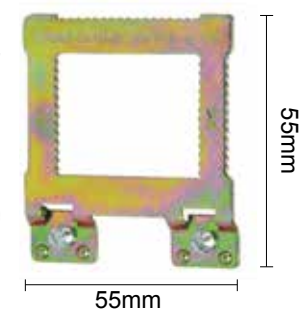



SQUARE HANGER
 FOR PF16 ALUMINUM
 ADJUSTABLE WITH 2 SCREWS



55mm

Rubber Gaskets

| | | | |
|-----------|---------------------|------|--|
| F45 - 195 | 195 Thin gasket | 5000 |  |
| | | | F45-195 |
| F45 - 225 | 225 Thin gasket | 3000 |  |
| | | | F45-225 |
| F45 - 250 | 250 Thin gasket | 3000 |  |
| | | | F45-250 |
| F45 - 270 | 270 Standard gasket | 3000 |  |
| | | | F45-270 |
| F45 - 290 | 290 Standard gasket | 3000 |  |
| | | | F45-290 |
| F45-305 | 305 Thick gasket | 3000 |  |
| | | | F45-305 |
| F45 - 355 | 355 Thick gasket | 3000 |  |
| | | | F45-355 |

Canvas Offsets

Canvas off sets are an easy way to attach stretched canvas to picture frame mouldings.

They can be easily and quickly be removed without leaving and unsightly look.

- CAN3 Canvas Offsets 3mm
- CAN6 Canvas Offsets 6mm
- CAN9 Canvas Offsets 9mm
- CAN12 Canvas Offset 12mm
- CAN18 Canvas Offset 18mm
- CAN25 Canvas Offset 25mm
- CAN31 Canvas Offset 31mm

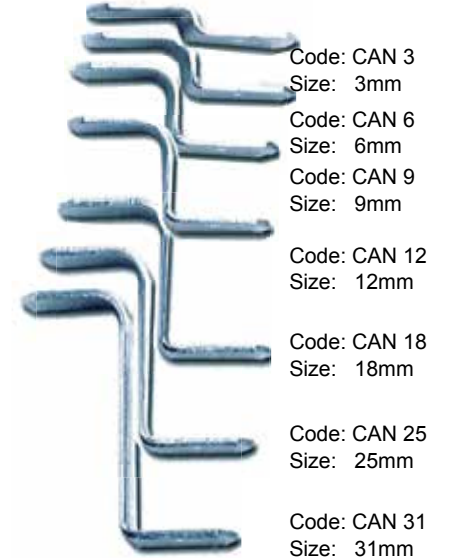

- Code: CAN 3
Size: 3mm
- Code: CAN 6
Size: 6mm
- Code: CAN 9
Size: 9mm
- Code: CAN 12
Size: 12mm
- Code: CAN 18
Size: 18mm
- Code: CAN 25
Size: 25mm
- Code: CAN 31
Size: 31mm

HAND TOOLS
Glazing accessories

TOYO® Comfort-Grip Supercutter® With Wide Head has a lightweight, tapered acrylic barrel with contoured finger channels designed to fit all hand sizes. It is among the best in the industry. Known for its long wheel life, this cutter was built to last, and make the cleanest scores in glass cutting today.

Cutter has a precision ground cutting head and an automatic oil-feed system with carbide wheel. The plastic handle also allows you monitor the cutting fluid.

The wide head is great for production cutting while using a straight edge level.



toyohh **Toyo Glass cutter**
This TOYO Pistol-Grip Supercutter® Straight Head Glass Cutter gives you an outstanding control of your cut with its pistol grip handle while hand strain is minimized. It is designed for hours of fatigue-free cutting, and features a self-lubricating head fed by an oil reservoir in the handle. The wide cutting head is great for use with a straight edge for those repeat cuts. Known for its high quality, this cutter is built to last and make the cleanest of cuts. An automatic oil dispensing system keeps the wheel lubricated every time you cut. Cutting wheel hone angle is 140 degrees. These are made in Japan



FLETCHERWHITEGLASS
Fletcher gold tip designer II brass glass cutter hand held
Made in USA

LOGAN 704
A hand held glass cutting tool using a hardened steel wheel with ergonomic handle.



LOGAN 440

The original logan hand held logan mat cutter heavy duty pull.



Glass Pliers

These popular CRL 8" Drop Jaw Glass Pliers have a flat upper jaw that supports the top surface of the glass, while the humped lower jaw develops powerful leverage under slight pressure, and cleanly severs the glass at the cut line. Maximum glass thickness is 1/2" (12 mm), and the overall pliers length is 8" (203 mm).

Glass Pliers 8



Fletcher pliers



Plastic anvils for accurate alignment with score line for easy breakout interchangeable hardened FLETPLIERS 8 steel jaw to break out narrow trims.



Diagonal Pliers

PLIERSDIAG5 125mm diagonal pliers



Glass File

For smoothing and swiping freshly cut glass edges using a Glass File is a quick and easy method to smooth edges and corner of recently cut glass. It removes sharp edges enabling a glazier to handle the glass safely.

FILE GLASS With two abrasive rollers



Fletcher Pull Mate

The pull mate is a handy tool for quick and easy removal of Fletcher Framer's points from wood frames. The noted end of the PullMate fits over the point provide a tight grasp for pulling.

FLETPULL Fletcher Pull Mate 09-517



Fletcher Spring Mate



Fletcher spring mate makes easy work of inserting and removing spring clips from metal frames. Just slip the slotted end of the SpringMate over the spring and twist to flatten spring to insert or remove frame.

FLETPRING Fletcher Spring Mate 09-519



Fletcher Score Master



Score Master Plastic Cutter, Double edged plexiglass scoring tool, Two tips for normal and extra pressure.

FLETSCORE-MASTER
Fletcher score master 05-111



Snappy Hooker

Great for slitting paper, cellophane and films. Cannot cut yourself.

SNAPPY HOOKER

Includes 2 injector blades



Speed glass cutters

This glass cutter is a T-bar set up and allows you to cut accurately without using a ruler. It comes in three sizes 680mm, 1280mm, 1880mm

SC680 Speed Cutter 680 mm

SC1280 Speed Cutter 1280 mm

SC1880 Speed Cutter 1880 mm

SC CUTTER Self lubricating cutting head for speed cutter

SC WHEEL Extra wheels for speed cutters



Speed cutter

Fletcher Oval Cutter



FLETGLASSOVAL

glass cutter cuts oval and circle from 114-610MM



LOGAN 701

Product Features / Highlights: pull-type 90-degree cutter three depth settings with slip lock blade change feature sizes standard thickness matboards and foamboard up to 3/16" (4.7 mm) can mount to many Logan board mounted cutters and straight edges

Product Description:

Pull type 90-degree straight cutter has comfortable 3"(7.62cm) ergonomic handle. Features an adjustable depth pivot cutting action. Use with any suitable straight edge. Three depth settings: safety, single sheet, and 3/16" (5 mm) foam board. The Straight Cutter Elite is ready to be instantly added on to Logan Adapt-A-Rule, Logan Team System, Logan Compact, Logan Artist Elite, Logan Simplex Plus, Logan Simplex Classic and Logan Simplex Elite series. Includes five mat cutter replacement blades. Uses Logan 270 blade.



LOGAN 2000

Product Features / Highlights:

retractable blade start-and-stop indicator

Product Description:

The Logan Push Style handheld mat cutter includes a retractable blade. The blade slot prevents blade flex, resulting in straighter cuts. A start-and-stop indicator helps to eliminate over cuts. Can upgrade for use on the Adapt-A-Rule straight edge and Compact or Simplex Series board mounted mat cutting systems. Uses Logan 270 blade.



Stretching Pliers



Fredrix Stretching Pliers

Made from chrome plated drop forged steel these heavy duty canvas pliers come with a spring loaded handle for the stretching of canvas.

NAM2090030010 Fredrix Canvas Pliers Silver



Holbein stretching pliers

Light but strong Molydernum pliers with rubber grips. 4-1/2" (12cm) jaws with Urethain cushions to prevent slippage these are of very high quality and are made in Japan, the rubber grips are also replaceable

NAM2090020040 Holbein Canvas Pliers
MADE IN JAPAN



NAM2090020042 Holbein rubber jaws

CUTTING

Keencut cutting

MADE IN UK

Blades



Matt cutting blades

CA50/003 Standard cutting on Oval 6 & Rondo
Pack of 100



CAS50/010 VC-Ultimate Gold, Ultimat & Artist + Fletcher Terry Machines (080 Blades)
Pack of 100



CA50/017 For bevel cutting standard mat board on the Ultimat Gold, Ultimat, Fletcher Terry machines (Tech-D .012)
Pack of 100

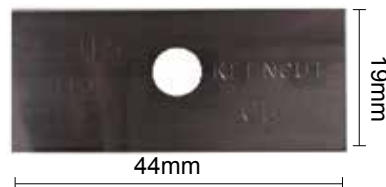

CA50/021 For bevel cutting white-core & conservation mat board up to 3mm on the Ultimat Gold, Ultimat, Fletcher Terry machines (Tech-s .012)
Pack of 100



CA50/020 For bevel cutting soft thicker boards (foam centred board) on the Ultimat Gold, Ultimat, Fletcher Terry machines (Tech-s .015)
Pack of 100

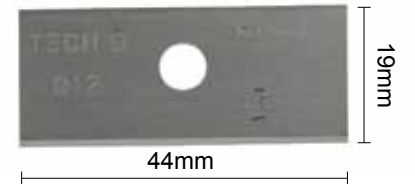

CA50/030 For bevel cutting white core & conservation mat board over 3mm on the Ultimat Gold, Ultimat, Fletcher Terry machines (Tech-D .015)
Pack of 100



Fletcher cutting



FLET D13012 Fletcher super keen-double edges. Thickness .015 Mat blade. Quantity 100 per box to suit F2100 & F2200 (05-015)

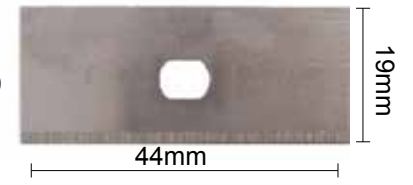

FLET D13015 Fletcher super keen-double edges. Thickness .015 Mat blade. Quantity 100 per box to suit F2100 & F2200 (05-016)

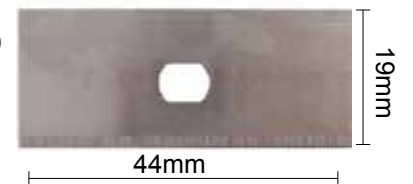

FLETCHMATT3000 Fletcher mat blades 05-001 tube of 10

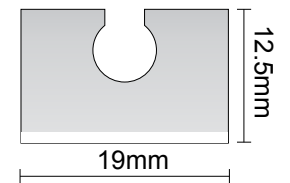

FLETPLASCUTT



Fletcher F3100 steel replacement blades-plastic cutting to suit F1300 (10 per box) 05-712



FLET 3100WHEEL

FLETCHER

3100/3000 hardboard wheel set

05-715



FLETBEARING

FLETCHER

12-215

for use in F3100/3000



FLETMATBLADET

FLETCHER

Mat blade for 05-004

for use in F3100



Keencut glazing



KCCA50/015

tungsten carbide metal
black glass cutting wheel
for the excalibur
for use in 5000 and 1000

made in UK



KCCA50/018

tungsten carbide plastic glass
cutting wheel for use in
Keencut system4000

made in UK

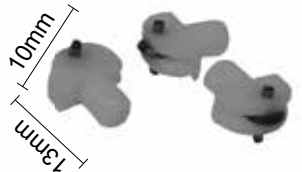

Fletcher Terry Glazing

FLETCHER

FLETGLASSWH

Fletcher F3100 steel 120
glass cutting wheels
(02-120) (10 per tube)



FLETCARBIDWH

FLETCHER

Fletcher F3100
carbide 124 degree wheel (each)
(03-126)



Saw Blades

SAW30096 300 OD x 30 bore size with 96 teeth

SAW35096 350 OD x 30 bore size with 96 teeth

SAW355120 355 OD x 25.4 bore size with 120 teeth

SAW40096 400 OD x 30 bore size with 96 teeth



ZIPPY CUTTER

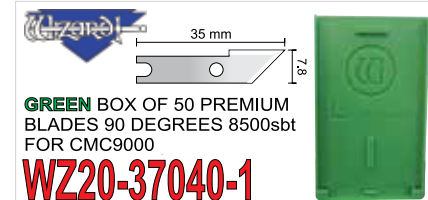

GREEN BOX OF 50 PREMIUM
BLADES 90 DEGREES 8500sbt
FOR CMC9000

WZ20-37040-1

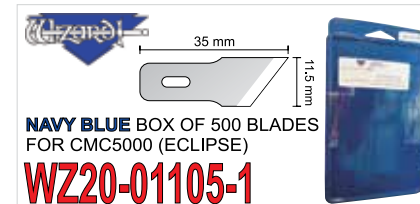

NAVY BLUE BOX OF 500 BLADES
FOR CMC5000 (ECLIPSE)

WZ20-01105-1

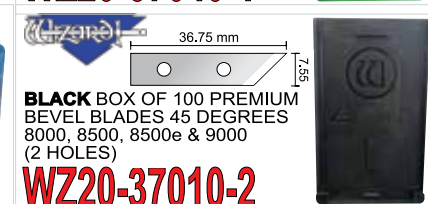

BLACK BOX OF 100 PREMIUM
BEVEL BLADES 45 DEGREES
8000, 8500, 8500e & 9000
(2 HOLES)

WZ20-37010-2

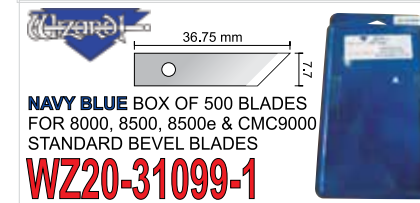

NAVY BLUE BOX OF 500 BLADES
FOR 8000, 8500, 8500e & CMC9000
STANDARD BEVEL BLADES

WZ20-31099-1

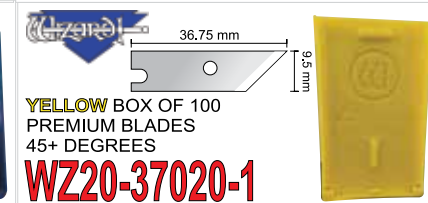

YELLOW BOX OF 100
PREMIUM BLADES
45+ DEGREES

WZ20-37020-1

Zund Blades



BLADESZUNDI Zund CMC mat cutter blades internal
5 blades per pack

BLADESZUNDE Zund CMC mat cutter blades external
10 blades per pack

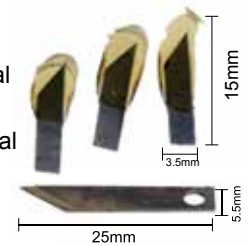

Brevetti Blades



MADE IN ITALY

BR275-32 wood cutting blades 275mm diameter 32mm bore

BR350-32 wood cutting blades 350mm diameter 32mm bore



WAX STICK

For lubricating saw blades when cutting aluminium
mouldings. Minimises heat & prolongs blade life



everyday accessories

Guillotine blades

These high quality guillotine blades are made to suit Framers comer, Morso and Cassese Guillotines

- GUILLOBLADES Guillotine blades to suit most popular brands. Morso, Jyden, Hansen etc. MADE IN TAIWAN
- GUILLOCASSESE Guillotine blades for cassese
- GUILLO JYDEN Standard Blades for jyden/schlecher. Made in Denmark. Excellent quality.
- GUILLO HANSEN-MORSO Standard Blades for Hansen-morso. Made in Denmark. Excellent quality.
- GUILLOWOOD Wooden Storage Box for guillotine blades



Enviro Gold



- FLETENVIRO Glass cutting fluid for optimum cleaning, extends life of a cutting tool

Snap Cutter & Blades

- BLL1 Olfa 18mm large snap cutter, High quality-Made in Japan, metal insert, screw lock Made in Japan
- BLLB10B Olfa 18mm large snap cutter, High quality-Made in Japan, Carbon Steel 110 x 18x 0.5mm, Tube of 10 Made in Japan
- BLLB50B Olfa 18mm large snap cutter, blades, High quality-Made in Taiwan
- BLCYM560 18mm large snap cutter, metal insert, screw lock
- BLA11 18mm large snap cutter, blades, High quality-Made in Taiwan
- BLA09 Stanley type retractable knife
- BL975.064 Heavy duty utility blades,high quality Made in Germany 60 x 19 x 0.63mm, Box dispenser of 10
- BLB12 Hobby/art Knife, all metal construction non-slip rubber grip handle safety cap



- BLB13/10 Hobby blade, carbon steel 399 x 8.5 x 0.53mm, Tube of 10 to suit BLB12
- BLA07 Persona utility blades, 100 per pack
- BLSN02 9mm small snap cutter blades, sharp angle 85 x 9 x 0.38mm, Tube of 10
- BLA49 Extra heavy duty 25mm Snap cutter with non slip rubber grip & screw lock suits BLA49BL blades
- BLA49BL 25mm Large snap cutter blades extra heavy duty 140 x 25 x 0.5mm 10 per tube

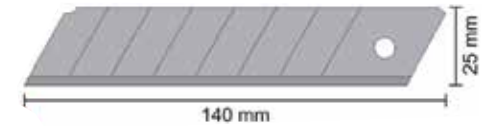
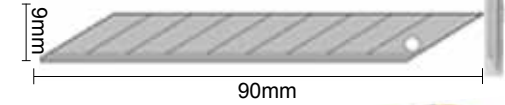
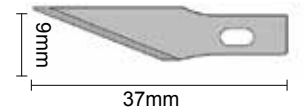

Snap off blades

- SNAPOFK Large snap off knives
- SOBLADES Large snap off blades



Quickblade Autoloading Retractable Knife

- AMCOBA375 Our Quickblade retractable autoloading knife requires due to its one-button blade change mechanism. This blade cutter uses any standard utility blade. 5 blades are included with each package.
- AMCOBD325 Quickblade autoloading + 5 blades



Tape Measure

- TAPEM3 tape measure, rubber grip 39 x 8.5 x 0.53 mm APM Moulding Tape measure 3 metre



Scissors

- SCISSORS29810 220mm black panther scissors soft comfortable handle stainless steel, 10 year guarantee. Made in Taiwan
- SCISSORS78407 8IN SMOOTH BLADE SCISSORS precision Made in Italy
- SCISSORSTSS10 10 inch stainless steel precision tailoring shears Made in Italy



Straight Edge

Keencut safety straight edges



This straight edge is the most professional straight you will ever see. It is made from a heavy gauge of aluminium.

The base has two silicon rubber grip strips. It has both metric and imperial measurements and you can find centre or measure as normal from the edge

Safe to use the straight edge has an integral finger guard and a full-length stainless steel bead to resist wear to the edge and the tools.

Available in 4 sizes

| | |
|------------|------------------------------|
| KCKS20/000 | 450mm Keencut straight edge |
| KCKS23/000 | 900mm Keencut straight edge |
| KCKS27/000 | 1500mm Keencut straight edge |
| KCKS28/000 | 1800mm Keencut straight edge |



Self Healing Mat

Self healing cutting mat has grids on it to help ensure that films, laminates & prints are cut to specification. These grey coloured mats are thick and strong to protect cutting surfaces, Make excellent ever lasting desk tops, with non-glare and non-sliding surfaces that are impervious to spills & cuts.

CM2F 24" x 36" (610mm x 915mm)
self healing cutting mat

CM2K 39" x 59" self healing grey

CM2L 39" x 78" self healing grey

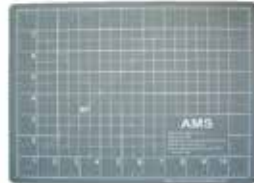

Rulers

RULER-45 DEGREE For measuring accurate metres

RULER600 Stainless steel ruler 600mm/24 inches both metric & imperial

RULER1M Stainless steel ruler 1000m metric only



Point drivers and points

FLEXI GUNS PNEUMATIC & MANUAL

CODE Description

BANTAMS Taurus Bantam S Tabber (Pneumatic)



Cassese Spares

| | |
|---|--|
| CASSZ1813 SUITS CS59, CS70, CS88, CS89, CS179, CS289, CS495, CS495, CS830, CS910, CS3099 & CS4008 | CASSZ52 124 mm SUITS CS276 & CS810 PRO TURNER |
| CASS2506 60 mm SUITS CS59, CS70, CS88, CS89, CS179, CS289, CS495, CS495, CS830, CS910, CS3099 & CS4008 | CASSZ1804 45 mm SUITS ALL MODELS EXCEPT CS810 |
| CASSZ1791 30 mm SUITS ALL MODELS EXCEPT CS810 | |

OMERFLEXIGUN

OMer LP Tabber (Pneumatic)



FFPG Fletcher Framers Points Gun (Black) 07-500



Fletcher Framers Point Gun

Fires perfectly flat into frame. precision firing, no jamming or double feeding. Spring-adjusted firing power to match wood density. Easy to load magazine holds 100 points for reduced down time.



Used with Fletcher's Framers Points 08-950
FFMP Fletcher black gun (3000 framers points)

FFPGG Fletcher Flexi Points Gun (Green) 08-700



Fletcher Flexi Point Gun

Easy to load magazine accommodates 170 flexible points. Spring-adjusted firing power to match wood density. Lightweight and full-grip trigger provides comfortable firing of points.



Used with Fletcher's flexible points that can be easily bent to change frame contents. 08-955
FFLP Fletcher green gun (3700 framers points)

FFMG Fletcher Multi Master Gun (Yellow) 07-800



Fletcher Multi Master

Perfect for attaching multiple mouldings, stacked or liner, in the same frame. Easy to load magazine holds 167 MultiPoints per stack. Equipped with spring adjustment to adjust for wood density. Double-barbed design and wide body for increased holding strength.



Combined with screw hole, Multipoints provide secure fit between mouldings. Easy to bend for quick removal of glass, artwork and matboard

FMMP 08-975
Fletcher Yellow gun (3000 multi points)



LOGAN NAILS

Logan Dual Point Driver



Logan Dual - Drive Point Driver

Easy to load magazine accommodates either rigid or flexible points. Spring-adjusted firing power to match wood density. Lightweight and full-grip trigger provides comfortable firing of points.

Logan flexible point
2500 or 600 unit packs
Logan rigid point
2500 or 600 unit packs



LOGAN POINTS

| CODE | FLEXI POINTS | BOX QTY |
|-----------------|---------------------------------|---------|
| LOGAN FLEXI POS | LOGAN Flexible Point Small pack | 600 |
| LOGAN FLEXI POI | LOGAN Flexible Point Large pack | 2500 |
| LOGAN RIGID SM | LOGAN Rigid Point Small pack | 600 |
| LOGAN RIGID PO | LOGAN Rigid Point Large pack | 2500 |



T225 Hand Operated Tab Driver

The new T225 tab driver is the latest upgrade to one of the world's best selling Manual Tab drivers, with proven reliability at a great price.

- Magazine Feed
- Light Weight Yet Strong Build
- Ideal for Picture Framing or Window Glazing
- Works with any Backing Material
- Used by Hobby or Professional Framers
- Use Flexible or Rigid Tabs

FCT225 tab driver hand operated



This hand operated tool is used to insert flat tabs which neatly secure glass, artwork and backing board into a picture frame. Choose from either flexible or rigid tabs - the flexible tab can be bent up (just using a finger nail) so that the contents of the frame can be easily changed or taken out for cleaning. The rigid tabs are made from a stronger steel and can be used for a more permanent fixing.

Tabs are not included with the driver, please order separately.

Tab Size is 0.4mm x 4.3mm x 15mm

FCT4F flexible tabs for T220/T225/C306/C325 pack of 2500

FCT4R rigid tabs for T220/T225/C306/C325 pack of 2500



FPD01 Genesis Pneumatic Flexi Point Driver use with FP015 FTSTDISK



BRBM500 Pneumatic Vnail gun with a variety of uses in joining use LC7 v nails



FLETFLEXIBIG



Black colour points Flexi-master pneumatic (08-995c) 12,000 in a box



FLETFRAMERSBIG



Silver colour points Frame-master pneumatic(08-985) 12,000 in a box



FLETCHER POINTS

| CODE | POINTS | BOX QTY |
|------|--|---------|
| FMMP | FLETCHER Multi Master Points (For use in Yellow Gun) part 08-975 | 3000 |
| FFMP | FLETCHER Framers Points (For use in Black Gun) part 08-950 | 3000 |
| FFLP | FLETCHER Flexible Points (For use in Green Gun) part 08-955 | 3700 |
| FGPP | FLETCHER Glaziers points (For use in Black Gun) part 08-980 | 5000 |



Flexi Points

| | |
|----------|---|
| FP015 | Genesis 15mm Pneumatic Flexi Points 10,000 in a box. Box QTY 10 |
| FT25MMBK | Cassese 25mm Pneumatic Flexi Point |
| FTSTDISK | Cassese 15mm Pneumatic Flexi Point 15,000 in a box. Box QTY 10 |



FLETPNEFRAMEMA



Fletcher pneumatic Framemaster Gun (07-300)



FLETPNEFELEXIMA



Fletcher pneumatic Flexi Master Gun (07-400)



Staple Guns

With our range of quality Italian gun as well as our more affordable Swift guns we have your needs covered.

STP-8016



Airco Pneumatic Staple Gun 80-16 Made in Italy



STP97-19



Airco Pneumatic Staple Gun 97B-19 Made in Italy



STP400016



Airco Pneumatic Staple Gun 4000-19 Made in Italy



SWIFT97

Swift Pneumatic Staple Gun 97-25



SWIFT80

Swift Pneumatic Staple Gun 80-16



RAPID23GUN

The Rapid R23 is an extremely durable tacker for fine wire staples. Suitable for securing thin materials, such as fabrics, paper and labels, and other tasks that need only short staples. Made in Sweden, takes 13 series staples.



STS4000E

MAESTRI 4000 staple gun Made in Italy



STP80-16E

MAESTRI 8016 Electric Staple Gun Made in Italy



ARROWTACKER

Arrow T-Stapler



AMSSTP80L

AMS pneumatic staple Gun 80 gauge 3-16mm long nose



Oil Air Tool

Air tool for lubrication of pneumatic tools 236ML



Pin gun & pins

PGD01

Pin gun 12-25mm

FOR THE PERFECT JOIN



Automatic adjust for nail sizes, very quiet light weight minimise fatigue 0.6mm.

Headless pins is virtually invisible

PGP12S Headless Pins 12mm 10,000 per pack

PGP15S Headless Pins 15mm 10,000 per pack

PGP18 Headless Pins 18mm Box: 10,000 per pack

PGP20 Headless pins 20mm box: 10,000 per pack

PGP25S Headless Pins 25mm 10,000 per pack

Vnails

METAL TOP LOADER CARTRIDGE

Suits Taurus & Joyce and most Cassese Machines

These are made in the UK and are reusable metal cartridges to load your machines with

| CODE | DESCRIPTION | QTY |
|----------|-------------------|--------|
| JPWTL3.5 | 3.5 mm Top Loader | 1 Each |
| JPWTL5 | 5 mm Top Loader | 1 Each |
| JPWTL7 | 7 mm Top Loader | 1 Each |
| JPWTL10 | 10 mm Top Loader | 1 Each |
| JPWTL12 | 12 mm Top Loader | 1 Each |
| JPWTL15 | 15 mm Top Loader | 1 Each |



V NAILS SUITS: TAURUS, JOYCE, CASSESE, EURO, GIELLE, FRAMERS CORNERS, MORSO

These Vnails are made in the UK by Taurus and are of a very high quality

| CODE | DESCRIPTION | BOX QTY |
|---------|------------------------|---------|
| JPW3.5S | 3.5 mm Softwood V Nail | 10000 |
| JPW3.5H | 3.5 MM Hardwood V Nail | 10000 |
| JPW5S | 5 MM Softwood V Nail | 5000 |
| JPW5H | 5 MM Hardwood V Nail | 5000 |
| JPW7S | 7 MM Softwood V Nail | 5000 |
| JPW10HT | 10 MM Extra Hardwood | 5000 |
| JPW15S | 15 MM Softwood V Nail | 5000 |



VNAILS CASSESE

VNAILS SUITS: TAURUS, CASSESE, EURO, GIELLE, FRAMERS CORNERS, MORSO

| CODE | DESCRIPTION | BOX QTY |
|-------------|----------------------|---------|
| VNAILCAS7S | 7mm Softwood V Nail | 8000 |
| VNAILCAS7H | 7mm Hardwood V Nail | 8000 |
| VNAILCAS10S | 10mm Softwood V Nail | 8000 |
| VNAILCAS10H | 10mm Hardwood V Nail | 8000 |
| VNAILCAS12S | 12mm Softwood V Nail | 8000 |
| VNAILCAS12H | 12mm Softwood V Nail | 8000 |
| VNAILCAS15S | 15mm Softwood V Nail | 8000 |
| VNAILCAS15H | 15mm Hardwood V Nail | 8000 |



V NAILS SUITS: Alpha & Minigraf Machine, Brevetti

| CODE | DESCRIPTION | BOX QTY |
|-------|-----------------------|---------|
| MG5S | 5 MM Softwood V NAIL | 5000 |
| MG5H | 5MM Hardwood V NAIL | 5000 |
| MG7S | 7 MM Softwood V NAIL | 5000 |
| MG7H | 7 MM Hardwood V NAIL | 5000 |
| MG10S | 10 MM Softwood V NAIL | 3000 |
| MG12S | 12 MM Softwood V NAIL | 5000 |
| MG12S | 12 MM Softwood V NAIL | 2000 |
| MG12H | 12 MM Hardwood V NAIL | 5000 |
| MG12H | 12 MM Hardwood V NAIL | 2000 |
| MG15S | 15 MM Softwood V NAIL | 5000 |
| MG15S | 15 MM Softwood V NAIL | 2000 |
| MG15H | 15 MM Hardwood V NAIL | 5000 |



V NAILS SUITS: TAURUS, JOYCE, CASSESE, EURO, GIELLE, FRAMERS CORNERS, MORSO

These are value for money vnails that are of a good quality

| CODE | DESCRIPTION | BOX QTY |
|--------|-----------------------|---------|
| LC805 | 5 MM Softwood V Nail | 8,000 |
| LC805H | 5 MM Hardwood V Nail | 8,000 |
| LC807 | 7 MM Softwood V Nail | 8,000 |
| LC807H | 7 MM Hardwood V Nail | 8,000 |
| LC810 | 10 MM Softwood V Nail | 8,000 |
| LC810H | 10 MM Hardwood V Nail | 8,000 |
| LC812 | 12 MM Softwood V Nail | 8,000 |
| LC812H | 12 MM Hardwood V Nail | 8,000 |
| LC815 | 15 MM Softwood V Nail | 8,000 |
| LC815H | 15 MM Hardwood V Nail | 8,000 |



V NAILS SUITS: Alpha & Minigraf Machine & Brevetti Genesis

| CODE | DESCRIPTION | BOX QTY |
|--------|-----------------------|---------|
| LC705 | 5 MM Softwood V Nail | 8,000 |
| LC705H | 5 MM Hardwood V Nail | 8,000 |
| LC707 | 7 MM Softwood V Nail | 8,000 |
| LC707H | 7 MM Hardwood V Nail | 8,000 |
| LC710 | 10 MM Softwood V Nail | 8,000 |
| LC710H | 10 MM Hardwood V Nail | 8,000 |
| LC712 | 12 MM Softwood V Nail | 8,000 |
| LC712H | 12 MM Hardwood V Nail | 8,000 |
| LC715 | 15 MM Softwood V Nail | 8,000 |
| LC715H | 15 MM Hardwood V Nail | 8,000 |



V NAILS SUITS: Cartridge V-nails

| CODE | DESCRIPTION | QTY |
|--------|--|--------------|
| LC605 | 5 MM Softwood V Nail (White) | 5 Cartridges |
| LC605H | 5 MM Hardwood V Nail (White) | 5 Cartridges |
| LC607 | 7 MM Cartridge Softwood V Nail (Red) | 5 Cartridges |
| LC607H | 7 MM Cartridge Hardwood V Nail (Red) | 5 Cartridges |
| LC610 | 10 MM Cartridge Softwood V Nail (Orange) | 5 Cartridges |
| LC610H | 10 MM Cartridge Hardwood V Nail (Orange) | 5 Cartridges |
| LC612 | 12 MM Cartridge Softwood V Nail (Blue) | 5 Cartridges |
| LC612H | 12 MM Cartridge Hardwood V Nail (Blue) | 5 Cartridges |
| LC615 | 15 MM Cartridge Softwood V Nail (Yellow) | 5 Cartridges |
| LC615H | 15 MM Cartridge Hardwood V Nail (Yellow) | 5 Cartridges |



for CASSESE only

Vnails CASSESE Cartridges

for cassese only

| CODE | DESCRIPTION OF STAPLE | Qty |
|----------------|-------------------------------------|---------------|
| VNAIL CASCR7H | 7mm Hardwood Cartridge (Pink) | 40 cartridges |
| VNAIL CASCR10H | 10mm Hardwood Cartridge (Baby blue) | 40 cartridges |
| VNAIL CASCR12H | 12mm Hardwood Cartridge (blue) | 40 cartridges |
| VNAIL CASCR15H | 15mm Hardwood Cartridge (White) | 40 cartridges |



Cassese Alpha & Minigraf Vnails



| CODE | DESCRIPTION |
|--------------|---------------------|
| VNAIL CMG7H | 7mm hardwood vnail |
| VNAIL CMG7S | 7mm softwood vnail |
| VNAIL CMG10H | 10mm hardwood vnail |
| VNAIL CMG10S | 10mm softwood vnail |
| VNAIL CMG12H | 12mm hardwood vnail |
| VNAIL CMG12S | 12mm softwood vnail |
| VNAIL CMG15H | 15mm hardwood vnail |
| VNAIL CMG15S | 15mm softwood vnail |

8,000 per box



Staples

| CODE | DESCRIPTION OF STAPLE | Box Qty |
|---------|---|---------|
| STS803 | galvanized fine wire staples for use with 80 series 3mm high | 10000 |
| STS804 | galvanized fine wire staples for use with 80 series 4mm high | 10000 |
| STS806 | galvanized fine wire staples for use with 80 series 6mm high | 10000 |
| STS808 | galvanized fine wire staples for use with 80 series 8mm high | 10000 |
| STS810 | galvanized fine wire staples for use with 80 series 10mm high | 10000 |
| STS812 | galvanized fine wire staples for use with 80 series 12mm high | 10000 |
| STS814 | galvanized fine wire staples for use with 80 series 14mm high | 10000 |
| STS816 | galvanized fine wire staples for use with 80 series 16mm high | 10000 |
| STS976 | galvanized fine wire staples for use with 97 series 6mm high | 10000 |
| STS978 | galvanized fine wire staples for use with 97 series 8mm high | 5000 |
| STS9710 | galvanized fine wire staples for use with 97 series 10mm high | 5000 |
| STS9712 | galvanized fine wire staples for use with 97 series 12mm high | 5000 |
| STS9714 | galvanized fine wire staples for use with 97 series 14mm high | 5000 |
| STS9716 | galvanized fine wire staples for use with 97 series 16mm high | 5000 |
| STS9719 | galvanized fine wire staples for use with 97 series 19mm high | 5000 |
| STS9725 | galvanized fine wire staples for use with 97 series 25mm high | 5000 |
| STS4008 | galvanized fine wire staples for use with 4000 series 8mm high | 5000 |
| STS4010 | galvanized fine wire staples for use with 4000 series 10mm high | 5000 |
| STS4012 | galvanized fine wire staples for use with 4000 series 12mm high | 5000 |
| STS4014 | galvanized fine wire staples for use with 4000 series 14mm high | 5000 |
| STS4016 | galvanized fine wire staples for use with 4000 series 16mm high | 5000 |

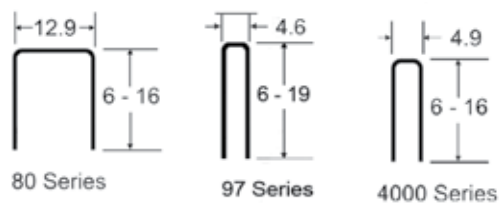

STAINLESS STEEL STAPLES STS806SS

Airco high quality stainless steel staples grade 316 are great where corrosion can occur. Box Qty 10,000

| | | |
|-----------|--|-------|
| STS1306SS | Rapid 13 series Stainless Steel 6mm | 2500 |
| STS1304 | Rapid 13 series Galvanized Staples 4mm | 5000 |
| STS1310 | Rapid 13 series Galvanized Staples 10mm | 5000 |
| STS4415 | galvanized fine wire staples for use G4450 gun 15mm high | 5000 |
| STS6018 | galvanized fine wire staples for use 6000-25 gun 18mm high | 5000 |
| STS6030 | galvanized fine wire staples for use 6000-25 gun 30mm high | 5000 |
| STS7106 | galvanized fine wire staples for use 71/16 gun 6mm high | 10000 |
| STS7108 | galvanized fine wire staples for use 71/16 gun 8mm high | 10000 |

Preservation Clear 99™

Preservation Clear 99™ provides UV protection by blocking out 99% of harmful rays thus helping prevent the treasured keepsake from fading. Preservation Clear 99™ is your great choice for picture framing!

This Artglass™ Product Has The Following Features And Benefits:

- CRISP IMAGE RESOLUTION
- NO "ORANGE PEEL" SURFACE DISTORTION
- 20% LIGHTER THAN SIMILAR PRODUCTS
- 99% UV PROTECTION
- NEUTRAL COLOR FROM ALL ANGLES
- HELPS PREVENT FADING

Meets ISO 189025 standard

Meets conservation standards of FATG and PPFA

| code & description | m2 per pack | sheets per pack |
|---------------------------------------|-------------|-----------------|
| PCUV914/12192 PC99 36"X48" | 3.10m2 | 2 |
| PCUV1016/15242 PC99 1016mm x1524mm | 4.46m2 | 4 |

Technical Information

| Reflection | Transmission | UV-protection | Thickness, mm |
|------------|--------------|---------------|---------------|
| <8% | >89% | >99% | 2 |



Artglass WW™

Artglass WW™ reveals true colors and texture of the art – no green tint or optical distortions. Thanks to its anti-reflective coating, which reduces unwanted reflections to less than 1%, nothing will prevent one from viewing the actual content of the framed item. Moreover Artglass WW™ has a smooth surface that allows for details to emerge unaltered. Artglass WW™ will enlighten the work of every framer – it can be cut and glazed from either side and its coating is scratch resistant and very easy to clean.



This Artglass™ Product Has The Following Features And Benefits:

- NO REFLECTION
- IMPROVED TRANSMISSION
- EASY TO CLEAN AND ABRASION RESISTANT
- NEUTRAL COLORS IN REFLECTION AND NO COLOR SHIFT UNDER AN ANGLE
- EASY TO PROCESS TO YOUR SPECIFICATIONS
- HIGH DURABILITY AND LONG LIFETIME OF THE COATING

Technical Information

| Reflection | Transmission | UV-protection | Thickness, mm |
|------------|--------------|---------------|---------------|
| <1% | >99% | >70% | 2 |

- big sheets are available, while most popular are the cut-sizes, 1100x1600mm; 1200x1600mm

- UV protection is calculated as an average UV light blocking capability in 280-380 nm spectral region.

| code & description | m2 per pack | sheets per pack |
|--|-------------|-----------------|
| AGWW914/12192 AR72 36"x48" | 2.23m2 | 2 |
| AGWW1100/16002 AR72 1100mm x 1600mm | 3.52m2 | 2 |
| AGWW1100/16003 AR72 1100mm x 1600mm | 5.28m2 | 3 |
| AGWW1200/16002 AR72 1200x 1600mm | 3.84m2 | 2 |

Artglass UV WW™

Choose Artglass UV WW™ to achieve an outstanding clarity with its capability to transmit ~98% of light and to gain a conservation grade UV protection* of >90%. Artglass UV WW™ will make you forget about green tint and optical distortion. Moreover, the anti-reflective coating reduces unwanted reflections to less than 1%, in the meantime it is scratch resistant and very easy to clean. It can be cut and glazed from either side.



This Artglass™ Product Has The Following Features And Benefits:

- NO REFLECTION
- IMPROVED TRANSMISSION
- EASY TO CLEAN AND SCRATCH-RESISTANT
- NEUTRAL COLORS IN REFLECTION AND NO COLOR SHIFT UNDER AN ANGLE
- EASY TO PROCESS TO YOUR SPECIFICATIONS
- HIGH DURABILITY AND LONG LIFETIME OF THE COATING

Technical Information

| Reflection | Transmission | UV-protection | Thickness, mm |
|------------|--------------|---------------|---------------|
| <1% | >98% | >90% | 2-3 |

- big sheets are available, while most popular are the cut-sizes 1100x1600mm; 1200x1600mm

- UV protection is calculated as an average UV light blocking capability in 280-380 nm spectral region.

| code & description | m2 per pack | sheets per pack |
|--|-------------|-----------------|
| AGUV1100/16002 AR92 1100mm x 1600mm | 3.52m2 | 2 |
| AGUV1200/16002 AR92 1100mm x 1600mm | 3.84m2 | 2 |

Artglass UV 99™

Artglass UV 99™ is the highest performance anti-reflective glass with 99% UV protection. The “invisible” glass ensures neutral reflection color and helps prevent the treasured keepsake from fading. Artglass UV 99™ is your perfect choice for picture framing!



This Artglass™ Product Has The Following Features And Benefits:

- LESS THAN 1% LIGHT REFLECTION
- CRISP IMAGE RESOLUTION
- NO “ORANGE PEEL” SURFACE DISTORTION
- 20% LIGHTER THAN SIMILAR PRODUCTS
- 99% UV PROTECTION
- NEUTRAL COLOR FROM ALL ANGLES
- HELPS PREVENT FADING
- MEETS ISO 18902 STANDARD



| code & description | m2 per pack | sheets per pack |
|--|-------------|-----------------|
| AGUV914/12192 AR99 36"x48" | 2.23m2 | 2 |
| AGUV991016/15242 AR99 40"x60" | 3.10m2 | 2 |
| AGUV991200/1600 AR99 1200mm x1600mm | 3.84m2 | 2 |

Technical Information

| Reflection | Transmission | UV-protection | Thickness, mm |
|------------|--------------|---------------|---------------|
| <1% | >97% | >99% | 2 |

Clear Float or Sheet Glass

Our 2mm thick glass is available in both sheet & float glass. Glass can be sent out Australia wide provided you purchase in case lots. Loose quantity mirrors can be picked up from our Brunswick branch.



Best quality 2mm glass in the world, double washed glass so you receive it ready for use requiring minimal cleaning and high opacity. All glass is interleaved with paper for protection no powder is used. Prices are for full cases to most capital cities. Other areas need to allow for additional freight. If the size you are looking for is not listed, please call us as we can cut to size.

Fully stocked warehouses all over Australia!*

Bevelled Mirrors

The quality of our bevelled mirrors is of a very high standard. They are 4mm thick & silver backed mirror with a polished 25mm bevelling. These mirrors can be sent out Australia wide provided you purchase in case lots. Loose quantity mirrors can be picked up from our Brunswick branch. These are the Melbourne Metro prices and Nett prices.

Available Sizes

| Size |
|-----------|
| 18" x 24" |
| 20" x 24" |
| 23" x 35" |

| Size |
|-----------|
| 24" x 30" |
| 24" x 36" |
| 36" x 48" |

If the size you are looking for is not listed, please call us as we are receiving more stock all the time.

Plain Mirrors

Our quality 3mm mirrors are silver backed and can be cut to many sizes. The mirrors can be shipped out Australia wide, provided you purchase in case lots. Loose quantity mirrors can be picked up from our Brunswick branch. These are the Melbourne Metro prices and Nett prices.

Available Sizes

| Size |
|--------------|
| 12" x 24" |
| 18" x 36" |
| 24" x 36" |
| 36" x 48" |
| 360 x 1200mm |

| Size |
|---------------|
| 400 x 1350mm |
| 750 x 1830mm |
| 915 x 1220mm |
| 1525 x 1830mm |
| 1830 x 1220mm |

If the size you are looking for is not listed, please call us as we can cut to size.

Non Reflective Glass

Lightly Etched quality 2mm glass causes the light to disperse and minimize reflection. Glass can be sent out Australia wide provided you purchase in case lots. Loose quantity mirrors can be picked up from our Brunswick branch. These are the Melbourne Metro prices and Nett prices. It is washed and paper interleaved, very clear and very clean. Needs minimal cleaning.

Available Sizes

| Size |
|---------------|
| 36" x 48" |
| 1220 x 1840mm |

Prices are subject to 10% GST.

* excluding QLD

everyday accessories

Available Sizes

| Size | Sheets Per Case |
|-----------------|-----------------|
| 7" x 18" | 2460 |
| 8" x 10" | 3875 |
| 8" x 12" | 3229 |
| 8" x 16" | 2405 |
| 8" x 20" | 1937 |
| 8" x 24" | 1614 |
| 10" x 13" | 2384 |
| 10" x 20" | 1550 |
| 10" x 24" | 1291 |
| 10" x 30" | 1033 |
| 11" x 14" | 2012 |
| 12" x 16" | 1615 |
| 14" x 18" | 1230 |
| 16" x 16" | 1210 |
| 16" x 20" | 969 |
| 16" x 24" | 802 |
| 18" x 24" | 717 |
| 20" x 24" | 645 |
| 20" x 30" | 516 |
| 20" x 60" | 258 |
| 22" x 28" | 503 |
| 24" x 36" | 358 |
| 24" x 48" | 269 |
| 24" x 60" | 215 |
| 32" x 36" | 269 |
| 32" x 40" | 242 |
| 36 x 48" 1/2 | 89 |
| 36" x 48" Large | 179 |
| 42" x 54" | 136 |
| A3 297 x 420mm | 1603 |
| A4 297 x 210mm | 3206 |
| 300 x 915mm | 728 |
| 360 x 281mm | 1977 |
| 390 x 508mm | 1099 |
| 400 x 600mm | 834 |
| 420 x 594mm | 801 |
| 480 x 680mm | 612 |
| 495 x 695mm | 581 |
| 500 x 700mm | 571 |
| 500 x 900mm | 444 |

| Size | Sheets Per Case |
|-------------------|-----------------|
| 500 x 1000mm | 400 |
| 585 x 800mm | 427 |
| 594 x 840mm | 400 |
| 600 x 600mm | 555 |
| 600 x 800mm | 416 |
| 600 x 900mm | 370 |
| 600 x 1000mm | 333 |
| 610 x 760mm | 435 |
| 640 x 800mm | 390 |
| 670 x 1170mm | 255 |
| 680 x 680mm | 432 |
| 685 x 685mm | 426 |
| 700 x 700mm | 408 |
| 700 x 1000mm | 285 |
| 700 x 1830mm | 156 |
| 720 x 1525mm | 182 |
| 740 x 840mm | 321 |
| 740 x 870mm | 310 |
| 760 x 1120mm | 239 |
| 780 x 980mm | 261 |
| 800 x 800mm | 312 |
| 800 x 1000mm | 250 |
| 813 x 813mm | 302 |
| 820 x 1110mm | 234 |
| 900 x 700mm | 317 |
| 914 x 1300mm | 179 |
| 914 x 1400mm | 156 |
| 915 x 915mm | 238 |
| 915 x 1525mm | 143 |
| 915 x 1700mm | 130 |
| 920 x 1525mm | 142 |
| 1000 x 1000mm | 200 |
| 1100 x 800mm | 227 |
| 1120 x 1120mm | 159 |
| 1220 x 1220mm | 134 |
| 1525 x 1220mm | 107 |
| 1525 x 1220mm 1/2 | 58 |
| 1830 x 1220mm | 89 |
| 1830 x 1220mm 1/2 | 45 |

R

Rising®

LEGION PAPER
Fine Art Papers



THE ART OF PRESERVATION

Rising Museum Boards. The most trusted brand of Museum Boards – Worldwide.
100% Cotton, Acid-Free, Archival, Tree-Free.

MATBOARD

R

Rising



Superior Standards

Rising Museum boards are made with 100% cotton and sets the industry standard that others attempt to meet.

It not only meet, but exceeds the standards set by the Fine Art Trade Guild and the Library of Congress.

Did you know?

Rising is used in the following museums

- The Metropolitan Museum of Art
- Museum of Modern Art
- Solomon R Guggenheim Museum
- The National Gallery
- The Library of Congress
- The Smithsonian Institution
- Museum of Fine Art, Boston
- Isabella Stuart Gardner Museum
- The J. Paul Getty Museum
- Norton Simon Museum
- Los Angeles County Museum Art

The Preservation Qualities of Rising

Your fine art deserves the highest quality matting and mounting materials made today, and so do your customers. The unique methods of manufacturing, content purity and quality make Rising Conservation and Museum Board the ideal choice for lasting performance.

100% Cotton

Cotton is naturally lignin-free. One hundred percent rag is used to produce all Rising Museum Board. The result is a board that provides matchless quality and extraordinary preservation characteristics. Rag papers have survived the test of time.

Acid-Free

Rising Board is made with a minimum pH of 7 and is acid-free. No alum is used in the entire papermaking process.

Adhesive

The single ply sheets are laminated together using an inert adhesive that is 100% acid-free and archival.

Buffering

All Rising boards are buffered with a minimum 3% calcium carbonate (except the Photomount papers, which have no calcium carbonate buffering) as required by the U.S. Library of Congress to protect the board from hostile environmental factors.

Eco-Friendly

The cotton used to manufacture Rising Museum Boards is not from the puffy white flower that we all recognize as cotton, but rather the linters, or byproduct, from the textile industry. Textiles are made using the longest, highest-quality fibers – the rest is discarded. This wasted cotton is salvaged and used to manufacture Rising Museum Boards. Nothing could be more eco-friendly than reusing a product that is considered waste – otherwise this would all end up in the trash.

Pigments

Only the finest pigments are used in the manufacturing process to ensure that all the colours will not bleed, rub off or fade.* The light-fast colours are solid throughout and are fixed into the fiber. Each run of Rising Museum Board is matched to a stored colour sample and controlled using computerized colour measurement and trained colour technicians.

Rigid Quality Control & Consistency

Rising Museum Board is continuously tested during the manufacturing process by both computer and manual controls to ensure conformance to the TAPPI and ASTM specifications required by the archival community.

Superior Cutting

No other board cuts as precisely as Rising to produce an ultra-sharp and clean bevel. To ensure this quality all plies are from the same quality and caliper with consistent density throughout. Rising Museum Boards have been touted by museum and framing galleries worldwide as the best cutting board in the market.

*Due to the use of carbon black dies used to manufacture the Black Rising Museum Boards, there will be some minor scuffing.

As the demand for matting and framing of larger pieces of quality artwork increases framers are finding that they need larger shops. Rising has responded to this demand by expanding the range of products available in its Rising Museum Board line, including oversized, 100 percent cotton finer boards.

Rising Museum Board, which is acid-free, available in a focused colour palette and meets quality standards exceeding those set by the Library of Congress and the Fine Art Trade Guild in the United Kingdom, is now available in both 48" x 72" and 60" x 104" sizes in shades of white and warm white. These new oversized Rising boards come in both 4 ply and 8ply varieties and ship in their own strapped, protected master carton containing 10 sheets each.

The most significant advantage of Rising over any other cotton board are its clean-cutting quality and consistency. If a framer is matting with an 8-ply board, they want the bevel cut to be clean, without any fraying. Framers using Rising reply on this feature. These boards are also clean. If you're framing a piece of art, the one thing that can ruin the mat is a small speck or dent on the surface Rising Museum Boards are speck and dirt free.

Rising paper is currently the only company offering 60"x104" oversized, 100-percent cotton museum boards, which allow framers greater capabilities to work with larger pieces of artwork.

Available Sizes:

32x40 40x60 48x72 48x96 60x104

R
Rising®

The world's
largest
100% Cotton
Museum Board
60" x 104"
In Solid Black

new

Rising Museum Board

| Product Code | Description | Sheets per box |
|--------------|---------------------------|----------------|
| RMB 405601 | Antique White 32x40 2ply | 50 |
| RMB 405602 | Antique White 32x40 4ply | 25 |
| RMB 401720 | Antique White 32X40 8ply | 20 |
| RMB 405603 | Antique White 40X60 4ply | 25 |
| RMB 401721 | Antique White 40X60 8ply | 10 |
| RMB 401722 | Antique White 60x104 4ply | 10 |
| RMB 405630 | Black 32X40 2ply | 50 |
| RMB 405820 | Black 32X40 4ply | 25 |
| RMB 405819 | Black 32X40 8ply | 20 |
| RMB 405821 | Black 40X60 4ply | 25 |
| RMB 405822 | Black 40X60 8ply | 10 |
| RMB 402875 | Black 48x72 4ply | 25 |
| RMB 402874 | Black 60x104 4 ply | 10 |
| RMB 400906 | Cream 32X40 4ply | 25 |
| RMB 400908 | Cream 40X60 4ply | 25 |
| RMB 405454 | Fawn 32X40 4ply | 25 |
| RMB 405420 | Ivory 32X40 4ply | 25 |
| RMB 405421 | Ivory 40x60 4ply | 25 |
| RMB 405460 | Light gray 32x40 4ply | 25 |
| RMB 401951 | Medium Grey 32 x 40 2ply | 50 |
| RMB 405620 | Medium Grey 32 x 40 4ply | 25 |
| RMB 401953 | Natural 32x40 2 ply | 50 |
| RMB 401956 | Natural 32X40 4ply | 25 |
| RMB 401730 | Natural 32X40 8ply | 20 |
| RMB 402487 | Natural 40X60 4ply | 25 |
| RMB 401731 | Natural 40X60 8ply | 10 |
| RMB 405730 | Neutral Grey 32x40 4ply | 25 |
| RMB 405731 | Neutral Grey 40X60 4ply | 25 |
| RMB 405720 | Olde White 32X40 4ply | 25 |
| RMB 405721 | Olde White 40x60 4ply | 25 |
| RMB 405901 | Polar White 32 x 40 2 ply | 50 |
| RMB 405902 | Polar White 32 x 40 4ply | 25 |
| RMB 405904 | Polar White 32x40 8ply | 20 |
| RMB 405903 | Polar White 40X60 4ply | 25 |
| RMB 405905 | Polar White 40x60 8 ply | 10 |
| RMB 405907 | Polar White 60x104 4 ply | 10 |
| RMB 403196 | Warm White 40X60 4ply | 25 |
| RMB 403198 | Warm White 32x40 2 ply | 50 |
| RMB 402447 | Warm White 32X40 4ply | 25 |
| RMB 401710 | Warm White 32X40 8ply | 20 |
| RMB 401820 | Warm White 48X 72 4ply | 20 |
| RMB 401825 | Warm White 48x 72 8ply | 10 |
| RMB 401805 | Warm White 48X96 4ply | 10 |
| RMB MUS4WW60 | Warm White 60 X 104 4ply | 10 |
| RMB 401711 | Warm White40X60 8ply | 10 |
| RMB 402873 | White 60 X 104 - 4ply | 10 |
| RMB 401144 | White 32x40 1ply | 200 |
| RMB 401952 | White 32x40 2ply | 50 |
| RMB 402872 | White 32X40 4ply | 25 |
| RMB 401700 | White 32X40 8ply | 20 |
| RMB 401755 | White 40x60 2ply | 25 |
| RMB 402490 | White 40X60 4ply | 25 |
| RMB 401701 | White 40X60 8ply | 10 |
| RMB 401810 | White 48 X 72 4ply | 20 |
| RMB 401815 | White 48 X 72 8ply | 10 |
| RMB 401705 | White 48x96 4 ply | 10 |
| RMB 400975 | Zinc 32X40 4ply | 25 |
| RMB 400974 | Zinc 40X60 4ply | 25 |



NEW! Rising Conservation Core

Rising Conservation Board combines the permanence of our Rising Museum Board with the affordability of a wood pulp board. These acid and lignin-free boards are suitable for both fine art and photographic pieces. Rising Conservation Board is relatively inexpensive and designed for extended longevity.

Rising cuts the cleanest bevels with no feathering or blade drag; the surface is level with a slight vellum surface (not smooth) so as not to compete with artwork being matted and framed.

The surface is not hard or very smooth making it an excellent choice for all drawing techniques. Fine stationers and invitation converters also find the board quite suitable for letterpress engraving ect

Rising Conservation Board

| Product Code | Description | Sheets per box |
|--------------|-----------------------|----------------|
| RCB 403026 | White 32X40 4ply | 25 |
| RCB 403028 | White 40X60 4ply | 25 |
| RCB 403124 | Snow White 40x60 8ply | 10 |
| RCB 403126 | Snow White 32x40 4ply | 25 |
| RCB 403128 | Snow White 40x60 4ply | 25 |
| RCB 403129 | Snow White 32x40 8ply | 25 |

NEW CONSERVATION MATBOARD

Duo Conservation Board is white on one side & off white on the other it is certified "FSC MIXED" & PAT tested. FATG Conservation standard. It is tested extensively on it also exceeds CMCs with outstanding matcutter success can be used as matboard, barrier board & backing board. sizes 4ply 1220mm x1220mm or 1220mm x1600mm



code
DUO410612X12
DUO410612X16



ColourMount

SLATER HARRISON
Inspirational paper and board since 1929

MATBOARD

| | | | | | | |
|----------------------|-----------------------|---------------------|-------------------------|------------------------|---------------------------|------------------------|
| 300 PEARL ▲J | 301 IVORY ◆J | 302 CREAM | 303 BUFF | 304 SAND ● | 305 BLOSSOM | 306 WARM IVORY |
| 307 CHAMPAGNE | 308 OYSTER | 309 OLD IVORY | 310 BEIGE J | 311 COFFEE ● | 313 CHOCOLATE ● | 314 SEPIA ● |
| 315 SEAL BROWN ●J | 321 PORTLAND J | 322 DOVE GREY | 323 STONE | 324 SMOKE GREY ● | 325 CHARCOAL ●J | 326 SCHOOL GREY ● |
| 328 GRANITE ● | 329 PASTEL GREEN | 330 SAGE GREEN ● | 331 MOORLAND GREEN ● | 332 BOTTLE GREEN ●J | 333 HOLLY GREEN ● | 334 MAPLE ● |
| 335 LAUREL | 339 MIDNIGHT ● | 340 BLUEBELL | 341 SLATE | 342 COBALT BLUE ● | 343 OXFORD BLUE ●J | 344 PASTEL BLUE |
| 345 CLOUD | 346 LUPIN | 347 PORCELAIN | 349 BEAUJOLAIS ● | 350 ROUGE ● | 351 POPPY ● | 353 BURGUNDY ● |
| 355 DUSTY PINK ● | 356 PASTEL PINK | 359 HAZELNUT | 371 WHITE T▲J | 372 BLACK ●T▲◆J | 375 SOFT WHITE ▲◆J | 377 DAWN MIST ▲ |
| 382 SUGARED ALMOND | 385 ICED CRYSTAL | 389 ARCTIC WHITE | 390 GRAPE ● | 391 SIMPLY WHITE | 3001 CHALK WHITE ▲J | 3002 POLAR WHITE ▲ |
| 3003 BUTTERMILK | 3004 ALMOND | 3007 BAMBOO | 3015 VANILLA | 3023 MUSHROOM | 3030 LEAF GREEN ● | 3031 FOREST GREEN ● |
| 3040 CHINA RED ● | 3916 SPICE BROWN ● | 3917 ESSENCE WHITE | 3920 HARVEST BEIGE | 3925 SANDSTONE | 3931 CHIVE ● | 3945 PIGEON ● |
| 3951 CLEAR WATER | 3954 NIGHTSHADE ● | 3965 HAYSTACK | 3971 SNOW WHITE | 3973 ICED WHITE ▲J | 3975 ANTIQUE WHITE ▲◆J | 3981 OFF WHITE ▲J |

CONSERVATION

Mountboard;purified wood feibre,free from acid

www.fineart.co.uk ©FATG 2011 Licence: MBC070



CONSERVATION

WHITE CORE

Thickness:1.4mm Size:815X1200mm

Colours marked with ● are standard white core.Colours available in Jumbo size, 2mm,and Deep Bevel are indicated.See KEY

| KEY | |
|-----|------------------------|
| ● | White Core |
| T | Deep Bevel Tape |
| ▲ | 2mm Board |
| ◆ | 3mm Board |
| J | Jumbo-White Core 1.4mm |

| | | | | | | |
|--|---|---|------------------|-----------------------|--------------------|-------------------|
| | | | | | | |
| 3982 HONEYSUCKLE | 3983 PUTTY | 3984 CAMEO | 3985 SAND INGRES | 3986 CREAM INGRES | 3987 WHITE INGRES | 3989 BARLEY |
| | | | | | | |
| 3990 SHAMROCK | 3991 EMERALD ● | 3992 LIME ● | 3993 AQUA ● | 3994 SKY ● | 3995 LEMON ● | 3996 TANGERINE ● |
| | | | | | | |
| 3997 GERANIUM ● | 3998 CINDER GREY ● | 3999 EBONY ● | 3501 UNICORN ● | 3506 OR ● | 3507 FALCON ● | 3701 EGGSHELL ● |
| | | | | | | |
| 3710 SILVER BIRCH | 3715 LOGANBERRY ● | 3720 CHESTNUT ● | 3725 OSPREY | | | |
| LUSTRE White Core Thickness:1.4mm Size:815X1200mm | | | | | | |
| | LU01 LILY WHITE ● | LU04 PALE IVORY ● | LU05 SCARLET ● | LU06 EMERALD LUSTRE ● | LU08 JET BLACK ● | |
| CENTURAMETALLIC White Core Thickness:1.4mm Size:815X1200mm | | | | | | |
| | 361 SILVER ● | 362 GOLD ● | 364 OLD GOLD ● T | CM11 WHITE GOLD ● | CM12 PALE SILVER ● | CM13 GREEN GOLD ● |
| | | | | | | |
| CM14 PALE GOLD ● | CM15 SOLAR GOLD ● | CM16 ROSE GOLD ● | CM17 COPPER ● | CM18 BRONZE ● | CM19 PLATINUM ● | |
| BLACK CORE Thickness:1.25mm Size:815X1125mm | | | | | | |
| | 401 GUELDER ROSE | 405 OSPREY | 407 CELANDINE | 411 CHALK WHITE | 412 POLAR WHITE | 415 SEAL BROWN |
| | | | | | | |
| 417 BAMBOO | 423 MUSHROOM | 425 CHARCOAL | 431 FOREST GREEN | 440 CHINA RED | 442 COBALT BLUE | 449 BEAUJOLAIS |
| | | | | | | |
| 471 WHITE | 472 SOLID BLACK | 485 SAND INGRES | 486 CREAM INGRES | 487 WHITE INGRES | 491 SIMPLY WHITE | |
| MONOCHROME MOUNTBOARD Size:815X1200mm Packed in 5's | | | | | | |
| | BLACK/WHITE/BLACK 3.4mm Ref.MC34B 2.8mm Ref.MC28B | WHITE/BLACK/WHITE 3.4mm Ref.MC34W 2.3mm Ref.MC23W | | | | |

MATBOARD

Specialty Matboard Corp.

The complete source for solid and designer matboard

Tolerance for all matboards can be +/- 1/8".
White Core items are acid free, lignin free with a greater than 85% alpha cellulose core.

12 NEW ADDITIONS



681 Peppered Gray
W



682 Peppered Cream
W



683 Peppered Taupe
W

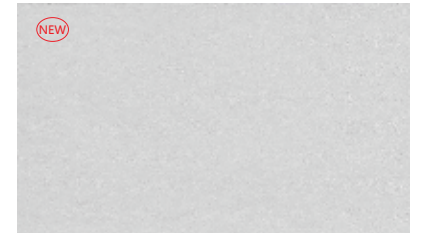

684 Cape Cod
W



685 Pewter
W



686 Shadow
W

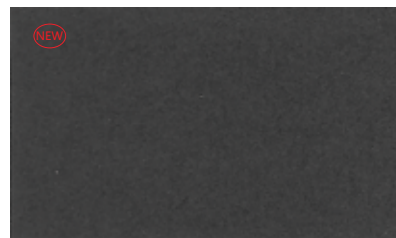

687 Graphite
W



688 Marine
W



689 Lavender
W



690 Emerald
W



691 Kiwi
W



692 Pink
W



328 Polar White
W - X - DW - WXL - W44



677 Angora
W - X



672 Tissue White
W - B - X



900 Snowdrift
W - X



669 Frosty White
W - X



671 Blizzard White
W - B - X - BX - WXL

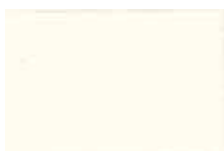

673 Artist White
W - X



678 Alabaster
W - X



450 Topsail White
W - X



460 Portrait White
W - X



275 Warm White
W - X



305 Porcelain
W - B



674 Cotton
W - X



472 Off White
W



281 Ivory
W



079 Eggshell
W - X



279 Canary Fluff
W



475 Soft Butter
W



659 Rich Butter
W - X



090 Sunflower
W - X

W = White Core
32 x 40
B = Black Core
32 x 40
X = Oversize
40 x 60
DW = Double
Thick White Core
DB = Double
Thick Black Core
BX = Black Core
Oversize 40 x 60
W44 = White Core
32 x 44
WXL = White Core
40 x 72
AS = Conservation
(Alpha Core)



680 Gold Rush
W



306 Egg Creme
W-X



316 Latte
W-X



401 Sand
W-X



519 Desert Sand
W-X



278 Caramel
W



487 Rattan
W



419 Champagne
W



318 Tuscany
W



654 Ginger Cookie
W-X



319 Burnt Topaz
W



658 Sweet Potato
W-X



440 Pumpkin
W



665 Autumn Orange
W-X



667 Lime Twist
W



663 Sour Apple
W



650 Safari Green
W-X



317 Rosemary
W-X



664 Oak Leaf
W



422 Bayberry
W



062 Clover
W



283 Cypress
W



015 Zucchini
W



418 Concord Green
W-X



652 Summer Green
W-X



314 Polo Green
W



655 Sea Mist
W-X



309 Fiesta Blue
W



676 Coastal Blue
W



666 Misty Blue
W



473 Caribbean Blue
W



019 Soft Blue
W



429 Electric Blue
W



675 Banner Blue
W



020 Nautica
W



260 French Blue
W



280 Pacific Blue
W



001 Navy
W-X



312 Purple
W



668 Hot Pink
W



679 Cherry Red
W



656 Holiday Red
W-X

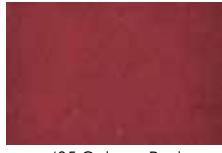

435 Calvary Red
W



022 Ruby
W



284 Red Rock
W-X



282 Scarlet
W-X



056 Sienna
W



006 Merlot
W-X



441 Terracotta
W



651 Molten Lava
W-X



60490 Rubbed Silver
W

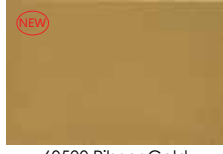

NEW

60500 Pilsner Gold
W



60311 Satin
W



078 Autumn Gray
W



518 Tumbleweed
W-X

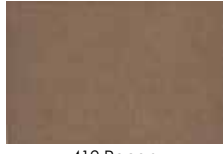

412 Pecan
W-X



047 Hopi Tan
W

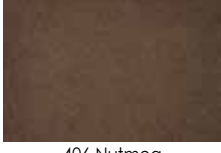

406 Nutmeg
W

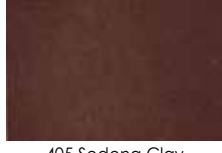

405 Sedona Clay
W



277 Chestnut
W-X



045 Fudge
W



653 Acorn
W-X



080 Brownie
W-X



409 Basic Brown
W-X

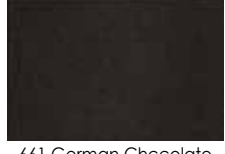

661 German Chccolate
W-X

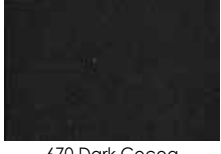

670 Dark Cocoa
W

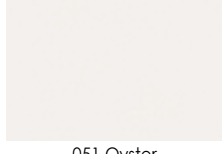

051 Oyster
W-X



462 Oxford Gray
W



014 Sterling Gray
W



456 TV Gray
W

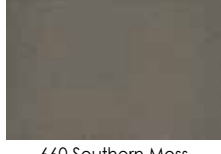

660 Southern Moss
W

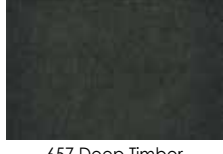

657 Deep Timber
W-X



057 Charcoal
W



411 Espresso
W-X



459 Salem Black
W



414 Tru Black
W-B-X-DB-WXL-W44



DC674 Cotton
8 Ply



DW328 Polar White
8 Ply

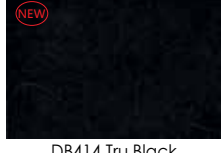

NEW

DB414 Tru Black
8 Ply



NEW

AS900 Conservation White
Conservation

MATBOARD

MATBOARD

Gallery Line



58080 Doe Skin
W



58700 Aperture
W



58702 Perspective
W



58751 Botticelli
W



58752 Donatello
W



58753 Michelangelo
W

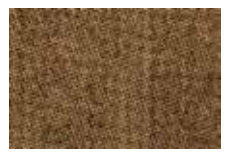

58754 Palazzo
W



58755 Giotto
W



58756 Raphael
W



58757 Sandro
W



58872 Bristol
W



58873 Devon
W



58931 Southdown
W



58932 Lasso
W



58933 Poncho
W



58934 Chaps
W



58935 Bridle
W



W58900 Faux Gray Suede



W58901 Faux Sunflower Suede



W58902 Faux Holiday Suede



W58903 Faux Ruby Suede



W58904 Faux Sienna Suede



W58905 Faux Concord Suede



W58906 Faux Coastal Suede



W58907 Faux Purple Suede



W58908 Faux Nautica Suede



W58909 Faux Cherry Suede



W58910 Faux Navy Suede



W58911 Faux Salem Suede



W58912 Faux Pumpkin Suede



58865 Brighton
W



58868 Coventry



58881 Leeds



58875 York



58880 Manchester



58879 Blackpool
W



58701 Exposure
W



58703 Focus
W



58082 Fallow



58083 Brownsugar



58322 Moleskin



58323 Quicksand



58324 Mudpuddle



58326 Settingsun



58332 Adobe



58333 Weepingwillow



58334 Poppyseed



58360 Sourdough



58364 Candlewick



58365 Derby



58366 GreenApple



58367 Gingersnap



58374 Cranapple



58375 PicanteRed



58379 Wooddchuck



58440 BlackNight



58449 DarkCamel



58456 Summer Leaf



58464 BiscayneBlue



58475 Seagull



58476 BarHarbor



58477 GroveOak



58478 CornHusk



58479 Turtledove



58747 Dante



58745 32x40
ARNO



SD58746 32x40
GALILEO



SS-9014 BLACK TIE
32x40 40x60
REAL SUEDE



SS-9018 CRIMSON
32x40 40x60
REAL SUEDE



SS-9097 Rhine
32x40 40x60
REAL SUEDE

W=White Core
32 x 40



Production Collection

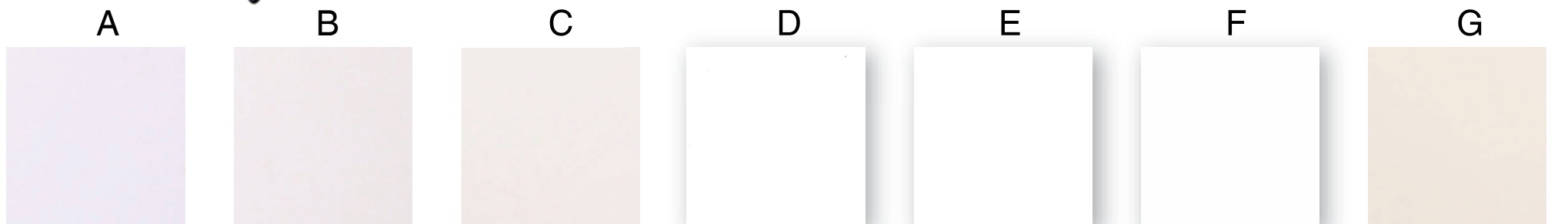

White G 7009 W
GX 7009 W
Dover White G 7010 W
White Cream G 7011 W
GX 7011 W
Soft White G 6050 W
Chalk G 6032 W
Pale White G 6016 W
Light Cream G 7012 W



Ivory G 6020 W
Royal Purple G 6199 W
Wine G 6842 W
Goldenrod G 6871 W
Blaze G 6047W
Chocolate G 6136W
Holly G 6037 W



Rhododendron G 6837 W
Deep Marine G 6860 W
Chesapeake Bay G 6304 W
Navy G 6178 W
Ashford G 6403 W
Charcoal G 6139 W
Black G 7041 W
GX 7041 W

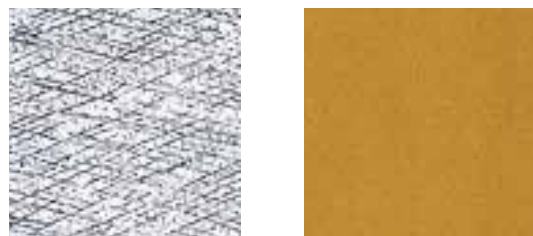

Silver G 6419 W
Venetian Gold G 6123 W

Black = 32" x 40"
Green = 40" x 60"

White core mat boards provide the aesthetic and design benefits of a bright white bevel.

Core and facing paper are buffered with a special glue to formaldehyde reserve of 0-0.5%, alkaline reserve of 3.5%. Fade resistant.

*Bright white core

* Alkaline Reserve 3%-5%

*Fade resistant

*1.4mm thick 4 ply

* Acid Free

WHITECORE

| Colour | Code |
|---------------|--------|
| Navy | SM-001 |
| Merlot | SM-006 |
| Sterling Gray | SM-014 |
| Zucchini | SM-015 |
| Soft Blue | SM-019 |
| Nautica | SM-020 |
| Ruby | SM-022 |
| Candy Pink | SM-037 |
| Fudge | SM-045 |
| Blush | SM-046 |
| Hopi Tan | SM-047 |
| Oyster | SM-051 |
| Sienna | SM-056 |
| Charcoal | SM-057 |
| Clover | SM-062 |
| Autumn Gray | SM-078 |
| Eggshell | SM-079 |
| Brownie | SM-080 |
| Sunflower | SM-090 |
| French Blue | SM-260 |
| Warm White | SM-275 |
| Chestnut | SM-277 |
| Caramel | SM-278 |
| Canary Fluff | SM-279 |
| PacificBlue | SM-280 |
| Ivory | SM-281 |
| Scarlet | SM-282 |
| Cypress | SM-283 |
| Red Rock | SM-284 |
| Cuervo Gold | SM-300 |
| Porcelain | SM-305 |
| Egg Crème | SM-306 |
| Fiesta Blue | SM-309 |
| Satin | SM-311 |
| Purple | SM-312 |
| Polo Green | SM-314 |
| Latte | SM-316 |
| Rosemary | SM-317 |
| Tuscany | SM-318 |
| Burnt Topaz | SM-319 |
| Polar White | SM-328 |
| Sand | SM-401 |
| Sedona Clay | SM-405 |
| Nutmeg | SM-406 |
| Basic Brown | SM-409 |
| Espresso | SM-411 |
| Pecan | SM-412 |
| Tru Black | SM-414 |
| Concord Green | SM-418 |
| Champayne | SM-419 |
| Bayberry | SM-422 |
| Electric Blue | SM-429 |
| Cavalry Red | SM-435 |
| Pumpkin | SM-440 |
| Terracotta | SM-441 |
| Topsail White | SM-450 |

WHITECORE

| Colour | Code |
|------------------|--------|
| TV Gray | SM-456 |
| Salem Black | SM-459 |
| Portrait White | SM-460 |
| Oxford Gray | SM-462 |
| Off White | SM-472 |
| Caribbean Blue | SM-473 |
| Soft Butter | SM-475 |
| Rattan | SM-487 |
| Rubbed Silver | SM-490 |
| Pilsner Gold | SM-500 |
| Tumbleweed | SM-518 |
| Desert Sand | SM-519 |
| Green Safari | SM-650 |
| Molten Lava | SM-651 |
| Summer Green | SM-652 |
| Acorn | SM-653 |
| Ginger Cookie | SM-654 |
| Sea Mist | SM-655 |
| Holiday Red | SM-656 |
| Deep Timber | SM-657 |
| Sweet Potato | SM-658 |
| Rich Butter | SM-659 |
| Southern Moss | SM-660 |
| German Chocolate | SM-661 |
| Sour Apple | SM-663 |
| Oak Leaf | SM-664 |
| Autumn Orange | SM-665 |
| Misty Blue | SM-666 |
| Lime Twist | SM-667 |
| Hot Pink | SM-668 |
| Frosty White | SM-669 |
| Dark Cocoa | SM-670 |
| Blizzard White | SM-671 |
| Tissue White | SM-672 |
| Artist White | SM-673 |
| Cotton | SM-674 |
| Banner Blue | SM-675 |
| Coastal Blue | SM-676 |
| Angora | SM-677 |
| Alabaster | SM-678 |
| Cherry Red | SM-679 |
| Gold Rush | SM-680 |
| Peppered Gray | SM-681 |
| Peppered Gream | SM-682 |
| Peppered Taupe | SM-683 |
| Cape Cod | SM-684 |
| Pewter | SM-685 |
| Shadow | SM-686 |
| Graphite | SM-687 |
| Marine | SM-688 |
| Lavender | SM-689 |
| Emerald | SM-690 |
| Kiwi | SM-691 |
| Pink | SM-692 |
| Snowdrift | SM-900 |

DESIGNER

| Colour | Code |
|----------------|----------|
| Doe Skin | SD-58080 |
| Fallow | SD-58082 |
| Brown Sugar | SD-58083 |
| Moleskin | SD-58322 |
| Quicksand | SD-58323 |
| Mud Puddle | SD-58324 |
| Setting Sun | SD-58326 |
| Adobe | SD-58332 |
| Weeping Willow | SD-58333 |
| Poppy Seed | SD-58334 |
| Sourdough | SD-58360 |
| Candle Wick | SD-58364 |
| Derby | SD-58365 |
| Green Apple | SD-58366 |
| Gingersnap | SD-58367 |
| Cranapple | SD-58374 |
| Picante Red | SD-58375 |
| Woodchuck | SD-58379 |
| Black Night | SD-58440 |
| Dark Camel | SD-58449 |
| Summer Leaf | SD-58456 |
| Biscayne Blue | SD-58464 |
| Seagull | SD-58475 |
| Bar Harbour | SD-58476 |
| Grove Oak | SD-58477 |
| Corn Husk | SD-58478 |
| Turtledove | SD-58479 |
| Aperature | SD-58700 |
| Exposure | SD-58701 |
| Perspective | SD-58702 |

DESIGNER

| Colour | Code |
|---------------|----------|
| Focus | SD-58703 |
| Alpaca | SD-58731 |
| Ochre | SD-58733 |
| Pepper | SD-58738 |
| Arno | SD-58745 |
| Galileo | SD-58746 |
| Dante | SD-58747 |
| Cicero | SD-58748 |
| Florence | SD-58749 |
| Da Vinci | SD-58750 |
| Botticelli | SD-58751 |
| Donatello | SD-58752 |
| Michelangelo | SD-58753 |
| Palazzo | SD-58754 |
| Giotto | SD-58755 |
| Raphael | SD-58756 |
| Sandro | SD-58757 |
| Rippled Moss | SD-58845 |
| Rippled Bark | SD-58846 |
| Rippled Melon | SD-58847 |
| Rippled White | SD-58850 |
| Rippled Taupe | SD-58853 |
| Rippled Sand | SD-58854 |
| Rippled Brown | SD-58857 |
| Southdown | SD-58931 |
| Lasso | SD-58932 |
| Poncho | SD-58933 |
| Chaps | SD-58934 |
| Bridle | SD-58935 |
| Bristol | SD-58872 |

DESIGNER

| Colour | Code |
|------------|----------|
| Brighton | SD-58865 |
| Coventry | SD-58868 |
| Blackpool | SD-58879 |
| Manchester | SD-58880 |
| Leeds | SD-58881 |
| Devon | SD-58873 |
| York | SD-58875 |

FAUX DESIGNER SUEDE

| Colour | CodeGray |
|-----------------|-----------|
| Suede | SDS-58900 |
| Sunflower Suede | SDS-58901 |
| Holiday Suede | SDS-58902 |
| Ruby Suede | SDS-58903 |
| Sienna Suede | SDS-58904 |
| Concord Suede | SDS-58905 |
| Coastal Suede | SDS-58906 |
| Purple Suede | SDS-58907 |
| Nautica Suede | SDS-58908 |
| Cherry Suede | SDS-58909 |
| Navy Suede | SDS-58910 |
| Salem Suede | SDS-58911 |
| Pumpkin Suede | SDS-58912 |

32x44 White Core

| Colour | Code |
|-------------|--------|
| Polar White | SM-328 |
| Tru Black | SM-414 |

BLACK CORE

| Colour | Code |
|----------------|---------------|
| Porcelain | SMB-305 |
| Tru Black | SMB-414 |
| Blizzard White | SMB-671 |
| Blizzard White | SMB-671 40x60 |
| Tissue White | SMB-672 |

SUEDE REAL

| Colour | Code |
|-----------------|----------------|
| Suede Black Tie | SS-9014W 32x40 |
| Suede Black Tie | SS-9014W 40x60 |
| Suede Crimson | SS-9018W 32x40 |
| Suede Rhine | SS-9097W 32x40 |
| Suede Rhine | SS-9097W 40x60 |

40x72 White Core

| Colour | Code |
|----------------|--------|
| Polar White | SM-328 |
| Tru Black | SM-414 |
| Blizzard White | SM-671 |



Standard Paper-Faced Foamboards



DESCRIPTION: Paper-faced memory foamboard with proprietary Reveal foam center; it is engineered to retain its thickness during all applicable fabrications. This product is UV stabilized and highly dent and warp resistant.

LINERS: Features smooth bright-white clay coated or black paper. White liners offer a heavier surface coating for superior ink holdout and excellent colour gloss. The coating acts as a barrier to minimize adhesive absorption while maximizing mounting and lamination speeds.

STANDARD SIZES:
Standard thickness range from 5mm
Standard sheet sizes range from 48"x96"

*CUSTOM CUTS,
COATINGS AND
LAMINATES
AVAILABLE*

- APPLICATIONS:**
- Digital Imaging
 - Exhibits
 - Framing
 - Laminating
 - Litho Mounting
 - Painting
 - Photo Laminating
 - P.O.P Displays
 - Screen Printing
 - Sets and Props
 - Signs
 - Vinyl Graphics

| code | description | single sheet price | box qty |
|-------------|-----------------|--------------------|---------|
| GMRLWH32405 | white 32x40 5mm | \$7.00 | 25 |
| GMRLWH40605 | white 40x60 5mm | \$14.00 | 25 |
| GMRLWH48965 | white 48x96 5mm | N/A | 25 |

Conservation Foamboards



Natural White Acid-Free Conservation Foamboard

DESCRIPTION: Created for conservation mounting and framing, Insite Reveal Acid-Free mounting boards deliver two-sided protection from damaging pollutants and harmful gases. This board is the recommended solution for photographers and artists who require a backing that will add value to high end artwork. Insite Reveal Acid-Free consists of a chemically inert core faced with natural white pH neutral paper liners. Boards are compliant with PAT (Photographic Activity Test) standards. **REVEAL Foam Center:** This chemically inert version of our proprietary REVEAL foam center is highly warp resistant and engineered to retain its thickness during mounting.

LINERS: Our natural white liners offer a PH VALUE ranging from 7.5-9.5 and are buffered with 3-5% calcium carbonate reserve (ASTM IT9.2-191, see. Sec. 5.2) to retain acid free characteristics longer. The liners are 100% High Alpha Cellulose, virgin pulp free from ground wood and/or post consumer materials (ASTM D1030, X5)

- OTHER CHARACTERISTICS ARE:**
- Contains no lignin (TAPPI 236cm-85 KAPPA #5 or less)
 - Free from metallic impurities such as bleach, sulfur and peroxide (TAPPI T406cm-88)
 - Contains no rosin or alum rosin sizing (ASTM D549-88)
 - Is stable under ultraviolet light (TAPPI 452 om-87)

SIZES:
Standard thickness range 5mm
Standard sheets sizes range from 32"x40", 40" x 60" & 48"x96"

- APPLICATIONS:**
- Conservation Framing
 - Dry Mounting

| code | description | single sheet price | box qty |
|-------------|------------------------|--------------------|---------|
| GMCONS32405 | conservation 32x40 5mm | \$11 | 25 |
| GMCONS40605 | conservation 40x60 5mm | \$18 | 25 |
| GMCONS48965 | conservation 48x96 5mm | N/A | 25 |

Heavy-Duty Paper-Faced Foamboards



DESCRIPTION: The New Ryno Board® HD features an incredibly rigid, high compressive foam centre. We've combined this with our NEW high tech, brilliant white, double thick liners resulting in one of the highest performance foamboards ever brought to the graphics market. Whether you print direct digital, screen or mount and laminate, the exceptional properties of this NEW Ryno Board® HD will deliver results.

FOAM CENTER: NEW & IMPROVED: With higher density and outstanding compressive strength, this new foam centre creates greater warp resistance and increased dent resistance.

LINERS NEW & IMPROVED: Double thick, brilliant-white surface liners contribute to the overall strength and durability of Ryno Board® HD. The pH neutral surface contains UV inhibitors to reduce yellowing. The liners resist moisture and humidity, which enhances overall warp resistance. Ryno Board® HD provides a flat surface for screen printing, with excellent ink holdout characteristics. **PHYSICAL ATTRIBUTES:** With higher flexural strength with thermal stability, Ryno Board HD® remains stable after mounting and laminating and is cuff resistant. Ryno Board® HD is recommended for signage and graphics application that require a stronger, more durable substrate.

SIZES:
Standard thickness 5mm, standard sheets 60" x 120"

CUSTOM CUTS, COATINGS & LAMINATES AVAILABLE

- APPLICATIONS:**
- Direct Digital Printing
 - Screen Printing
 - Mounting
 - Exhibits
 - Framing
 - P.O.P Displays
 - Sets and Props
 - Signs
 - Vinyl Graphics
 - Inkjet Printing

| code | description | single sheet price | box qty |
|---------------|-----------------------|--------------------|---------|
| GMRWH60101205 | Ryno board 60x120 5mm | N/A | 16 |

InSite® Reveal® Heat Activated

Heat-Activated Foamboard

- Ready to use - No mounting tissues or films needed
 - Designed for use in mechanical or hot vacuum presses and heated roll laminators
 - Neutral pH heat activated A) adhesive
 - Bonds at 71°C in 15 - 45 seconds in a mechanical press; 71°C in 4 minutes in a hot vacuum press;
- Manufactured in the USA

IDEAL FOR:

- Heat tolerant paper
- Newspaper Poster images
- Resin Coated photographs



InSite® Reveal® Heat Activated (HA) foamboard features an extruded polystyrene foamboard with clay coated liners, one of which is a smooth clay-coated paper on one side and neutral pH heat activated (HA) adhesive on the other. Heat activated foamboards are designed for use in mechanical and hot vacuum presses as well as heated roll laminators. Since InSite® HA board comes with a layer of smooth, evenly applied adhesive coating it is ready to use out of the case by eliminating the need for rolled mounting tissues or films. This saves production time and money, whether a single custom mount or large production operation. Available in white 5mm 32x40 & 40x60, 48x96



| code | description | single sheet price | box qty |
|-----------|--------------------------|--------------------|---------|
| GMHA32405 | heat activated 32x40 5mm | \$11.5 | 25 |
| GMHA40605 | heat activated 40x60 5mm | \$21.5 | 25 |
| GMHA48965 | heat activated 48x96 5mm | N/A | 25 |

InSite® Reveal® Self Adhesive

InSite Reveal Self Adhesive is an extruded polystyrene foamboard featuring the proprietary Reveal® memory foam centre faced on one side with smooth, clay coated paper in High-Tack (black liner) cold pressure-sensitive adhesive surface on the other covered by a protective release liner. InSite Reveal Self Adhesive High-Tack is an aggressive adhesive that immediately grabs to smooth paper and photo media so correct placement the first time is essential. Once applied, manually burnish, place in cold vacuum press, or feeding through cold rollers—as above—to fully activate the adhesive.

Available white 5mm from 32"x 40", 40"x60" and 48"x 96".

Manual application is quick and easy with simple peel and stick use.

- Remove protective release liner from sized board
- Place liner between print and P-S board allowing a few inches to attach at top edge
- Square to edge of board, and press to hold
- Slip liner down P-S board while following to smooth and prevent trapped air
- Once placed, cover with release liner and firmly adhere

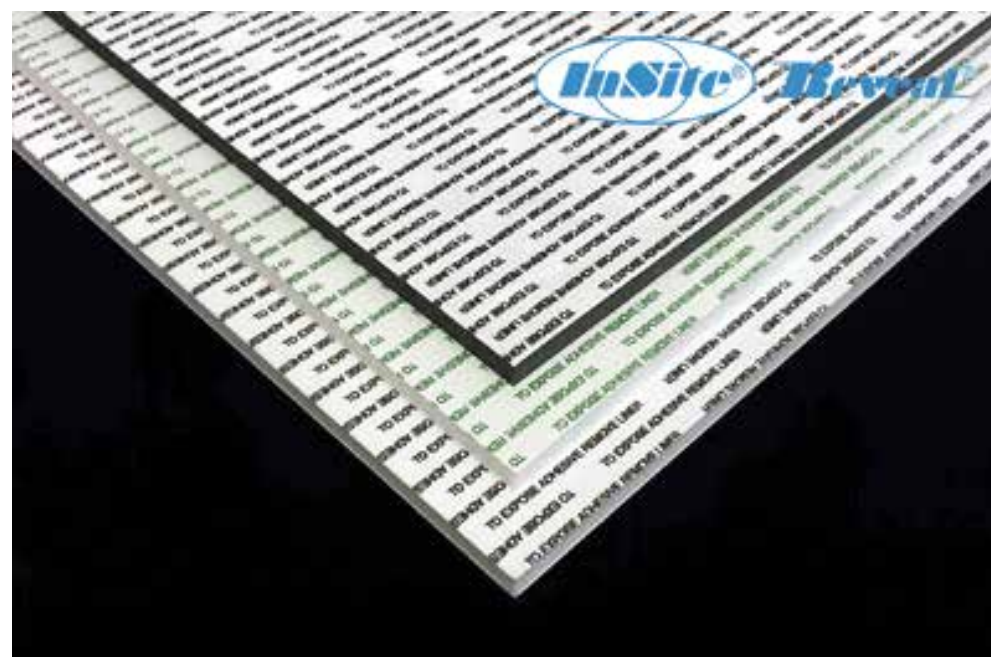

| code | description | single sheet price | box qty |
|---------------|--------------------------|--------------------|---------|
| GMRYLWH32405A | white 32x40 5mm adhesive | \$17 | 25 |
| GMRYLWH40605A | white 40x60 5mm adhesive | \$30 | 25 |
| GMRYLWH48965A | white 48x96 5mm adhesive | N/A | 25 |



FOAMBOARD

Black acid free foamboard

Acid free white foamboard

Standard quality foam board with multi and general applications. White polystyrene foam core and high quality clay coated matte paper liners on both sides. It is a widely used foam board and suitable for a variety of applications. Premium quality laminated foamboard, durable clay coated for a super smooth surface

Applications: Suitable for short term, indoor fast and easy applications including picture framing, photo mounting, screen printing, laminating and making POP/POS displays, exhibit signs, graphic arts and creative models.

Features: Smooth, flat, stiff, bright white, and pH neutral surface, easy to cut trim and process good for die-cutting and screen printing

| Code | Size | Thickness | Box Qty |
|------------|--------|-----------|---------|
| FBW32403 | 32X40 | 3mm | 40 |
| FBW32405 | 32X40 | 5mm | 25 |
| FBW324010 | 32X40 | 10mm | 15 |
| FBW40603 | 40X60 | 3mm | 40 |
| FBW40605 | 40X60 | 5mm | 25 |
| FBW406010 | 40X60 | 10mm | 15 |
| FBW406020 | 40X60 | 20mm | 10 |
| FBW48963 | 48X96 | 3mm | 30 |
| FBW48965 | 48X96 | 5mm | 25 |
| FBW489610 | 48X96 | 10mm | 15 |
| FBW601205 | 60X120 | 5mm | 20 |
| FBW6012010 | 60X120 | 10mm | 10 |

Adhesive white foamboard

White polystyrene foam core and plastic coated paper liners on both sides with high tack self-adhesive surface on one side under silconized release paper liner. Excellent performance mounting board low cost and in wide formats

Applications: Photo mounting, picture framing, making exhibit signs and displays

Features: Ready to use once you remove release therefore saving you money, easy to cut, trim and process. Smooth flat, stiff, bright white, and pH neutral surface, permanent acrylate high tack-adhesive.

| Code | Size | Thickness | Box Qty |
|-------------|--------|-----------|---------|
| FBW32403A | 32X40 | 3mm | 40 |
| FBW32405A | 32X40 | 5mm | 25 |
| FBW324010A | 32X40 | 10mm | 15 |
| FBW40603A | 40X60 | 3mm | 40 |
| FBW40605A | 40X60 | 5mm | 25 |
| FBW406010A | 40X60 | 10mm | 15 |
| FBW406020A | 40X60 | 20mm | 10 |
| FBW48965A | 48X96 | 5mm | 25 |
| FBW601205A | 60X120 | 5mm | 20 |
| FBW6012010A | 60X120 | 10mm | 10 |

Black polystyrene foam core and black paper liners on both sides

Applications: Display board for presentation posters, photos, picture framing, photo mounting and graphic arts.

Features: Attractive and harmonious all black visual effect easy to cut, trim and process pH neutral, smooth and rigid.

| Code | Size | Thickness | Box Qty |
|-----------|-------|-----------|---------|
| FBB32403 | 32X40 | 3mm | 40 |
| FBB32405 | 32X40 | 5mm | 25 |
| FBB40603 | 40X60 | 3mm | 40 |
| FBB40605 | 40X60 | 5mm | 25 |
| FBB406020 | 40X60 | 20mm | 10 |

Adhesive black foamboard

Black polystyrene foam core and black paper liners on both sides with one side high tack adhesive surface under silconized release line

Applications: Display board for presentation, picture framing, photo and poster mounting.

Features: Ready to use saves time and money, attractive black visual effect easy to cut, trim and process, pH neutral smooth and rigid, permanent high tack acrylic adhesive.

| Code | Size | Thickness | Box Qty |
|------------|-------|-----------|---------|
| FBB406020A | 40x60 | 20mm | 10 |
| FBB40605A | 40x60 | 5mm | 25 |
| FBB406010A | 40x60 | 10mm | 15 |

Repositionable white adhesive foamboard

Removes the annoyance and risk out of your mounting problems they are sturdy, lightweight and easy to cut. These foamboard are coated with a pressure sensitive "cold" adhesive and is sticky to touch.

Repositionable foamboard make mounting easy by eliminating bubbles or imperfections during the mounting process.

Applications: Photo mounting, picture framing, making exhibit signs and displays

Features: No bubbles and easy to mount, during mounting you can remove and reposition. Smooth, flat, stiff bright-white, and pH neutral surface.

| Code | Size | Thickness | Box Qty |
|------------|-------|-----------|---------|
| FBW32405RE | 32X40 | 5mm | 25 |
| FBW40605RE | 40x60 | 5mm | 25 |



Barrier, Drawing & Framing paper

Description

This paper was designed for artists who think and operate on a grand scale. The off-white tone and supple vellum texture make this paper every bit as luxurious as it is functional. Exclusively available in 60" and 72" rolls this grade lends itself to large pieces of work.

Artists are no longer beholden to the size limitation of sheets and can let their imagination roam the length of these 18.28mts rolls.

Aside from its size it's also a popular paper because of its versatility, being suitable for so many different applications:

For conservation framing & matting they are excellent backing papers

- The level, slight textured surface make them ideal for all drawing techniques and because of roll sizes in warm white artists can expand their creativity by working larger.
- The great dimensionally stability make it perfect paper for silkscreen as the rolls can be sheeted or torn to size.
- Its modestly surface sized making it also suitable for offset printing and light wet-media applications as well as all drawing techniques.

Companion to this grade in sheets is Rising Barrier Paper in 32 x 40.

Specifications:

- Made in USA
- Neutral pH
- Lignin Free
- Wide rolls for larger works
- 100% Cotton
- Acid Free
- Chlorine Free
- Specialty Paper

Applications:

- Conservation & Restoration
- Matting & Framing
- Pastel & Charcoal
- Silkscreen

RLBARWH6020 1520mm wide x 18.28mts long 250gsm

RLBARWH7220 1830mm wide x 18.28mts long 250gsm

Silicone Coated Release Board

Seal release board is smooth thin cardboard coated with silicone on both sides. They are extremely durable, reusable and easy to handle. Release Boards protect your artwork and keep your press clear. They are ideal for holding curled materials flat, on oversized work mounted in any heat press. Size is 1016mm x 1524 x 1.8mm
RELEASE B 40x60



Foam Sponge Overlay – 5mm

Used to facilitate the laminating process when using pre-pierced heatseals. Air between the film and print is pressed out through the foam and continued heat and pressure heals up the holes and – on untextured films – results in the pleasing stippled finish traditionally associated with heatsealing.

FOAMSHEETA 1295mmx 2590mm x 5mm thick



FusionÂ® 4000

FusionÂ® 4000 is a pure, ultra-clear, thermal-activated, 100% inert adhesive film that melts during heating, bonds as it cools and is removable when reheated. It can be used to mount litho prints, newsprint, photographs, art papers, engravings, silk, canvas, foils and other papers. It also is ideal for mounting different shapes and sizes. It is a good general purpose mounting film.

Recommended temperature 79C

Available in the following sizes

- FMB1 622mm x 27mts x 75mm
- FMB2 1029mm x 27mts x 75mm
- FMB3 1232mm x 27mts x 75mm



N.T.M.T. Mounting Tissue

A unique development of dry mounting tissue that can be used to mount a wide variety of prints onto a broad range of substrates. It offers good economies for contract framers and other busy mounting houses.

Available in the following sizes

- FMC1 622mm x 25mts x 75mm
- FMC2 1040mm x 25mts x 75mm
- FMC3 1245mm x 25mts x 75mm

BufferMount®

BufferMount™ is the safest mounting option available. It has an acid-free reversible adhesive either side of an alkaline buffered tissue paper and its low operating temperature is an extra safeguard. Archival quality dry mount film.

Recommended temperature 79C

- FMA1 622mm x 27mts x 75mm
- FMA2 1029mm x 27mts x 75mm

Release products

Recommended as cover sheets both to protect artwork from direct contact with heated platens and also to avoid any exposed adhesive sticking to the press.

Two sided Clear silicon Release Film

A siliconised polyester release film that can be used to gloss up Texture Film or for protection during standard mounting processes.



- FMD1 1070mmx 25mts
- FMD2 1300mmx 10mts

One sided release paper

Fairly light one-sided release paper, generally one use only, for protective use when mounting to avoid any excess tissue sticking to the press

- FMF1 1070mm x 10mts

Two sided release paper

Heavy duty two sided siliconised paper offering good protection in all types of presses against damage, creasing and unwanted adhesion.

- FME1 1067mm x 27mts

CODE: BRJAGUAR

PRICE: POA



Jaguar

Double Mitre Saw

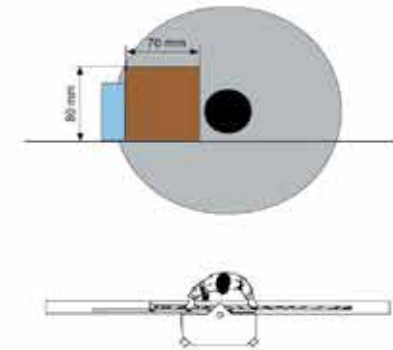
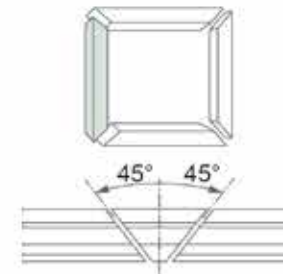

Main Characteristics

Pneumatic double mitre sawing machine, for "V-cutting" at 45° degrees, at both ends, in wooden mouldings of any shape and kind (all woods-aluminium covered, etc.). Precise graduate scale to gage at the rabbet of the mitred mouldings, right sliding stop and vertical pneumatic clamps. **With fixed fence.** Maximum operator safety. Sound level: LAeq > 85 dB (A). Arranged to be connected to a suction unit with min. delivery of 700 m³/h for each sawdust exhaust outlet.

| | |
|--------------------------------|--|
| Blades: | 2 circular carbide saw blades \varnothing of 275mm. (10 7/8" diameter) (size bore \varnothing 32 mm.- 1 1/4"). |
| Max. cutting capacity: | width 70mm (2 3/4") height 80mm (3 1/2") |
| Production rate: | about 200 cuts per hour (it varies with mouldings dimensions). |
| Standard electric equipment: | 2 motors of 1,5 Hp each; Voltage 400/440 V; 50/60 Hz; 2800 RPM; 3 Phases. On request machine can be supplied with electric equipment according to local voltage and hertz. In this case electric characteristics change. Electric consumption max. 3 Kw. (single phases on request). |
| Sawdust exhaust outlets: | N. 2, diameter 100 mm. (3 15/16"). |
| Overall dimensions and weight: | width 880 mm. (34 5/8"); length 1130 mm. (44 1/2"); height 1380 mm. (54 3/8"); 240 Kg. (529 lbs.). |

Particularly suitable for woodworking shops and custom picture frames.

CODE: BRPRISMATICE

PRICE: POA



Prismatic E

Double Mitre Saw



- Two hand control valves for cycle initiation
- 2 saw blades type HM d. 250mm, size bore
- 2 moulding supporting arms
- Adhesive measuring system l=1000mm

Right sliding stop

Horizontal pneumatic clamps

Air/oil filter

Clamping timing device

Possibility to use blades d. 275mm



Optional T024

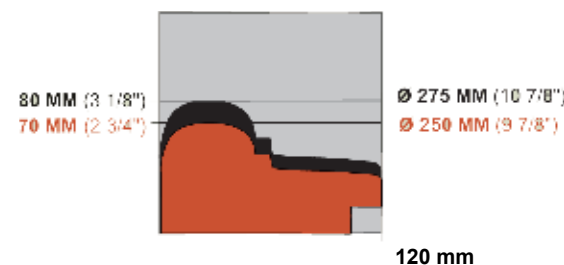

Main Characteristics

Manual sawing machine, with pneumatic horizontal stroke, for "V-cutting" at 45 degrees, at both ends, in mouldings of any shape and kind. Possibility to use saw blades from 250mm (9 7/8") up to 275mm. (10 7/8"), size bore ø 32mm. Precise graduate scale to gage at the rabbet of the mitred mouldings. The horizontal pneumatic clamps and the right sliding stop are standard. With fixed fence. Digital readout as optional (T024). Maximum operator safety. Sound level: LAeq > 80 dB (A). Arranged to be connected to a suction unit with min. delivery of 700m³/h for each sawdust exhaust outlet.

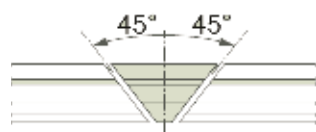
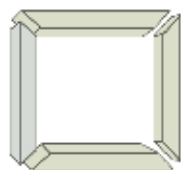

- | | |
|--------------------------------|---|
| Saws: | 2 circular carbide saw blades of 250mm. (9 7/8") (size bore ø 32mm. -1 1/4"). |
| Max. cutting capacity: | see cutting diagram |
| Production rate: | About 250 cuts per hour (it varies with mouldings dimensions). |
| Standard electric equipment: | 2 motors of 1,5 Hp each 2800 RPM; Voltage 230 V- 50 Hz-1 Ph. On request machine can be supplied with electric equipment according to local voltage and hertz. In this case electric characteristic change. Electric consumption max. 2,2Kw. (3 phase available on request) |
| Sawdust exhaust outlets: | N. 2, diameter 100 mm. (3 15/16"). |
| Overall dimensions and weight: | width 1300 mm. (51 1/8"); length 760 mm. (30"); height 1100 mm. (43 1/4"); 185 Kg. (407 lbs.). |

Particularly suitable for medium and small production of frames.

MACHINERY



CODE: BRPRISMA CE

PRICE: POA



Prisma CE

Double Mitre Saw

2 saw blades type HM d. 250mm, size bore d. 32mm
 2 mouldings supporting arms l=750mm (1 right, 1 left)

Adhesive measuring system l=1000mm

Right sliding stop

Mechanical horizontal clamps

Possibility to use saw blades d. 275mm



Optional T024

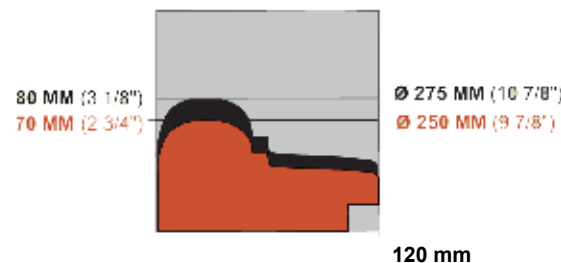

Main Characteristics

Manual sawing machine, with pneumatic horizontal stroke, for "V-cutting" at 45 degrees, at both ends, in mouldings of any shape and kind. Possibility to use saw blades from 250mm (9 7/8") up to 275mm. (10 7/8"). Precise graduate scale to gage at the rabbet of the mitred mouldings, right sliding stop and mechanical horizontal clamps. With fixed fence. Digital readout as optional (T024). Maximum operator safety. Sound level: LAeq > 80 dB (A). Arranged to be connected to a suction unit with min. delivery of 700m³/h for each sawdust exhaust outlet.

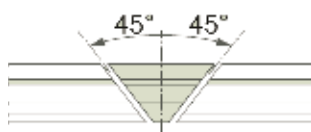
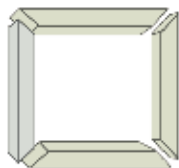

| | |
|--------------------------------|---|
| Saws: | 2 circular carbide saw blades of 250mm. (9 7/8") (size bore ø 32mm. -1 1/4"). |
| Max. cutting capacity: | see cutting diagram |
| Production rate: | About 200 cuts per hour (it varies with mouldings dimensions). |
| Standard electric equipment: | 2 motors of 1,5 Hp each 2800 RPM; Voltage 230 V- 50 Hz-1 Ph. On request machine can be supplied with electric equipment according to local voltage and hertz. In this case electric characteristic change. Electric consumption max. 2,2Kw. (3 phase available on request) |
| Sawdust exhaust outlets: | N. 2, diameter 100 mm. (3 15/16"). |
| Overall dimensions and weight: | width 1180 mm. (4 6 1 / 2 ") ; l e n g t h 670 mm. (26 3/8"); height 1100 mm. (43 1/4"); 165 Kg. (363 lbs.).. |

Particularly suitable for medium and small production of frames.

CODE: BRPRISMAMAXI

PRICE: POA



Prisma Maxi

Double Mitre Saw



2 saw blades type HM d. 275mm, size bore d. 32mm

2 moulding supporting arms l=1330mm (1 right, 1 left)

Adhesive measuring system l=2000mm

Right sliding stop

Mechanical horizontal clamps

Possibility to use saw blades d. 250mm



Optional T024

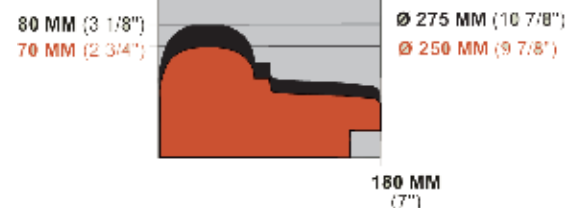

Main Characteristics

Manual sawing machine, with horizontal stroke, for "V-cutting" at 45 degrees, at both ends, in wooden mouldings of any shape and kind (all woods-aluminium covered, etc.). Possibility to use saw blades from \varnothing 250mm (9 7/8") up to 275mm. (10 7/8"). Precise graduate scale to gage at the rabbet of the mitred mouldings, right sliding stop and mechanical horizontal clamps. With fixed fence. Digital readout as optional (T024). Maximum operator safety. Sound level: LAeq > 80 dB (A). Arranged to be connected to a suction unit with min. delivery of 700m³/h for each sawdust exhaust outlet.

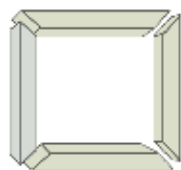

Saws: 2 circular carbide saw blades of 275mm. (10 7/8") - (size bore \varnothing 32 mm. - 1 1/4").

Max. cutting capacity: see cutting diagram

Production rate: About 200 cuts per hour (it varies with mouldings dimensions).

Standard electric equipment: 2 motors of 1,5 Hp each 2800 RPM; Voltage 230 V- 50 Hz-1 Ph.

On request machine can be supplied with electric equipment according to local voltage and hertz. In this case electric characteristic change. Electric consumption max. 2,2Kw. (3 phase available on request)

Sawdust exhaust outlets: N. 2, diameter 100 mm. (3 15/16").

Overall dimensions and weight: width 1380 mm. (54 5/16"); length 760 mm. (30"); height 1150 mm. (45 1/4").

Particularly suitable for medium and small production of frames.

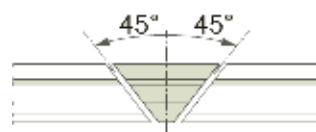



CODE: BRC18PLUS

PRICE: POA



C 18 PLUS

Double Mitre Saw

Max cutting capacity: 102mm width (with saw blades dia. 380mm) - 100mm height.

Operation: electro-pneumatic

Voltage: 400V 50Hz - 3Ph

2 saw blades HM d. 350mm, size bore d. 32mm

Hand control valves for cycle initiation

3 moulding supporting arms l=1000mm (1 right, 2 left)

Adhesive measuring system l=1000mm

Right pneumatic sliding stop

Double vertical pneumatic clamps

Air filter

Waste pieces support with blow out device

Clamping timing device

Foot operated valve for vertical clamping

Possibility to use saw blades from 275mm to 380mm Ø

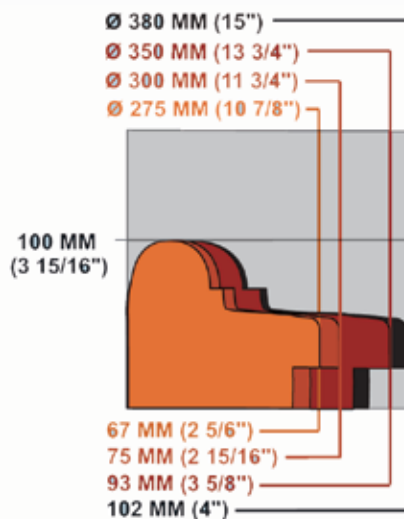
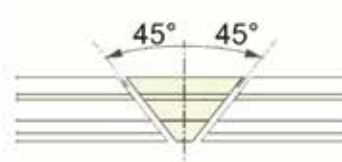
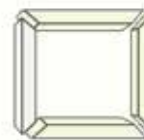

Main Characteristics

Manual sawing machine, with horizontal stroke, for "V-cutting" at 45 degrees, at both ends, in wooden mouldings of any shape and kind. Possibility to use saw blades from 275mm (10 7/8") up to 380mm. (15"). Precise graduate scale to gage at the rabbet of the mitred mouldings, right sliding stop and double vertical pneumatic clamps. With fixed fence. Maximum operator safety. Sound level: LAeq > 80 dB (A). Arranged to be connected to a suction unit with min. delivery of 700m³/h for each sawdust exhaust outlet.

Saws:

2 circular carbide saw blades of 350mm. (13 3/4") (size bore Ø 32mm - 1 1/4).

Max. cutting capacity:

see cutting diagram

Production rate:

About 300-400 cuts per hour (it varies with mouldings dimensions).

Standard electric equipment:

2 motors of 2Hp each; Voltage 380/440V - 50/60Hz; 3 Phases. On request machine can be supplied with electric equipment according to local voltage and hertz. In this case electric characteristic change. Electric consumption max. 3 Kw

Sawdust exhaust outlets:

N. 2, diameter 100 mm. (3 15/16").

Overall dimensions and weight:

width 1280 mm. (50 3/8"); length 900 mm. (35 1/2"); height 1580 mm. (62 3/16"); 376 Kg. (827 lbs.).

Particularly suitable for medium and large productions of furniture, picture and photo frames in mouldings of small dimensions.

APROCUT 350 Double Mitre Saw

Foot Operated Guillotine

The saw for the custom framer and the volume production factory. The pro-cut saw is purpose designed for the picture framing industry. By a design/service engineer experienced in the industries requirements.

You can select single phase or 3phase factory installation.

CODE: APRO-350

PRICE: POA

140mm Wide Cut

Note: some features of this machine have been overdesigned on purpose to ensure that you will have a robust reliable machine.

Features:

- Apro-cut 350 is a pendulum arm double mitre saw.
- Adjustable blade down feed speed control.
- Four (4) vertical clamps
- clamp pressure only regulator.
- Clamps down for setting only switch.
- Front safety glass viewing window with internal cabinet light.
- Fully shrouded scrap and dust extraction pathways.
- Two hand unison safety system for operator protection.
- Mushroom head light pressure operating palm buttons.
- High fence with thumb grasp control cutout.
- Automatic blade return selector switch.
- Micro adjustment of 45 degree saw angles.
- Regulator moisture trap and lubricator at air
- 1500 infeed and outfeed tables.
- Measuring scales on outfeed table.
- Measuring scales on top of outfeed fence.
- Cabinet open electrical cutout safety switch.

Optional extras:

- Additional clamps for wide moulding cuts up to widths of 150mm.
- 2000mm outfeed table with scales.
- Dust extractor system twin outlet.
- Braked electric motors.

Technical specifications:

- apro-cut 350 double mitre saw
- blade 350mm 30mm bore
- motor single phase or 3 phase as selected
- 1.5 hp @ 2850 rpm.
- Pneumatic feed control system @ 8opsi.
- Pneumatic two hand safety operating system.
- Production potential photo frames 850 cuts/hr.
- Weight 225kg
- dimensions 900x700x1 380mm.
- Work deck height 910mm.
- Dust extraction connection 2x100mm dia
- electric power control on button with panic stop/reset.

APRO-CUT 350



MADE IN AUSTRALIA

Framers Corner Foot Operated Guillotine

CODE: GUILLOF



Specifications

- Max cutting Width 100mm 4"
- Max Cutting Height 160mm 6.5/16"
- Max Length Measurement 1500mm 60"
- Fence swivels from 45 to 90°

Features

Great care has been paid to the production of our knives; the type of steel used, it's preparation and it's finishing. We know that frame makers require perfect mitring and that demands perfect knives. Both standard and reversible knives are available and they will also fit Morso and Hansen guillotines.

All major parts such as the mitring head, main table and measuring table are made from cast iron to ensure long life. The guillotine body is designed to give maximum rigidity and to be pleasing to the eye.

Two rebate supports provide perfect control over the moulding, they can quickly be adjusted to the height of the rebate and will prevent tearing or splintering of the rebate edge.

Most frames require 90 degree corners but for the occasional production of 6 or 8 sided frames, the fences will pivot and can be accurately set at the required angle.

Sharp knives are always dangerous but less so with our Safety Guard which should always be used by lowering it as far as the height of the moulding will allow.

Keeping tidy is easy with our waste chute which is supplied as standard with a heavy duty, reusable polyurethane bag.

Dust Collector

Portable dust extractor with one top filter bag and one bottom collection bag



- 125mm (5") diameter main inlet to fan cowling
- Plastic adaptor on inlet with 2 x 4" inlets
- 2hp single phase motor with switch, cord and plug
- Sheet steel construction of base, cyclone, fan cowling and connecting duct from fan to cyclone drum
- Four strong wheel-type castors on base for mobility
- Needle felt top filter bag to allow free travel of air and retain fine dust
- Disposable bottom collection bag of thick clear plastic
- Motor on fan mounted low down on base of machine, to prevent unit tipping over when moved
- Air through put of approximately 1300 fcm
- Nett weight of complete machine-47kgs

DUST COLLECT dust collector with 2 hp motor
 HOSE F4 100mm hose for dust collector
 HOSE CLAMP 4 inch hose clamps for hose



HOSE F4



HOSE CLAMP

Air Compressors

CODE: CM50/24



AMS CM50 Air Compressors are ideal for operation in small workshops with on underpinner and a stapler.1/2 HP delivered from onemotor with 2.15 CFM Free.

- .Air Pressure=up to 120 psi (8 bar)
- .Pressure cycle=85-115 PSI
- .Shipping weight=32kg
- .Delivers 50 liters/minute
- .Single phase 10 amp

CODE: CM99/24



AMS CM99 Air Compressors ideal for workshops with up to two underpinners operating simultaneously or over a long period of time daily.Each machine has 1 HP delivered from two motors with 435 CFM Free Air.Wheels are attached for ease of movement.

- .Air Pressure=up to 120 psi (8 bar)
- .Pressure cycle=85-115 PSI
- .Shipping weight=46kg
- .Delivers 100 liters/minute
- .Single phase 10 amp

AMS
art materials service

COALESCENT FILTER FOR SILENT COMPRESSORS CHANGE EVERY 6 MONTHS

CM3C0985



AMS
art materials service

AIR INTAKE FILTER FOR SILENT COMPRESSORS CHANGE EVERY 6 MONTHS

CM3C1794



Roloil

SINCOM/32E SYNTHETIC COMPRESSOR OIL FOR SILENT COMPRESSORS 500 ml BOTTLE

CM3C1790



CODE: BRSIMPLE

PRICE: POA



SIMPLE

Joining Machine for Frames

- Loader for staples type PV or NP (depending on your needs, interchangeable)
- Sliding 90° guide to fix staples in two preset positions safety shield
- Automatic working cycle device that prevents marks on the top of the mouldings

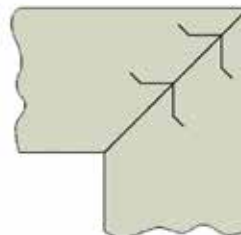
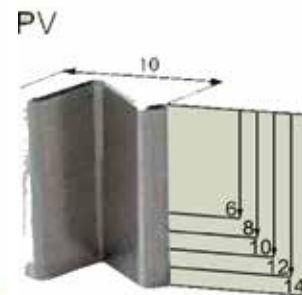

BRSIMPLEA014Z Stand
BRSIMPLEA032R Pv nailing conversion kit
BRSIMPLEA042G Np nail conversion kit

Main Characteristics

Pneumatic joining top table machine for the assembly of any shape and kind of frames either with four, six or eight sides, even curves. The mitred pieces of mouldings to be joined are connected tightly by a steel nail type PV (for very soft, soft, medium woods and plastic) and type NP (for hard, very hard woods and for compact materials as MDF). The two loaders are interchangeable on the same machine. These nails are in strips and according to the height of mouldings there are different sizes available. Machine equipped with automatic device that prevents marks the top of the moulding during joining operation. It is possible to set nails in 2 or more different position and drive more nails one behind the other into the back of the mouldings. no electric power is required. Easy to use. The machine is capable of joining mouldings of following dimensions: Min. width 10mm(3/8") height 8mm (10/32"); max.width 100mm (3 15/16") height 60mm (2 3/8"). Sound level: LAeq < 74 dB (A).

Compressed air: 6 bars; consumption 6 NI/Cycle and about 120 NI/Min.
Weight: 24 Kg. (53 Lbs).
Overall dimensions: Width 360 mm (14 1/4"); Length 520 mm (20 1/2"); Height 580 mm (22 7/8").

Particularly suitable for bespoke frames, door or furniture manufacturers with small quantities in production.

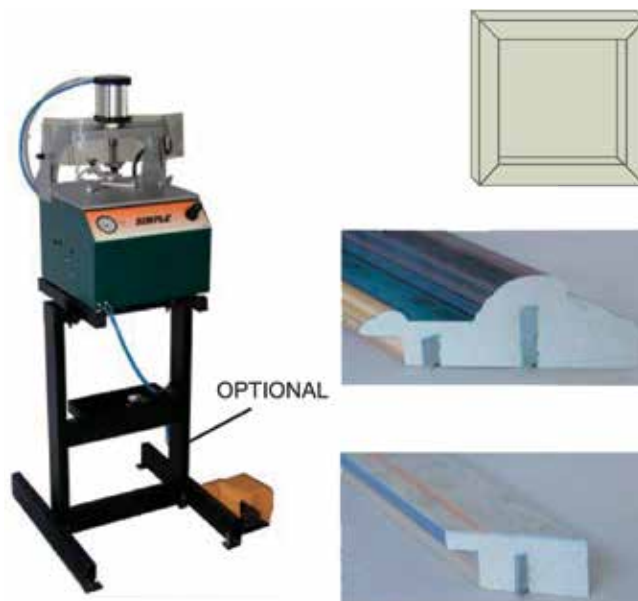

OPTIONAL

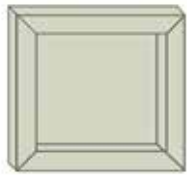
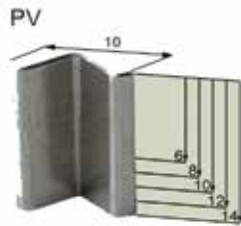
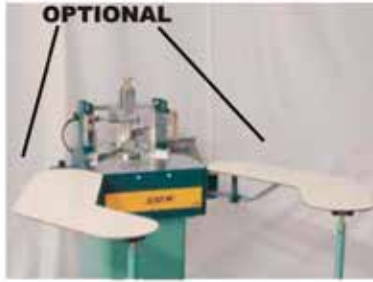

Main Characteristics

Pneumatic joining machine with manual shifting of the loader for any kind and shape of frames, either with four sides. The mitered pieces of mouldings to be joined are connected tightly by a steel nail. Nailing unit for nails type NP (for not too hard and hard woods and compact materials as MDF) or type PV (for very soft, soft, not too hard woods and plastic). The loaders are interchangeable in the same machine. The machine may be used in tilted position that allows the operator to work from machine front or rear side. It is possible to set nails in many different positions and to insert more nails one behind the other in each position. Standard with horizontal clamp and adjustable guide. Sound level: LAeq < 70.1 dB (A).

| | |
|---|--|
| <p>Dimensions of mouldings to join:</p> <p>Production rate:</p> <p>Compressed air: 6 bars.;</p> <p>Overall dimensions and weight:</p> | <p>Max. width 200mm. (7 7/8") (140mm (5 1/2") with horizontal clamp mounted) height 150mm. (5 7/8")</p> <p>Min. width 4mm. (5/32") with PV nails 5mm (6/32") with NP nails - height 7mm. (9/32")</p> <p>About 200/300 complete frames per hour (it varies with frames dimensions and the number of nails in each corner).</p> <p>consumption about 20 NI/Cycle.</p> <p>width 500mm. (19 3/4"); l.600mm. (23 1/2"); h. 1250mm.(49 1/4"); 96 kg (211 lbs).</p> |
|---|--|

Particularly versatile machine, suitable with medium and large dimensions frames.



CODE: BRS30DEKOR

PRICE: POA

S30 Dekor

Joining Machine for Frames

- Loader for staples type PV or NP (depending on your needs, interchangeable)
- Sliding loader to shift manually
- Possibility to set staples in different positions. Loader stroke 180mm
- Possibility to set more staples (one behind the other) in each position easily
- Mechanic vertical clamps
- Fixed fence
- Safety shield
- Air-oil filter

Parts for S30 Dekkor

BRS30A008Q Extension table
 BRS30A032Z Pv nailing conversion kit
 BRS30A042G Np nailing conversion kit
 BRS30A028A Retrofit kit hydraulic hold down vertical clamps
 BRS30MA24A Hydraulic cylinders with stand hold instead of mechanical vertical clamps

CODE: BRSIGMA2100

PRICE: POA



BREVETTI MOTTA
Sigma 2100

Joining Machine for Frames

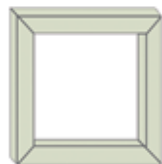
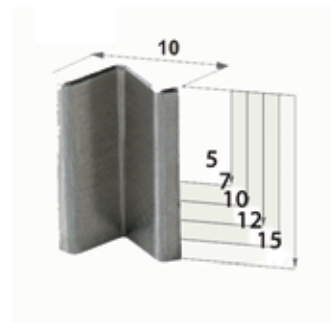

- Loader staples type PV or Np (depending on your needs, interchangeable)
- automatic device to set staple up to 10 different positions (adjustable)
- Working cycle completely
- Selectors to set from 1 to 4 staples (one behind the other) in each present position
- automatic horizontal clamp
- adjustable fence
- fence to set at 45 degrees-22,5 degrees
- possibility to memorize up to 520 working cycles
- safety shield
- air-oil filter

Main Characteristics

Electropneumatic joining machine for the assembly of any shape and kind of frames either with four, six or eight sides. The mitered pieces of mouldings to be joined are connected tightly by a steel nail type PV (for very soft, soft and not too hard woods and plastic) or type NP (for hard, very hard wood and MDF). The two loaders are interchangeable on the same machine. These nails are in strips and according to the height of the mouldings there are different sizes available. Possible to insert nails automatically in up to 10 different pre-set positions along the base of the moulding, to stack up to 4 nails in each position and to memorize different working programmes. The special electronic control box can be easily used by the operator to select or modify the working program and to check all movements of the machine. The machine is capable of joining mouldings from 4mm (5/32") in width with PV nails and 7 mm. (9/32") in height up to 120 mm. (4 3/4") in width and 70mm (2 3/4") in height. The horizontal clamps are standard, electronic control with touch colour screen, automatic nails loading, 3 working speed. Sound level: LAeq < 73.1 dB (A).

Production rate: About 250-300 complete frames per hour (it varies with frames dimensions and the number of nails in each corner).

Compressed air: 6 bars; consumption about 40 NI/Cycle

Electric power: 220/240V 1Ph 50/60Hz max. consumption 0,4 Kw.

Overall dimensions and weight: w. 790 mm.(31 1/8"); l. 850 mm.(33 1/2"); h. 1.300 mm.(51 1/8").; 143 Kg.(315 Lbs).

Particularly suitable for furniture, picture and photo frames with medium quantities in production. □

M3 Underpinner The M3

underpinner has a unique two pedal system. The right hand pedal operates the moulding rebate clamp which securely grips the moulding from the front before pinning. When adjusting the fence, to insert a second wedge, the rebate clamp also travels with it, so that the moulding always remains tightly clamped. The left hand pedal has a dual action: Firstly the top pressure clamp is lowered so that the moulding is now clamped in two directions. Secondly the wedge is inserted underneath the moulding. To increase simplicity, a green indicator light illuminates when the wedge has been fully inserted and the operation is finished.

A sliding fence allows for multiple wedges (also known as V nails) to be inserted into the same corner. There is a front and back limit stop, which can be set to keep wedge positions accurately placed. When using tall mouldings the fence can be locked in position to allow wedges to be stacked two on top of each other, therefore two 10mm wedges become a 20mm wedge.

Supplied with two extension tables, L shaped pressure pad, round pressure pad, pedal restrictor for smaller mouldings, adjustable rubber feet and magnetic wedge remover.

- _ Front Rebate Clamp
- _ Top Pressure Clamp
- _ Cycle Completed Light
- _ V-nails from 7mm to 15mm
- _ Extension

Tables included

Floorstand included

Production Stops included

PRICE: POA



2 Pedal Design

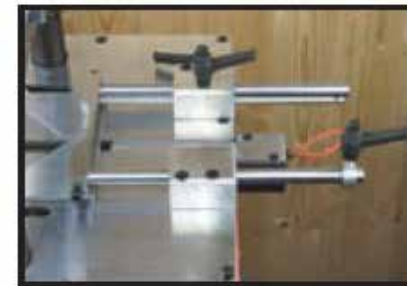

Production Stops

| M3 Specification | |
|-------------------------------------|------------------------|
| Moulding Width (Using Rebate Clamp) | 0-60mm |
| Moulding Width (Without Clamp) | 0-100mm |
| Moulding Height | 0-100mm |
| Pin Placement from Back Corner | 0-110mm |
| Wedge Sizes | 7 to 15mm |
| Dimensions (W x D x H) | 730mm x 800mm x 1110mm |
| Weight | 30kg |
| Rating | Trade |

PRICE: POA

The Ultimate Wall Cutter KEENCUT Excalibur 5000

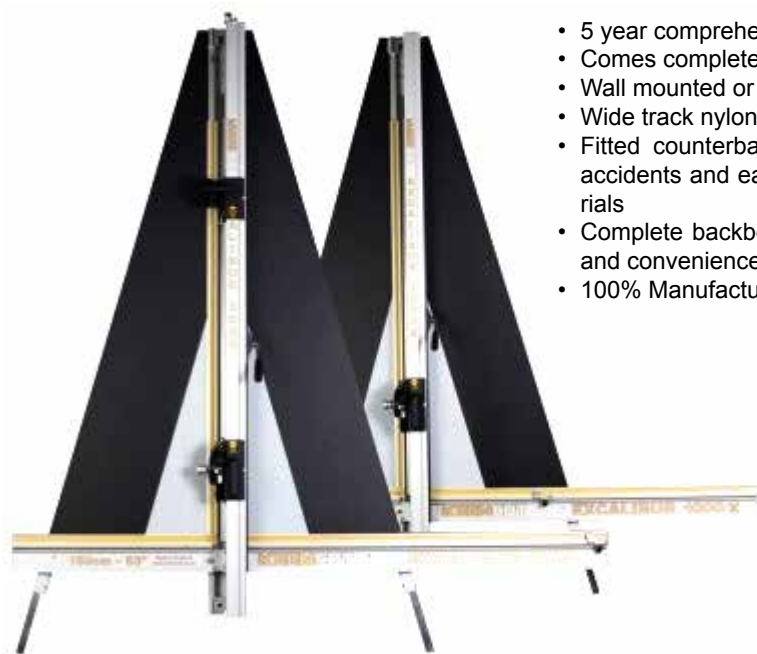

- 5 year comprehensive warranty
- Comes complete - no extras to buy
- Wall mounted or free-standing
- Wide track nylon bearing system
- Fitted counterbalance; less fatigue, accidents and easy loading of materials
- Complete backboard set for support and convenience
- 100% Manufactured in the UK

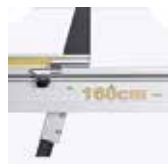

Telescopic legs adjustable for height to suit the operator & minimise fatigue



Permanent, ultra precise sight line strip

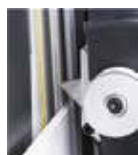

Single cut line for all tools for minimum fuss and maximum accuracy



Unique 5 cutter head with ready mounted integral tools

Excalibur Accessories and Blades:

| | | |
|---|------------|--------------|
| Freestanding kit - 122 - 48" | KCKX16 | \$515 |
| Freestanding kit - 160/200 - 63/78" | KCKX17 | \$515 |
| Sightline strip (pack of 3) | KCKX11 | \$91 |
| TW cutter head replacement | KCEXCOC | \$385 |
| Replacement wheels & bearings (TW cutter) | KCEXCOW | \$200 |
| Keencut 080 superior quality blades (100's) | CA50/010 | \$94 |
| TC Glass cutting wheel (5's) | KCCA50/015 | \$37 |
| Medium duty utility blades (100's) | KCA50/019 | \$48 |

EXCALIBUR 5000

Keencut EXCALIBUR is a unique cutting machine featuring two cutting heads combining to provide four cutting tools mounted for instant selection. Excalibur's integral counterbalance ensures an easy glide cutting action, prevents damage when loading sheet materials, minimizes operator fatigue and increases production. Excalibur 5000 is second only to the new Keencut SteelTraK and has more advanced features than any competitive vertical cutter. Keencut Excalibur has been continually upgraded since its introduction in 1996, making it ideal for applications where the high performance of the SteelTraK is not required.

With a cutting capacity of 163 cm, Keencut Excalibur 5000 is equipped to cut Glass 6mm - PVC Foamboard 13mm - Foamcore 13mm- Cardboard - Acrylic (Plexi) 6mm- Xanita 13mm - Polycarbonate - MDF 4mm - and much more without noise, dust or significant debris.

Outstanding features of the Excalibur



Turn & Lock ready mounted tools for instant action

All four blades cut on the same line. One stop setting - One measurement - One outline cursor - No special operator training - No laser shake - Less fatigue - No wasted panels - No mistakes

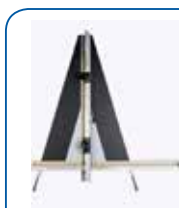

Complete backboard set for support and convenience

Complete set of vertical and horizontal scales (Imperial and Metric)

Top mounted screw adjusted permanent lock squaring arm



Full length extra-grip clamping system

Transparent outline cursor - renewable - fixed - ultra precise - no laser shake - no doubt and no wasted panels



Telescopic legs adjust for height & minimum fatigue

Simple Left & Right production stops - no need for fiddly colour coding



Universal turret cutting head with automatic blade disengagement at the end of cut

Fully equipped and ready for work with 100 blades included

Accepts standard utility blades

TWO SIZES AVAILABLE

KCEX500048 - 48" (Available on request)

KCEX500063 - 63"

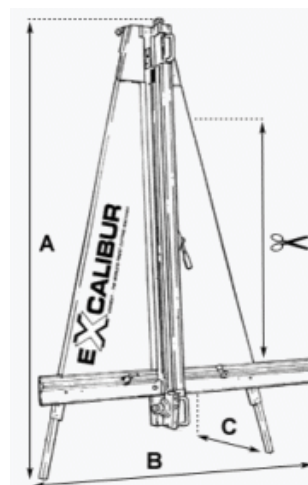

| | EXC5122 | EXC5160 & EXC1X |
|-------------------|-------------------|-------------------|
| Cut length cm (") | 122 (48) | 160 (63) |
| A cm (") | 208 (82) | 244 (96) |
| B cm (") | 213 (84) | 213 (84) |
| C cm (") | 30 - 40 (12 - 16) | 30 - 40 (12 - 16) |

KEENCUT
THE WORLD'S FINEST CUTTING MACHINES

TWO SIZES AVAILABLE

KCUL48 - 48"

KCUL62 - 62"

PRICE:POA

The Ultimate Matt Cutter KEENCUT Ultimat Gold



- 5 year guarantee
- Comfortable to use
- Tough, precise, built to last
- Comes complete- no extras to buy
- Unique roller "lift and hold" system raises or lowers the cutter bar
- Made in England

Unique patented micro stop adjusters fitted to the 'start of cut' 'end of cut' and 'margin guide' stops allows you to dial out overcuts or undercuts in seconds.

Precision cutting head, has sculpted shape for comfort with Ball and thrust bearings for continuous cutting accuracy. Twin blade head for bevel cutting as well as vertical cutting.

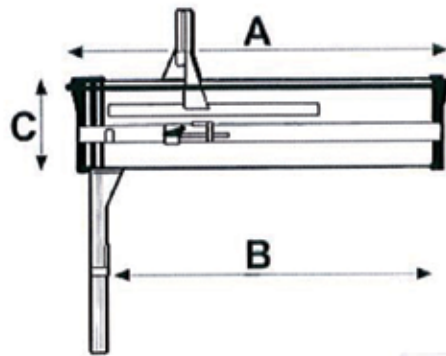

| | 1000 UG100 | 1200 UG120 | 1500 UG150 |
|----------|------------|------------|------------|
| A cm (") | 119 (47) | 139 (54.7) | 174 (68.5) |
| B cm (") | 101 (40) | 122 (48) | 157 (62) |
| C cm (") | | 39 (15.5) | |

Keencut Ultimat Gold is the most technically advanced, versatile and easy to use manual Mat Cutter in the world. Ultimat Gold is built to exacting standards and precision engineered to meet the requirements of the most skilled and creative picture framers year after year.

Keencut Ultimat Gold Bench Mounted Mat Cutter combines precision with durability; built to last and exceptionally comfortable to use. Ultimat Gold's integrated extra-wide baseboard with pre-installed grid markings is constructed from anodised aluminium, meaning it will not warp, bend or break over time. The Ultimat Gold Cutter Head is fully adjustable, ensuring no sideways play, and the unique and ingenious production stops guarantee that when used, there will be zero overcuts or undercuts.

Ultimat Gold is fully adaptable, accepting a range of readily available, easy-fit optional parts; making it the most versatile mat cutter in the world.

Outstanding features of the Ultimat Gold



The precision cutting head has a sculpted shape for comfort and features ball and thrust bearings for superb precision.

The bevel head has an ejector for quick blade changing and the vertical head can be locked in position to allow easy cutting of the thickest boards



Unique 'clip on' margin guide and squaring arm allows for easy removal when not in use; no tools required *maximum margin width is 19cm (7.5")



Unique roller 'lift and hold' system raises or lowers the cutter bar and frees both hands



75cm (30") clip on mat guide extension kit complete with 60cm support arms

Adjustable space age bearings and slideway feature a silent-glide action & 20 Year Guarantee



Unique sliding gauge pinpoints blade entry and exit spot for exact freehand cutting

Unique patented micro stop adjusters fitted to the 'start of cut,' 'end of cut' and 'margin guide' stops allow you to dial out overcuts or undercuts in seconds

Ultimat Gold Accessories and Blades:

| | |
|---|-------------|
| Keencut 080 superior quality blades (100's) | CA50-010 |
| Medium duty utility blades (100's) | KC CA50-019 |
| Tech D .012 blades | CA50-017 |
| Tech D .015 blades | CA50-021 |
| Tech S .012 blades | CA50-020 |
| Tech S .015 blades | CA50-030 |

| | |
|--|--------|
| 2 x Support arms, 60cm long | KCKX06 |
| 75cm ext. MG kit complete with 60cm arms | KCKX08 |
| Multi angle cutting gauge | KCKX09 |
| Reverse bevel stop | KCKX30 |
| Keencut ultimate wall mounting kit | KCKX10 |

Fletcher Matcutters



AVAILABLE IN TWO SIZES
F-220048" - 48"
F-220060" - 60"

PRICE: POA

Unique Performance Features

- Manual mat cutting for sizing cuts, cutting bevels and producing V-Grooves.
- Cuts 4-ply mat board
- Straight line cutting of foamboard up to 1/2" (13mm)
- Maximum material cutting thickness: 1/2" (13mm), 90° cut only
- Available machine sizes: 48" (1.2m) and 60" (1.5m)

Our Fletcher 2200 Mat Cutter provides specialty cutting for creating bevels & producing V-Grooves in matboard used for picture framing and art/graphics retail matting .

2200 Market Users

Picture Framing
 Government Agencies
 Digital Printers
 Photographers

2200 Purchase Package

- (1) 2200Mat Cutter
- (1) Sight Guide
- (2) Squaring Blocks
- (10) Mat Cutting Blades
- (10) Utility Blades



3100 Technical Specs CODE: F-3100 PRICE: POA

Cutting Head: Rides on high tensile strength steel, hard chrome plated and polished, resulting in smoother gliding action for consistent cutting head performance and longevity.

Vertical Bars: Rails do not bend or flex during the cutting process for straight, accurate cutting over the entire substrate height.

Material Clamping System: Patented lever-type clamping system that secures in place various substrate heights up to 63" (160cm) to prevent buckling and shifting of material during the cutting process.



Interchangeable Cutting Head Technology

Score & Break-out feature for glass & acrylic

Unique Performance Features F3100 Purchase Package-# 04-715

Interchangeable Cutting Head Technology
 Cuts clean debris-free no secondary processing
 Optional laser sight line for accurate cutting
 Mounts on wall or free-standing
 Cuts wide range of substrates

- (4) Pillar Posts
- Mat/Foamboard
- Plastic
- MDF
- Glass
- (10) Mat/Foamboard Blades
- (10) Plastic Blades
- (10) Steel 120° Glass Wheel Units
- (1) MDF Cutting Wheel Set
- (4) Wall Mounting Brackets
- (1) Manual

Wall Mounting Configuration

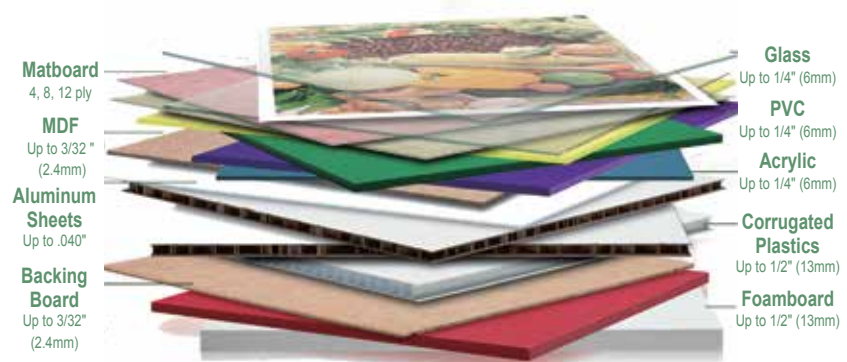
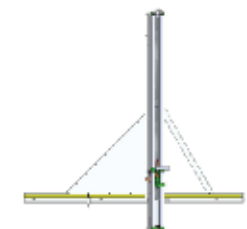

Matboard
4, 8, 12 ply

MDF
Up to 3/32" (2.4mm)

Aluminum Sheets
Up to .040"

Backing Board
Up to 3/32" (2.4mm)

Glass
Up to 1/4" (6mm)

PVC
Up to 1/4" (6mm)

Acrylic
Up to 1/4" (6mm)

Corrugated Plastics
Up to 1/2" (13mm)

Foamboard
Up to 1/2" (13mm)

3100 Market Users

Sign & Graphic
 Picture Framing
 Glass & Glazing
 Government Agencies
 Digital Printers

ULTIMAT FUTURA

UNIQUE, VERSATILE, EFFORTLESS

- Cutting head mounted on Roller Bearings, running on steel tracks for smooth, precise cutting
- Ergonomically designed to be suitable for left or right-handed users
- Designed to cut the latest and future mountboard
- Roller Lift & Hold system for one handed operation
- Easy to change blade cartridges



The Ultimat Futura: Unique versatility, advanced design and ultra precision manual matcutting to a new level of accurate, fast operation on modern matboards of every type and thickness. The Ultimat Futura matcutter features an all-new cutting head with built-in self aligning ball bearing rollers operating on twin steel tracks to deliver a sliding action that is smooth, precise and with no discernible friction under load. Maximum operator effort is transmitted to the blade to put the cutting of even 8ply mountboard within capability of every framer. Interchangeable magnetic blade holders on the Ultimat Futura make changing blades and holder for different depths of cut a simple, fast operation so necessary for the many different types of work that are processes in every busy framing workshop.

Features of the Ultimat Futura include the easy to use one-handed roller 'lift and hold' system, patented micro-stop adjuster, fitted to 'start the cut', 'end of cut' and 'margin guide' stops and uniquely designed baseplate to accept a range of readily available accessories. The new high performance slideway and head system has been designed in response to both the latest mountboard developments and those anticipated in the future. The introduction of the Ultimat Futura will not only maintain but greatly increase the Keencut world leadership in manual matcutter design.

All keencut products are 100% manufactured in the UK and the EU

UPGRADE KIT FOR ULTIMAT GOLD
KCUFRG120-120CM (48")
KCUFRG150-150CM (62")

KCUF120-120CM (48") PRICE: POA
KCUF150-150CM (62") PRICE: POA

Buy with confidence

All Keencut products are fully guaranteed for 5 years

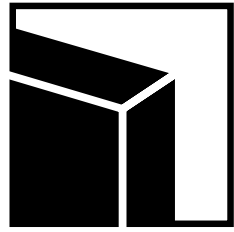

GALLERY

STRETCHER

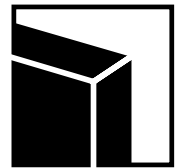

GALLERY

STRETCHER-150

CODE: CANSTRET150

PRICE: POA

Description:

Fully pneumatic canvas stretching machine that mounts to the side of a typical workbench to provide a seamless work surface. In this position the operator can easily manoeuvre the artwork, make folds in-place and apply staples from the front.

Physical Dimensions: 1524mm x 304.8mm x 82.55mm
Weight: 18.2 kg

Operating Parameters:

Max. Sized Artwork: 1524mm X 1524mm
Min. Excess Canvas: 38.1mm
Min. Stretcher Width: 19.05mm
Max. Stretcher Width: 63.5mm
Max. Supply Air: 8.2 bar
Min. Supply Air: 6.2 bar

Proposed Market:

The 150 model appeals to Commercial Printers, Custom Frame Shops, Print on Demand Services and to anyone with 66" wide inkjet printers and smaller.

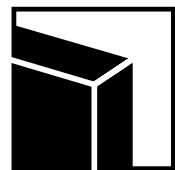

GALLERY

STRETCHER-240

CODE: CANSTRET240

PRICE: POA

Description:

Fully pneumatic canvas stretching machine that is designed to be mounted on the side of a typical workbench. This model is not easily transported and should be permanently installed. The 240 model shares the same basic features as the 150 model with one notable exception, the controls are located toward the center of the machine. An extra set of stretcher plates are included.

Physical Dimensions: 2438.4mm x 304.8mm x 82.55mm
Weight: 31.8kg

Operating Parameters:

Max. Sized Artwork: 2438.4mm X 2438.4mm
Min. Sized Artwork: 203.2mm X 254mm
Min. Excess Canvas: 38.1mm
Min. Stretcher Width: 19.05mm
Max. Stretcher Width: 63.5mm
Max. Supply Air: 8.2 bar
Min. Supply Air: 6.2 bar

Proposed Market:

The 240 model appeals to the graphic display houses, sign companies and anyone with the need to print over-sized art on canvas.





PRICE:POA



CUTTING & SCORING IS MORE EFFICIENT THAN EVER.

ECLIPSE™ AIRGLIDE

The **ECLIPSE™ AIRGLIDE** is ideal for use with 152 x 244cm sheets and features a 65" vertical capacity. Cutting and clamping mechanisms both operate on standard compressed air*.

The Eclipse™ AirGlide includes a Blade cartridge plus two speed settings for consistent quality with reduced fatigue. Both floor stand and wall mounting options are provided to fit your space. Optional Acrylic, Glass, and Composite cartridges are available to efficiently cut the variety of substrates you use most.

YOUR PURCHASE INCLUDES:

- ✓ **AIRGLIDE PNEUMATIC MATERIAL CUTTER**
▪ AirGlide Dimensions: 259cm Height x 250cm Width
- ✓ **FLOOR STAND & WALL MOUNT BRACKETS**
- ✓ **QUICK-CHANGE BLADE CARTRIDGE & HOLDER**
▪ Blade Cartridge + Box of 50 Blades
- ✓ **2-YEAR WARRANTY ON PMC PARTS**
- ✓ **MANUFACTURER TECHNICAL SUPPORT**

OPTIONAL ADD-ONS:

- AirGlide Acrylic Cartridge
- AirGlide Glass Cartridge
- AirGlide Composite Cartridge

| MATERIAL | THICKNESS | CARTRIDGE |
|--------------------|------------------------|-------------------|
| Matboard | up to 8 ply | Blade |
| Cardboard | up to 12.7mm (0.5") | Blade |
| Polystyrene | up to 12.7mm (0.5") | Blade |
| Foamboard | up to 12.7mm (0.5") | Blade |
| PVC Foamboard | up to 6.35mm (0.25") | Blade |
| Corrugated Plastic | up to 12.7mm (0.5") | Blade |
| Acrylic | up to 3.175mm (0.125") | Acrylic(option) |
| Glass | up to 6.35mm (0.25") | Glass(option) |
| Aluminum Composite | up to 3mm | Composite(option) |
| Aluminum Sheet | up to 1.016mm (0.04") | Composite(option) |

WIZARD CMC MODEL 9000

PRICE:POA



9000S & RETRACTABLE

9000 & FLOOR STAND

CMC MODEL 9000 features cutting speeds of up to 500mm per second, as well as our proprietary SwitchBlade™ technology for fast, easy blade and cartridge changes.

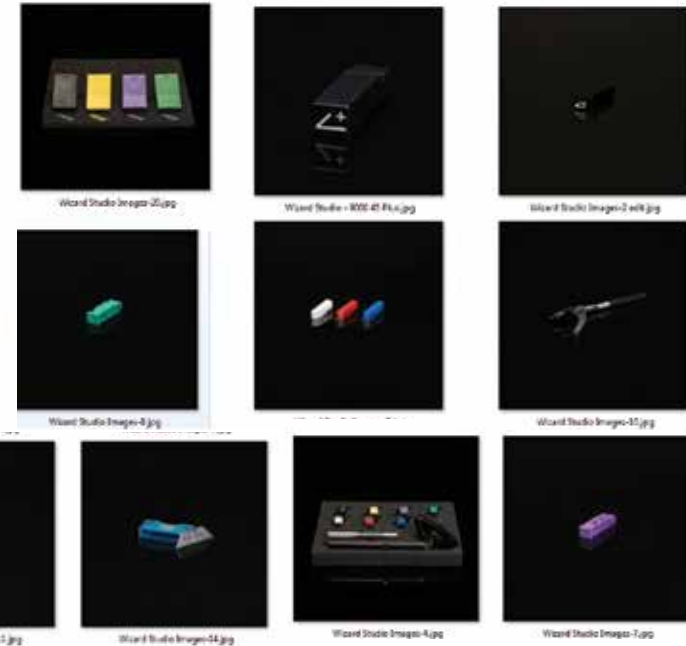

The CMC Model 9000, Wizard's top of the line mat cutting solution, features FrameShop™ Design software and offers four versatile bevel cartridges. Add on advanced design options like debossed lines, pen drawings, vinyl art, and custom box design to expand your creativity and bolster your business.

YOUR PURCHASE INCLUDES:

- ✓ **CMC MODEL 9000 (FULL SIZE) OR 9000S (SPACE-SAVER™)**
 - Fixed Wall Mount
- ✓ **SWITCHBLADE™ CARTRIDGES**
 - 45 Degree Metal Cartridge + Box of 45 Degree Premium Blades
 - 45+ Degree Metal Cartridge + Box of 45+ Degree Premium Blades
 - 52 Degree Cartridge + Box of 52 Degree Premium Blades
 - 90 Degree Cartridge + Box of 90 Degree Premium Blades
- ✓ **LENOVO® THINKCENTRE ALL-IN-ONE COMPUTER**
 - Intel® Pentium® Dual-Core CPU, 4GB RAM, 500GB HDD, DVD
 - Keyboard, Mouse & 20" Widescreen LED Monitor
 - Built-in Webcam, Speakers & Wi-Fi Capable
 - Windows® 10 Operating System
 - FrameShop™ Design Software*
- ✓ **PROFESSIONAL INSTALLATION & TRAINING†**
- ✓ **2-YEAR WARRANTY ON CMC PARTS**
- ✓ **1-YEAR WARRANTY ON COMPUTER**
- ✓ **UNLIMITED TECHNICAL SUPPORT**

OPTIONAL ADD-ONS:

- Pen Tool & User License**
- Debossing Cartridge Package & User License
- Vinyl Tool Starter Kit & User License**
- Box Design Kit & User Licenses**
- Retractable Wall Mount‡
- CMC Floor Stand
- Computer Stand
- Silentaire™ Super Silent DR-500 Air Compressor†

| code | description |
|--------------|---|
| WZ20-01105-1 | Navy blue box of 500 blades for CMC5000 (Eclipse) |
| WZ20-37010-2 | Black box of 100's premium blades 45 deg 8000, 8500 8500 e & 9000 |
| WZ20-37020-1 | yellow box of 100 premium blades 45+ deg |
| WZ20-37040-1 | green box of 50 premium blades 90 deg 8500sbt for CMC9000 |
| WZ30-30364-1 | air clamp hose assmbly for CMC8000 & CMC5000 & 85000 |
| WZ30-30474-1 | Black metal cartridge 45 deg for CMC9000 |
| WZ30-34030-1 | black cartridge 45 deg+ for CMC9000 |
| WZ30-34040-1 | yellow cartridge 45 deg plus plastic CMC 9000 |
| WZ30-34050-1 | green plastic cartridge 90 degree for CMC 9000 |
| WZ30-34072-1 | black metal cartridge 45 deg for CMC9000 |
| WZ20-31099-1 | Blue box of 500 blades for 8000,8500, 8500e & CMC9000 blades |
| WZ30-61045-1 | metal blade cartridge 45 degree for 8000 |
| WZ30-61013-1 | plastic blade cartidge 45 degree 8000-8500-8500e |

All prices are in U.S. Dollars and subject to change. FrameShop™ is a trademark of Wizard™ International, Inc.

*Internet connectivity is required to operate FrameShop™ software.

**Pen, Vinyl and Box Design User Licenses available only with FrameShop™ software.

†An air compressor (minimum 100 PSI) is required to operate Wizard™ CMCs.

‡ Retractable Wall Mount available for both CMC Models 9000 and 9000S.

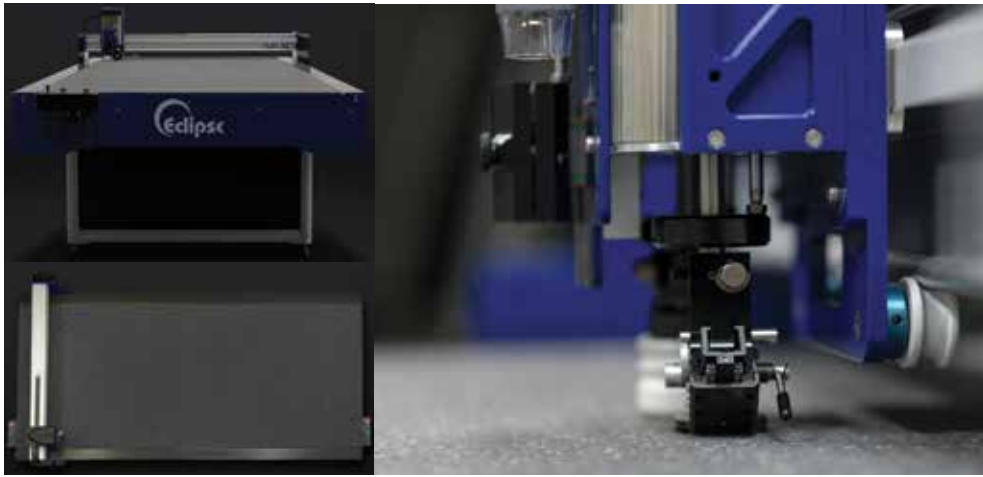

TECHNICAL SPECIFICATIONS

| | ECLIPSE™ FLEX XL |
|---|---|
| Physical Dimensions (L x W x H) | 70 x 124 x 50 in OR 178 x 315 x 127cm. |
| Maximum Cutting Area | 49 x 106.5 in OR 124 x 270cm. |
| Maximum Matboard Thickness | 8 Ply (3.5 mm) |
| Maximum Cut Depth | 45 Degree: 6mm. / 90 Degree: 9.5mm. |
| Maximum Cutting Speed | up to 1000mm. per second |
| Vacuum Board & Vacuum Pump Included | Yes |
| Dual Zone Capable | Yes |
| Material Waste | Zero |
| Interchangeable Tool System (Single Head, Multi-Tool) | Yes |
| Blade Depth Control | Digital |
| Complete Matboard Cut without Tool or Head Change | Yes |
| Single Blade for 45° & 90° Cutting | Yes |
| Automatic Change Between 45° & 90° Cutting Options | Yes |
| Power Supply | 230 V / 60Hz / 20A |
| Minimum Compressed Air Supply** | 90 PSI / 2 CFM (6 bar / 56 CLM) |
| CPU / Operating System | Intel® Core™ (4GB RAM, 500GB) / Windows® 10 |
| Nesting, Tiling & Stacked Mats | Yes |
| Opening Templates | Parametric: 113 / Custom: Unlimited |
| CutArt™ Designs | Premade: 3,000 / Custom: Unlimited |
| LetterMat™ Fonts | 15 |
| Included Single Line Fonts / System Fonts | 6 / 36+ |
| True Type Font Compatibility | Yes |
| File Type Support | DXF, JPG, XML, SVG, WZX, WZ2 |

ECLIPSE™ FLEX XL COMPUTERIZED MAT CUTTER

The Eclipse™ Flex XL has been engineered for high-volume cutting, debossing, custom packaging and more. With a vacuum board for edge-to-edge cutting with zero waste, dual-zone capability, single blade operation, and digital depth control through FrameShop™ software, it is the ultimate in efficiency and precision. Featuring an interchangeable tool system, the Flex XL switches automatically between 45 and 90 degree bevels without the need for tool or head changes. Effortlessly cut matboard, foamboard, cardboard, gatorboard and various other substrates. Our next generation computerized mat cutter is the ideal solution to increase productivity in your business.

Eclipse™ Flex XL

- ✓ Flex Computerized Mat Cutter
- ✓ Floor Stand & Vacuum Pump
- ✓ 45 Degree Metal Cartridge
- ✓ 90 Degree Cutting Tool
- ✓ Premium Double-Honed Blades

OPTIONAL ADD-ONS (\$):

- Debossing Cartridge Package
- Box Design Kit

Customer Support

- ✓ Free Shipping†
- ✓ Professional Installation & Training†
- ✓ 1-year Warranty on Computer
- ✓ 2-year Warranty on CMC Parts
- ✓ Technical Support

OPTIONAL ADD-ON (\$):

- Extended Warranty

Computer & Software

LENOVO® ALL-IN-ONE COMPUTER:

- ✓ 4GB RAM, 500GB HDD, DVD
- ✓ 20" Widescreen LED Monitor
- ✓ Full-size Keyboard & Mouse
- ✓ Built-in Webcam, Speakers & Mic
- ✓ Built-in Wi-Fi Adapter
- ✓ Windows® 10 Operating System
- ✓ FrameShop™ Design Software*
- ✓ Adjustable Computer Stand



FrameShop™ and Eclipse™ are trademarks of Wizard International, Inc.
 *Internet connectivity is required to operate FrameShop™ software.
 **An air compressor (min. 90 PSI, 2 CFM) is required for CMC operation.

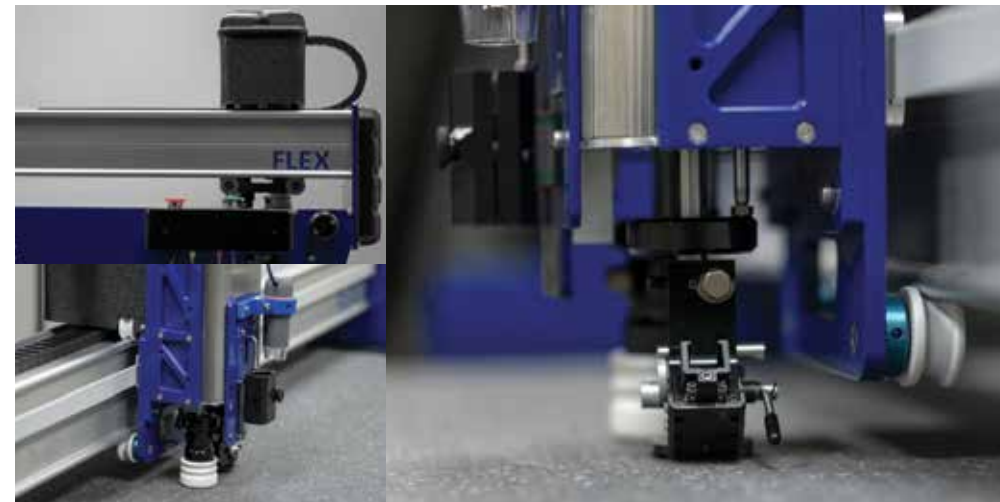

ECLIPSE™ FLEX COMPUTERIZED MAT CUTTER

The Eclipse™ Flex has been engineered for high-volume cutting, debossing, custom packaging and more. With a self-healing vacuum board for edge-to-edge cutting with zero material waste, single blade operation, and digital depth control through FrameShop™ software, it is the ultimate in efficiency and precision. Featuring an interchangeable tool system, the Flex switches automatically between 45 and 90 degree bevels without the need for tool or head changes. Effortlessly cut matboard, foamboard, cardboard, gatorboard and various other substrates. Our next generation computerized mat cutter is the ideal solution to increase productivity in your business.

Eclipse™ Flex

- ✓ Flex Computerized Mat Cutter
- ✓ Floor Stand & Vacuum Pump
- ✓ 45 Degree Metal Cartridge
- ✓ 90 Degree Cutting Tool
- ✓ Premium Double-Honed Blades

Optional Add-Ons (\$):

- Debossing Cartridge Package
- Box Design Kit

Customer Support

- ✓ Free Shipping†
- ✓ Professional Installation & Training†
- ✓ 1-year Warranty on Computer
- ✓ 2-year Warranty on CMC Parts
- ✓ Technical Support

Computer & Software

LENOVO® ALL-IN-ONE COMPUTER:

- ✓ 4GB RAM, 500GB HDD, DVD
- ✓ 20" Widescreen LED Monitor
- ✓ Full-size Keyboard & Mouse
- ✓ Built-in Webcam, Speakers & Mic
- ✓ Built-in Wi-Fi Adapter
- ✓ Windows® 10 Operating System
- ✓ FrameShop™ Design Software*
- ✓ Adjustable Computer Stand

TECHNICAL SPECIFICATIONS

| | ECLIPSE™ FLEX |
|---|---|
| Physical Dimensions (L x W x H) | 66 x 87 x 50 in OR 167.5 x 221 x 127cm. |
| Maximum Cutting Area | 44 x 65.5 in OR 112 x 166cm. |
| Maximum Matboard Thickness | 8 Ply (3.5 mm) |
| Maximum Cut Depth | 45 Degree: 6mm. / 90 Degree: 9.5mm. |
| Maximum Cutting Speed | up to 1000mm. per second |
| Vacuum Board & Vacuum Pump Included | Yes |
| Dual Zone Capable | No |
| Material Waste | Zero |
| Interchangeable Tool System (Single Head, Multi-Tool) | Yes |
| Blade Depth Control | Digital |
| Complete Matboard Cut without Tool or Head Change | Yes |
| Single Blade for 45° & 90° Cutting | Yes |
| Automatic Change Between 45° & 90° Cutting Options | Yes |
| Power Supply | 230 V / 60Hz / 20A |
| Minimum Compressed Air Supply** | 90 PSI / 2 CFM (6 bar / 56 CLM) |
| CPU / Operating System | Intel® Core™ (4GB RAM, 500GB) / Windows® 10 |
| Nesting, Tiling & Stacked Mats | Yes |
| Opening Templates | Parametric: 113 / Custom: Unlimited |
| CutArt™ Designs | Premade: 3,000 / Custom: Unlimited |
| LetterMat™ Fonts | 15 |
| Included Single Line Fonts / System Fonts | 6 / 36+ |
| True Type Font Compatibility | Yes |
| File Type Support | DXF, JPG, XML, SVG, WZX, WZ2 |



FrameShop™ and Eclipse™ are trademarks of Wizard International, Inc.
 *Internet connectivity is required to operate FrameShop™ software.
 **An air compressor (min. 90 PSI, 2 CFM) is required for CMC operation.

The cutting edge in matcutting

Zund mount cutting systems are utilized throughout the custom framing and production sections of the industry. Mount Maker software, features standard design and rectangle/oval mounts, to free-form design of shapes including scanned images, through to nesting on the mount board for maximum yield.

With the ability to cut mount board up to a maximum of 5mm thickness the Zund standard tooling includes straight (trim) cutting, true 45 degree bevel cutting, v-grooving and a pen insert for key lines, text and general mount decoration.

Add a creasing tool and presentation boxes or corner protectors can be designed and cut on the Zund mount cutter. Oscillating tools can be utilised for foam core mounts to the thickness of 10mm.

Additional possibilities of camera recognition systems for cutting re-printed mount board in perfect registration for that unique coloured, patterned, text or corporate logo mount. Can be retrofitted, thus illustrating the modular, flexible approach of the Zund cutting system.

Available in these popular sizes

M800 : 1300mm x 800mm

M1600 : 1600mm x 1330mm

G32XL1600 : 2740mm x 1600mm

PRICE: POA

Print Mounting and Lamination



AMOPTHER

NEW!! Press Temperature Thermometer

A hand-held thermometer used to accurately measure the temperature of your press or laminator.



AMOPER

NEW!! Press Roll Cleaner

This rubber-based erasure is useful for cleaning and removing tough residue left on the press rollers from general use.



AMOPKIT

AMS Cleaning Kit for Lamination and Mounting Presses

This system is for Cleaning your Proseal, Roller Mounters and Laminators. The outer sides of the machine may be cleaned with a lint free cloth, lightly dampened with a mild soap and water solution. Do not use spray-on cleaners. Do not immerse any part of the machine in water or other liquids. Clean the Rollers with Poly-Off Cleaners & Erasure as follows:

1. Remove Poly-Off kit from Packaging.
2. Place Latex gloves over hands for protection.
3. Apply to warm rollers NOT HOT!!
4. Pour required amount of Poly-Off to sponge and/or abrasive brush.
5. Scrub affected area until all debris has loosened.
6. Wipe clean with towel or cloth material.
7. Place Poly-Off kit back in packaging for storage.

AMOPKIT Cleaning Kit for Lamination and Mounting Presses

Films & Laminates

| Code | Description |
|------------|--|
| AM2-150245 | New tech perm mounting tissue 150'x 24.5" |
| AM2-150405 | New tech per mounting tissue 150' x40.5" |
| AM2-300245 | New tech perm mounting tissue 300' x 24.5" |
| AM2-300405 | New tech perm mounting tissue 300' x 40.5" |
| AM7-150245 | Ez- Mount permanent tissue 150' x 40.5" |
| AM7-150405 | Ez- Mount permanent tissue 300' x 24.5" |
| AM7-300405 | Ez- Mount permanent tissue 300' x 40.5" |
| AM14-23B | Canvas psa heat assist & linerole ss-5mil vinyl laminate |
| AM17-238 | Superstick canvas 10 ml |

AMS KOOL Cold Roller Lamination and Mounting Press

AMS is pleased to introduce the next generation model cold roller lamination and mounting press. A single operator can easily mount and laminate artwork with this press. The new KOOL cold laminator is inexpensive while providing the essential features found on more expensive models including:

- Top and bottom nip rollers covered with hard silicone
- Rigid steel cores in top roller for better pressure
- Heavy-duty motor
- Automatic take-up shaft
- Spring-loaded top roller
- Rugged steel and aluminum construction
- Accommodates boards up to 1/2" (1.3 cm) thick (can be made for 1" (2.5 cm) thick boards upon request)
- Available widths: 25" (63.5 cm), 38" (96.5 cm), 55" (139.7 cm) and 65" (165.1 cm)
- OEM product that is manufactured in the U.S.A

Optional stand and footswitch for hands-free control available.

With the AMS KOOL press, you can laminate media from long wraps down to smaller inkjet photos.

Even if you are using solvent or archival inks, laminating offers important benefits.

- Provides scratch resistance and UV protection
- protects from chemicals, dirt and fingerprints
- keeps your print looking great during its entire life
- extends the life of the print
- Prints look more vibrant
- Cold laminated have excellent clarity
- Variety of finishes-gloss, luster, matte



Machine can be placed on workspace table or on our stand.



Optional Stand has four castors providing mobility and saving table space.

Description

25-inch (63.5 cm) Cold Roller Lamination and Mounting Press
 38-inch (96.5 cm) Cold Roller Lamination and Mounting Press
 55-inch (139.7 cm) Cold Roller Lamination and Mounting Press
 65-inch (165.1 cm) Cold Roller Lamination and Mounting Press
 Optional Footswitch for hands-free control
 Optional Stand with 4 castors for mobility

Code

KOOL25
 KOOL38-2
 KOOL55
 KOOL65
 KOOLFS
 KOOLSTAND

AMS 42-inch Heavy-duty Professional Heated Roller Lamination and Mounting Press

This heavy-duty, industrial-strength lamination and mounting machine seals and/or laminates wide format print. It is designed for "all-in-one" laminating and is ideal for wide-format digital output. This machine would be a perfect fit in quick print shops, graphics houses, service bureaus and more.

Acceptable films for this machine are made of polyester, polypropylene and nylon. It is designed for mounting and laminating low temperature and thermal films. Turn off the heat function when using pressure-sensitive films. For heated sealing, please see our assortment of heat-assist laminates and dry mounting tissue. For cold pressure sealing with heat function turned off, please see our assortment of cold lamination and mounting films.



Speed Control & FWD/REV



Temperature Control



Nip & Pull Roller Adjustment

Easy to use

- Mounter, Laminator, Encapsulator
- Fast set-up and easy operation
- Roller Lift for easy film loading
- In-line slitter for trimming during lamination (optional)
- Variable roller pressure
- Accepts low-melt, thermal and pressure sensitive films
- Accommodates substrates up to a 1/2" (.064mm) thick
- Release liner rewind (optional)

Heavy Duty

- Designed for mounting and laminating low-temp, thermal and pressure sensitive films
- Heated rollers for a variety of films
- Heavy-duty forward/reverse variable speed motor
- Sturdy feed-back table with adjustable feed guide
- Heavy-duty top grade silicone rubber rollers
- Heavy-duty chain sprocket drive
- Four high-capacity forced air cooling fans

Operator-friendly

- "Ready" and "wait" lights indicate when the laminator has reached preset temperatures
- Independent upper and lower electronic temperature controls with LED displays
- Spring-loaded adjustable pressure on laminating and pull rollers for smooth, even lamination
- Foot switch allows hands-free operation for guided materials during lamination (optional)
- Auto grip shafts

Applications

- Ink jet prints
- Floor graphics and POP displays
- Signs and trade show applications
- Mouse pads
- Counter mats
- Book covers, dust jackets, yearbooks
- Calendars
- Menus
- Pictures
- Maps
- and much more!

Technical Specifications

Working Width: 41 inches (104.14cm)
 Laminator Width: 57 inches (144.78cm)
 Height: 19 1/4 inches (48.9cm)
 Depth (with feed tray): 27 1/2 inches (69.22cm)
 Net Weight: 205 lbs. (93kg)
 Shipping Weight: 255 lbs. (116kg)
 Speed: 0-10 fpm
 Electrical Requirements: 230V 30A
 Maximum Temperature: 300° F (149.9° C)
 Maximum Aperature: 1/2 inch (0.64cm)
 Roller Diameter: 3 inches (7.62cm)

Description

AMS 42-inch Heavy-duty Professional Lamination and Mounting Press
 Slitter Kit (Optional)
 Foot Pedal (Optional)
 Take-Up Reel (Optional)

Code

AM42PRO1
 AM42SLITKT
 AM42FOOTPED
 AM42PTREEL



COLD GLUE MACHINE

ABOUT THE SYSTEM

Combines motorized roller coaters, or a hand applicator with a unique adhesive. Provides the following benefits:

- Rolls on a microthin coating
- Fast-coats at 12 seconds per metre
- Stays repositionable for up to two minutes
- Bond will not be effected by heat, humidity or aging
- Cuts costs-adhesive cost only 4 cents per sq ft

| Code | Description |
|--------|--|
| M2402X | 24.5 inch (61.25cm) Glue Machine with Plastic Coating-240 volt |
| M3602X | 36.5 inches (91.25 cm) Glue Machine - 240 volt |
| G128S2 | 5 litre glue for glue machine cold roller glue applications |

Adhesive:

Made from a unique formula and provides the following benefits:

- Smooth, even coating
- Strongest adhesion possible
- Will not yellow over time
- Acid free, non toxic
- Stays fresh in coasters for a long time eliminating daily clean-up

Note: one surface must be porous to get a permanent bond i.e photo paper (no porous) can be mounted to foamboard, mat board, paper, cardboard etc which are all porous surface, but not to plastic. If you are mounting a print with a porous and non porous surfaces including plastic, wood and metal.

GREAT FOR:

- Mounting photos posters & artwork
- Making jigsaw puzzles
- Adhering labels
- Making custom greeting cards & invitations

HOT GLUE MACHINE



| Code | Description |
|---------|---|
| MX362 | 24.5 inch (61.25cm) Glue Machine with Plastic Casing - 240 volt |
| MXG11-7 | One refill cello bags for glue machine |

Glue Roller Machines are built from steel and aluminium with a heavy-duty motor designed for continuous use. First, run print through glue roller machine to apply glue. Next, lay print onto board as desired and smooth. Lastly, run print on board together through the pressure roller secure adhesion.

ABOUT THE SYSTEM

GREAT FOR MOUNTING:

- Wide format inkjet prints to boards (displays, posters, signage)
- Fine art prints
- Photos
- Presentations
- Photo albums
- Puzzles and board games
- Book covers
- Labels
- Trading cards

- Suitable for custom framing as well as production
- Combines motorized roller coaters with unique hot melt adhesive which provides the following benefits:
 - Strongest bond possible
 - Sticks permanently to just about any surface including plastic, wood and metal
 - Glue is repositionable for five minutes after gluing therefore avoids costly mistakes
 - Costs only 4 cents per sq. ft
 - Applies a very thin, smooth coating (absolutely no bumps)
 - Motorized roller coaters apply the coating at 12 seconds per metre
 - Adhesive coating will not lose its tack, so you can mount at any time
 - Non toxic and non hazardous
 - Adhesive will not transfer to your fingers so it is clean to work with
 - Coaters require no maintenance. Just turn off power and you are done

WORKSTATION

Production workstation are the new benchmark in ergonomic design and function. It makes sense to have all your tools in easy reach but eliminates a cluttered benchtop.

Made entirely in the USA from the highest quality. Each stand can be tailor made to your specifications

Please note: air-tools, hoses and counter balances are sold separately.

Start up kit

- 2 cast legs
- 2 aluminium uprights 1.2m long
- 1 aluminium top rail 2.4m with air fittings
- 5 runners and 5 carabine hooks

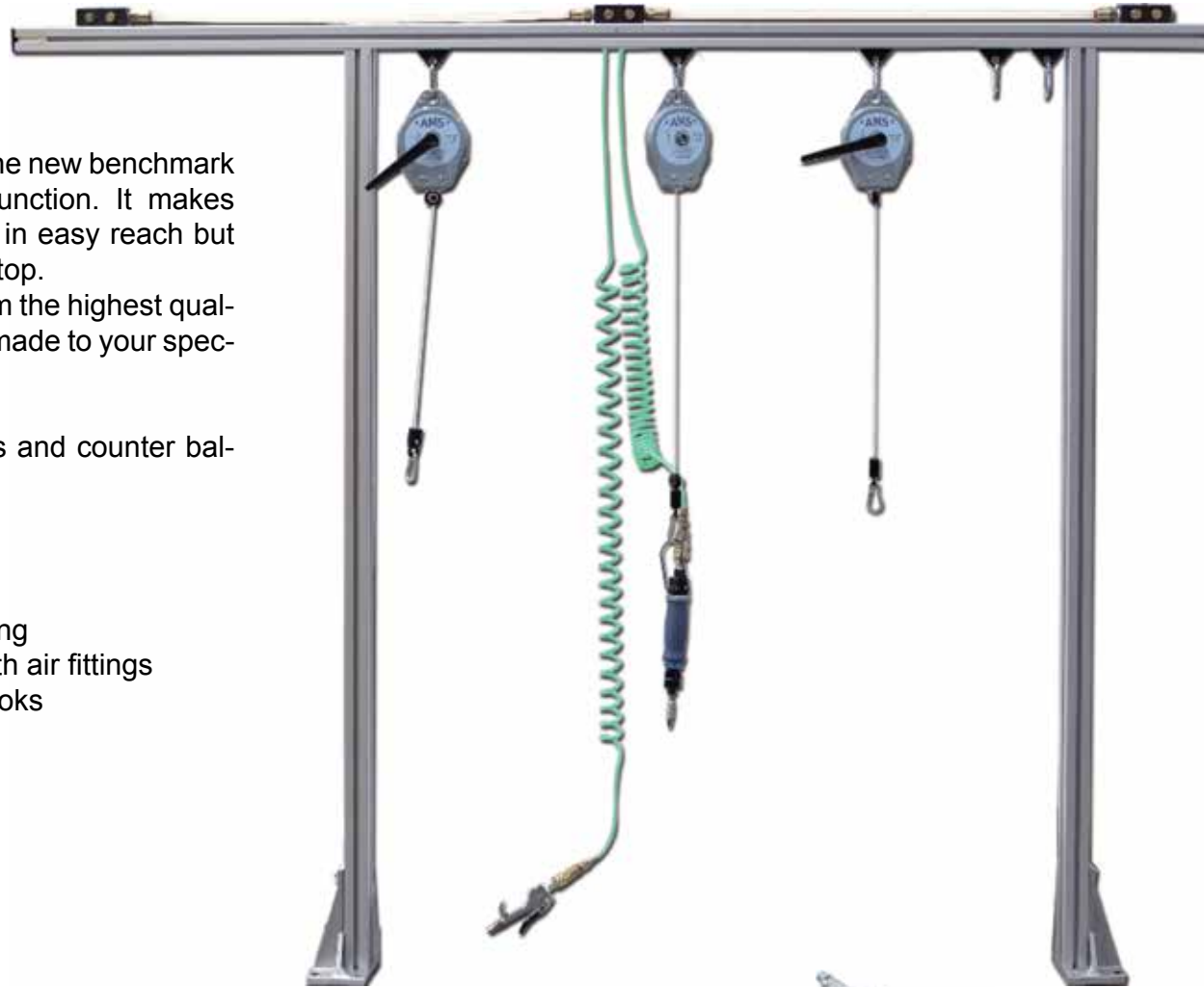

Only the highest quality air fitting and connectors are used throughout.



Strong cast alloy legs to either clamp or bolt the workstation securely to your bench.



Ultra smooth runners with strong carabine fittings.



Work Station Accessories

Torque Driver is the most advanced air driver on the market. Having a push to start trigger allows one hand operations with adjustable torque stops for precise setting of screws. Ruggedly constructed for years of trouble free service. Now with a speciality modified torque speed specifically for working with picture frames
Code: 93PSD45



Counter Balances, If you've ever wanted to have your tool within arms reach without cluttering up your work station then we have the solution. These counter balancer allows you to retract your tools overhead. Each balancers hanging weight can be adjusted to suit the tool weight. Currently stocking 1-2kg weight range with weight ranges 2-4kg or 3-6kg are available by special order.
Code: 93B045



Flexcoil Polyurethane Air Hose (Self Storing) cannot be kinked or scraped. This lightweight, yet durable hose will withstand the roigors while maintaining its resiliency over a long period of time. Swivel fitting is provided with thread seal.
Code: GREEN HOSE



Air Dusters. Tough all metal design that ergonomically fits the palm of your hand for precise control
Code: 9360B



11-SLEEVE Slotted power bit with finder sleeve



BIT2XS 1/4 inch hex phillips bit #2 Short



MAG-HD Premium magnetic bit holder, one piece stainless steel.

SPEEDVAC 'COLD MOUNT' VACUUM PRESS

Made in
AUSTRALIA



CODE: VP6040
64" x 44" press including pump

Optional extras
VPstand to suit 64' x 44' press

Vacuum pump:
1/3 HP 4CFM oil pump.

VACUUM PUMP 1/3 HP
4 CFM LONG NOSE
OIL PUMP TW-2A



VACUUM PUMP

The Speedvac vacuum press has been engineered and manufactured to provide years of constant and reliable operation. Each feature and component has undergone meticulous performance evaluation and field trials to refine a product of excellence. Using our vacuum pump the Speedvac is capable of attaining an evenly distributed pressure of 2200lbs over a 13" x 13" board. Varied sizes of vacuum presses can be made to order.

Controls

On/Off pump power supply switch
Adjustable process time control
(Range 10 sec ... 10 mm)
Vacuum release valve
Vacuum Gauge

SPECS:
62" 42" Internal
66" 46" External
5 3/8" Overall Depth

Features

Welding steel base chassis lid
High tensile hinges well secured
Gas operated springs fitted for
well balanced lid operation
Blanket made from neoprene
6mm Glass fitted to glass Power
coated long life surface finish All
controls surface mounted on front
panel Special ventlon felt panel
to enhance performance Blanket
mounted on separate removable
chassis for easy servicing

Epson & Canon Media

We have available two types of media for Epson & Canon wide format printers.

*260 gsm satin 44" wide (111cm) 30mt per roll
Code: ROLL 111-30M-

*260gsm matte finish (150cm) 30 meters long
Code: ROLL 150-30M



The Expression® line of vacuum presses from D&K offers guaranteed quality results every time for mounting, laminating, and texturing projects. Vacuum presses allow users to simultaneously process multiple pieces of artwork with varying sizes and thicknesses. The 4468H Vacuum Press is the preferred choice for framing professionals with user-friendly touch pad controls with six factory-installed programs for processing common applications. The 4468H Vacuum Press also includes an Expression® cutting mat that allows you to use the top of the press as a working surface.

PRICE POA

Features Code: HVP4468

- Touch-pad controls.
- Easy to read digital display.
- Programmable system controller with six preset programs.
- End-of-cycle signal.
- Space-saving work surface.
- Maintenance-free vacuum pump.

Features

- Working Capacity: 112cm x 173cm x 2.5cm
- Dimensions: 183cm x 144cm x 17cm
- Net Weight: 93kg
- Shipping Weight: 327kg
- Power: 240V AC, 15 Amps
- Electrical Requirements: 4-wire, single phase NEMA L14-20 plug
- Pressure: 13 psi
- Floor Stand: Optional – 19kg



MADE IN USA

The Expression® line of vacuum presses from D&K offers guaranteed quality results every time for mounting, laminating, and texturing projects. Vacuum presses allow users to simultaneously process multiple pieces of artwork with varying sizes and thicknesses. The 5298H Vacuum Press includes a built-in stand and user-friendly touch pad controls with six factory-installed programs for processing common applications. The 5298H Vacuum Press also includes an Expression® cutting mat that allows you to use the top of the press as a working surface.

PRICE POA

Features Code: HVP5298

- Built-in stand.
- Touch-pad controls.
- Easy to read digital display.
- Programmable system controller with six preset programs.
- End-of-cycle signal.
- Space-saving work surface.
- Maintenance-free vacuum pump.

Features

- Working Capacity: 122cm x 244cm x 2.5cm
- Dimensions: 272cm x 165cm x 94
- Net Weight: 170kg
- Shipping Weight: 500kg
- Power: 240V AC, 26 Amps
- Electrical Requirements: 4-wire, single phase NEMA L14-30 plug
- Pressure: 13 psi
- Floor Stand: Built-in





WV1 BUTTERNUT
20.5W x 60H x 14.5RH x 7RW
Box Quantity "104.4mts"
PCU: 39



WV1 IRONBARK
20.5W x 60H x 14.5RH x 7RW
Box Quantity "104.4mts"
PCU: 39



WV1 ARSENIC
20.5W x 60H x 14.5RH x 7RW
Box Quantity "104.4mts"
PCU: 39



WV1 MERABAU
20.5W x 60H x 14.5RH x 7RW
Box Quantity "104.4mts"
PCU: 39



WV1 OYSTER
20.5W x 60H x 14.5RH x 7RW
Box Quantity "104.4mts"
PCU: 39



WV1 PURE WHITE
20.5W x 60H x 14.5RH x 7RW
Box Quantity "104.4mts"
PCU: 39



WV1 SMOKE
20.5W x 60H x 14.5RH x 7RW
Box Quantity "104.4mts"
PCU: 39



WV1 STORM
20.5W x 60H x 14.5RH x 7RW
Box Quantity "104.4mts"
PCU: 39



WV1 STRAW
20.5W x 60H x 14.5RH x 7RW
Box Quantity "104.4mts"
PCU: 39



WV1 WHITEOAK
20.5W x 60H x 14.5RH x 7RW
Box Quantity "104.4mts"
PCU: 39



WV1 CHESTNUT
20.5W x 60H x 14.5RH x 7RW
Box Quantity "104.4mts"
PCU: 39



WV2 BUTTERNUT
20.5W x 40H x 14.5RH x 6RW
Box Quantity "130.5mts"
PCU: 21



WV2 IRONBARK
20.5W x 40H x 14.5RH x 6RW
Box Quantity "130.5mts"
PCU: 21



WV2 ARSENIC
20.5W x 40H x 14.5RH x 6RW
Box Quantity "130.5mts"
PCU: 21



WV2 MERABAU
20.5W x 40H x 14.5RH x 6RW
Box Quantity "130.5mts"
PCU: 21



WV2 OYSTER
20.5W x 40H x 14.5RH x 6RW
Box Quantity "130.5mts"
PCU: 21



WV2 PURE WHITE
20.5W x 40H x 14.5RH x 6RW
Box Quantity "130.5mts"
PCU: 21



WV2 SMOKE
20.5W x 40H x 14.5RH x 6RW
Box Quantity "130.5mts"
PCU: 21



WV2 STORM
20.5W x 40H x 14.5RH x 6RW
Box Quantity "130.5mts"
PCU: 21



WV2 STRAW
20.5W x 40H x 14.5RH x 6RW
Box Quantity "130.5mts"
PCU: 21



WV2 WHITEOAK
20.5W x 40H x 14.5RH x 6RW
Box Quantity "130.5mts"
PCU: 21



WV2 CHESTNUT
20.5W x 40H x 14.5RH x 6RW
Box Quantity "130.5mts"
PCU: 21



WV3 BUTTERNUT
60W x 22H x 11.5RH x 7RW
Box Quantity "87mts"
PCU: 39



WV3 IRONBARK
60W x 22H x 11.5RH x 7RW
Box Quantity "87mts"
PCU: 39



WV3 ARSENIC
60W x 22H x 11.5RH x 7RW
Box Quantity "87mts"
PCU: 39



WV3 MERABAU
60W x 22H x 11.5RH x 7RW
Box Quantity "87mts"
PCU: 39



WV3 OYSTER
60W x 22H x 11.5RH x 7RW
Box Quantity "87mts"
PCU: 39



WV3 PURE WHITE
60W x 22H x 11.5RH x 7RW
Box Quantity "87mts"
PCU: 39



WV3 SMOKE
60W x 22H x 11.5RH x 7RW
Box Quantity "87mts"
PCU: 39



WV3 STORM
60W x 22H x 11.5RH x 7RW
Box Quantity "87mts"
PCU: 39

• APM Australian Made



WV3 STRAW
60W x 22H x 11.5RH x 7RW
Box Quantity "87mts"
PCU: 39



WV3 WHITEOAK
60W x 22H x 11.5RH x 7RW
Box Quantity "87mts"
PCU: 39



WV3 CHESTNUT
60W x 22H x 11.5RH x 7RW
Box Quantity "87mts"
PCU: 39



WV4 BUTTERNUT
40W x 22H x 11.5RH x 7RW
Box Quantity "87mts"
PCU: 26



WV4 IRONBARK
40W x 22H x 11.5RH x 7RW
Box Quantity "87mts"
PCU: 26



WV4 ARSENIC
40W x 22H x 11.5RH x 7RW
Box Quantity "87mts"
PCU: 26



WV4 MERABAU
40W x 22H x 11.5RH x 7RW
Box Quantity "87mts"
PCU: 26



WV4 OYSTER
40W x 22H x 11.5RH x 7RW
Box Quantity "87mts"
PCU: 26



WV4 PURE WHITE
40W x 22H x 11.5RH x 7RW
Box Quantity "87mts"
PCU: 26



WV4 SMOKE
40W x 22H x 11.5RH x 7RW
Box Quantity "87mts"
PCU: 26



WV4 STORM
40W x 22H x 11.5RH x 7RW
Box Quantity "87mts"
PCU: 26



WV4 STRAW
40W x 22H x 11.5RH x 7RW
Box Quantity "87mts"
PCU: 26



WV4 WHITEOAK
40W x 22H x 11.5RH x 7RW
Box Quantity "87mts"
PCU: 26



WV4 CHESTNUT
40W x 22H x 11.5RH x 7RW
Box Quantity "87mts"
PCU: 26



WV5 BUTTERNUT
20W x 40.5H x 34RH x 7RW
Box Quantity "156.6mts"
PCU: 20



WV5 IRONBARK
20W x 40.5H x 34RH x 7RW
Box Quantity "156.6mts"
PCU: 20



WV5 ARSENIC
20W x 40.5H x 34RH x 7RW
Box Quantity "156.6mts"
PCU: 20



WV5 MERABAU
20W x 40.5H x 34RH x 7RW
Box Quantity "156.6mts"
PCU: 20



WV5 OYSTER
20W x 40.5H x 34RH x 7RW
Box Quantity "156.6mts"
PCU: 20



WV5 PURE WHITE
20W x 40.5H x 34RH x 7RW
Box Quantity "156.6mts"
PCU: 20



WV5 SMOKE
20W x 40.5H x 34RH x 7RW
Box Quantity "156.6mts"
PCU: 20



WV5 STORM
20W x 40.5H x 34RH x 7RW
Box Quantity "156.6mts"
PCU: 20



WV5 STRAW
20W x 40.5H x 34RH x 7RW
Box Quantity "156.6mts"
PCU: 20



WV5 WHITEOAK
20W x 40.5H x 34RH x 7RW
Box Quantity "156.6mts"
PCU: 20



WV5 CHESTNUT
20W x 40.5H x 34RH x 7RW
Box Quantity "156.6mts"
PCU: 20



WV6 BUTTERNUT
31.5W x 19.5H x 12.5RH x 7RW
Box Quantity "126.7mts"
PCU: 16



WV6 IRONBARK
31.5W x 19.5H x 12.5RH x 7RW
Box Quantity "126.7mts"
PCU: 16



WV6 ARSENIC
31.5W x 19.5H x 12.5RH x 7RW
Box Quantity "126.7mts"
PCU: 16



WV6 MERABAU
31.5W x 19.5H x 12.5RH x 7RW
Box Quantity "126.7mts"
PCU: 16



WV6 OYSTER
31.5W x 19.5H x 12.5RH x 7RW
Box Quantity "126.7mts"
PCU: 16



WV6 PURE WHITE
31.5W x 19.5H x 12.5RH x 7RW
Box Quantity "126.7mts"
PCU: 16



WV6 SMOKE
31.5W x 19.5H x 12.5RH x 7RW
Box Quantity "126.7mts"
PCU: 16



WV6 STORM
31.5W x 19.5H x 12.5RH x 7RW
Box Quantity "126.7mts"
PCU: 16



WV6 STRAW
31.5W x 19.5H x 12.5RH x 7RW
Box Quantity "126.7mts"
PCU: 16



WV6 WHITEOAK
31.5W x 19.5H x 12.5RH x 7RW
Box Quantity "126.7mts"
PCU: 16



WV6 CHESTNUT
31.5W x 19.5H x 12.5RH x 7RW
Box Quantity "126.7mts"
PCU: 16



WV7 BUTTERNUT
46W x 55H x 44RH x 35RW
Box Quantity "69.6mts"
PCU: 42



WV7 IRONBARK
46W x 55H x 44RH x 35RW
Box Quantity "69.6mts"
PCU: 42



WV7 ARSENIC
46W x 55H x 44RH x 35RW
Box Quantity "69.6mts"
PCU: 42



WV7 MERABAU
46W x 55H x 44RH x 35RW
Box Quantity "69.6mts"
PCU: 42



WV7 OYSTER
46W x 55H x 44RH x 35RW
Box Quantity "69.6mts"
PCU: 42



WV7 PURE WHITE
46W x 55H x 44RH x 35RW
Box Quantity "69.6mts"
PCU: 42



WV7 SMOKE
46W x 55H x 44RH x 35RW
Box Quantity "69.6mts"
PCU: 42



WV7 STORM
46W x 55H x 44RH x 35RW
Box Quantity "69.6mts"
PCU: 42



WV7 WHITEOAK
46W x 55H x 44RH x 35RW
Box Quantity "69.6mts"
PCU: 42



WV7 CHESTNUT
46W x 55H x 44RH x 35RW
Box Quantity "69.6mts"
PCU: 42

EVERYDAY BLACK



MG 2040 MB
20W x 40H x 35RH x 6.8RW
Box Quantity "92mts"
PCU : 17



GL 2040 MBT
19W x 40H x 35RH x 6.8RW
Box Quantity "113mts"
PCU : 24



CB 2040 MB
20W x 40H x 35RH x 6.8RW
Box Quantity "113mts"
Budget
PCU : 17



CB 20MB
20W x 21H x 16RH x 6RW
Box Quantity "210mts"
Budget
PCU : 6



GL 2020 MBT
20W x 20H x 15RH x 5RW
Box Quantity "179mts"
PCU : 9



MG 20 MB
20W x 21H x 16RH x 6RW
Box Quantity "160mts"
PCU : 7



CB 31MB
31W x 19H x 13RH x 7.5RW
Box Quantity "130mts"
Budget
PCU : 12



MG 31 MB
31W x 19H x 13RH x 7.5RW
Box Quantity "106mts"
PCU : 10



CM 716 M
25W x 15H x 9RH x 6RW
Box Quantity "170mts"
PCU : 12



GL 3120 MBT
30W x 20H x 14.5RH x 6RW
Box Quantity "104mts"
PCU : 13

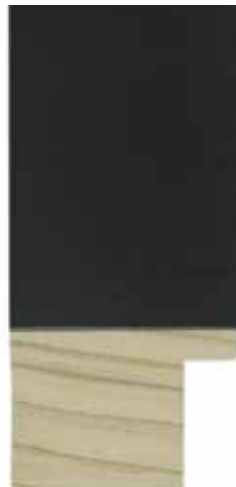

MG 3126 MB
31W x 26H x 18RH x 7RW
Box Quantity "78mts"
PCU : 14



CCF 402 MB
32W x 26.5H x 15RH x 6.7RW
Box Quantity "80mts"
PCU : 19



CB 42 MB
40.5W x 20H x 14RH x 6.5RW
Box Quantity "86mts"
Budget
PCU : 14



GL 4220 MBT
40W x 20H x 14.5RH x 7RW
Box Quantity "78mts"
PCU : 18



MG 42 MB
40W x 20H x 14RH x 7RW
Box Quantity "77mts"
PCU : 14



GL 4235 MBT
42W x 34H x 22RH x 7RW
Box Quantity "55mts"
PCU : 37



MG 4134 MB
41W x 34H x 25RH x 8.2RW
Box Quantity "61mts"
PCU : 30



GL 6020 MBT
60W x 20H x 14.5RH x 6.5RW
Box Quantity "52mts"
PCU : 38

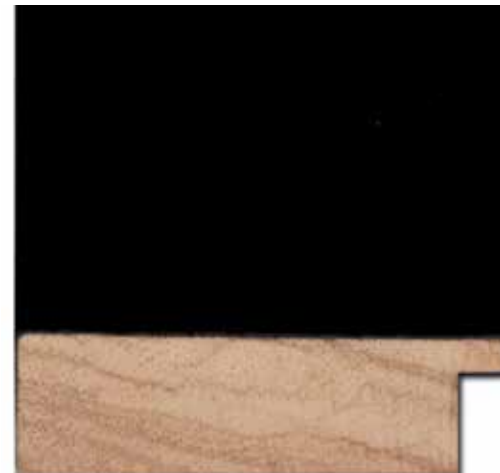

CM 370 MB
65W x 20H x 15RH x 6.7RW
Box Quantity "67mts"
PCU : 30

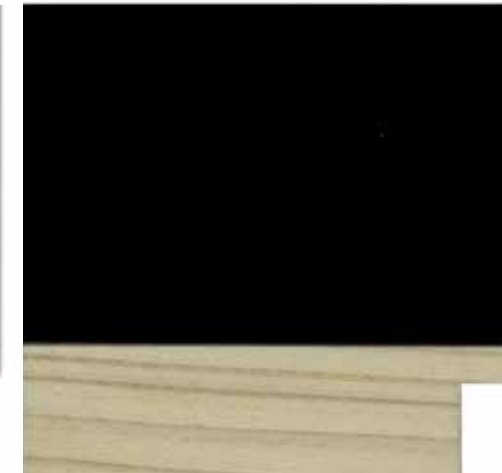

MG 65 MB
65W x 20H x 15RH x 6.7RW
Box Quantity "43mts"
PCU : 30



CM 312-JS (GLOSS)
11W x 14H x 9RH x 3.7RW
Box Quantity "280mts"
PCU : 9



CM 312 M
11W x 14H x 9RH x 3.7RW
Box Quantity "280mts"
PCU : 9



OP1222-1 BK
12W x 23H x 17RH x 5RW
Box Quantity "400mts"
PCU : 4



CM 912 JS (GLOSS)
13W x 15.5H x 9.5RH x 4RW
Box Quantity "400mts"
PCU : 11



CM 912 MBG
13W x 15.5H x 9.5RH x 4RW
Box Quantity "400mts"
PCU : 11



• OP1320 BK
13W x 20H x 15RH x 5RW
Box Quantity "400mts"
PCA : 9



• APM 8 BK
13W x 14H x 9RH x 4.5RW
Box Quantity "430mts"
PCA : 8



CM 320-1 BKG
13.5W x 13H x 7.5RH x 4.3RW
Box Quantity "220mts"
PCU : 12



CM 320-2 BKS
13.5W x 13H x 7.5RH x 4.3RW
Box Quantity "220mts"
PCU : 12



CM 110 M
14W x 22H x 16RH x 5RW
Box Quantity "274mts"
PCU : 12



CH 6019-8
14W x 14H x 9.5RH x 5.2RW
Box Quantity "220mts"
PCU : 10



APM-CM 4008 BK
15W x 41H x 19RH x 7RW
Box Quantity "108mts"
PCA : 42



CM 5528-321
15W x 13.5H x 9RH x 5.4RW
Box Quantity "500mts"
PCU : 12



CM 5528-571 (GLOSS)
15W x 13.5H x 9RH x 5.4RW
Box Quantity "500mts"
PCU : 13



• APM 151 BK
15W x 32H x 7RH x 6RW
Box Quantity "120mts"
PCA : 18



• APM 711 BK
16W x 19H x 6RH x 6RW
Box Quantity "250mts"
PCA : 13



• APM 19 BK
18W x 20H x 10RH x 6RW
Box Quantity "180mts"
PCA : 18



• APM 408 BK
19W x 27H x 22RH x 6RW
Box Quantity "144mts"
PCA : 17



• APM 408-1
19W x 27H x 22R x 6RW
Box Quantity "144mts"
PCA : 17



• APM 408 RBK
19W x 27H x 22RH x 6RW
Box Quantity "144mts"
PCA : 19



• APM/CM 1248 BK
19W x 67H x 12RH x 6RW
Box Quantity "55mts"
PCA : 50



• APM 1 CARBON
19W x 40H x 35RH x 6RW
Box Quantity "70mts"
PCA : 41



CL 601-3
19W x 28H x 22RH x 7RW
Box Quantity "160mts"
PCU : 19



• APM 1 BLACK
19W x 40H x 35RH x 6RW
Box Quantity "70mts"
PCA : 41



• APM 24 CHARCOAL
19W x 41H x 12RH x 6RW
Box Quantity "50mts"
PCA : 40



• RAW 24 BLACK
19W x 41H x 12RH x 6RW
Box Quantity "50mts"
PCA : 40



MG 2040 MB
20W x 40H x 35RH x 6.8RW
Box Quantity "92mts"
PCU : 25



APM 408-40 CHA
19W x 40H x 34RH x 7RW
Box Quantity "80mts"
PCA : 38



• APM 1 CHARCOAL
19W x 40H x 35RH x 6RW
Box Quantity "70mts"
PCA : 41



• APM 24 CARBON
19W x 41H x 12RH x 6RW
Box Quantity "50mts"
PCA : 40



CH 6012 - 5
20W x 40H x 35.5RH x 5.5RW
Box Quantity "113mts"
PCU : 29



• APM 418 BK
20W x 14H x 9RHx 6RW
Box Quantity "216mts"
PCA : 13



• APM 79 BKG Y
20W x 20H x 6RHx 6.5RW
Box Quantity "180mts"
PCA : 13



CM 5998-1 MB
20W x 15H x 10RHx 6RW
Box Quantity "219mts"
PCU : 6



GL 2020 MBT
20W x 20H x 15RH x 5RW
Box Quantity "179mts"
PCU : 9



MG 20 MB
20W x 21H x 16RH x 6RW
Box Quantity "160mts"
PCU : 7



CH 6005 / 5
20W x 21H x 16RH x 5.8RW
Box Quantity "210mts"
PCU : 8



OP 2020 BK
20W x 20H x 14RH x 5.5RW
Box Quantity "220mts"
PCU : 11



• APM 407 CARB
20W x 22H x 16RH x 6.5RW
Box Quantity "140mts"
PCA : 20



• APM 407 CHARC
20W x 22H x 16RH x 6.5RW
Box Quantity "140mts"
PCA : 20



DC 3760-1
21W x 21H x 10RH x 6RW
Box Quantity "150mts"
PCU : 17



DC 3760-2
21W x 21H x 10RH x 6RW
Box Quantity "150mts"
PCU : 17



DC 3760-3
21W x 21H x 10RH x 6RW
Box Quantity "150mts"
PCU : 17



APM 407 BLACK OAK
20W x 22H x 16RH x 6.5RW
Box Quantity "140mts"
PCA : 21



CM 033 - 167 MB
20W x 32H x 27RHx 5.5RW
Box Quantity "140mts"
PCU : 17



CM 154 B-Gloss
21.5W x 16H x 8RHx 5RW
Box Quantity "283mts"
PCU : 14



CM 154 M
21.5W x 16H x 8RHx 5RW
Box Quantity "283mts"
PCU : 12



CM 1000 MB
21W x 21.5H x 11RHx 5.7RW
Box Quantity "300mts"
PCU : 12



CM 838 JS-Gloss
22.5W x 18H x 8.5RHx 6RW
Box Quantity "211mts"
PCU : 19



CM 838 MBG
22.5W x 18H x 8.5RHx 6RW
Box Quantity "211mts"
PCU : 19



OP 1938 BK
20W x 38H x 31RHx 6RW
Box Quantity "88mts"
PCU : 17



CM 838 MBS
23W x 18H x 9RHx 5.5RW
Box Quantity "232mts"
PCU : 19



IT-9221 ANTRACITE
23W x 24H x 14.5RHx 5.5RW
Box Quantity "200mts"
PCU : 36



CH 6012-13 gloss black
21W x 41H x 34.5RHx 5.5RW
Box Quantity "80mts"
PCU : 36



APM 1249 MB
22.5W x 90.5H x 11.5RHx 7.5RW
Box Quantity "36mts"
PCU : 55



CM 1075 JS GLOSS
23W x 21H x 13RH x 5.7RW
Box Quantity "190mts"
PCU : 26



CM 1075 MBG
23W x 21H x 13RHx 5.7RW
Box Quantity "190mts"
PCU : 26



CM 055 MB
23W x 13H x 8RHx 5.7RW
Box Quantity "263mts"
PCU : 13



CM 2201 JS-Gloss
23W x 23H x 14RHx 6.2RW
Box Quantity "150mts"
PCU : 24



IT-2317 NERO
25W x 20H x 12RH x 5RW
Box Quantity "220mts"
PCE : 30



OP2213-1 BK
23W x 13H x 9.5RHx 5RW
Box Quantity "400mts"
PCU : 4



• APM 150 EBK
25W x 40H x 15RH x 7RW
Box Quantity "50mts"
PCA : 28



• APM 150 RBK
25W x 40H x 15RH x 7RW
Box Quantity "50mts"
PCA : 28



• APM 152 EBLK
25W x 60H x 15RH x 7RW
Box Quantity "45mts"
PCA : 42



• APM 152 RBK
25W x 60H x 15RH x 7RW
Box Quantity "100mts"
PCA : 42



• APM 152 CARBON
25.5W x 60H x 15RH x 7.5RW
Box Quantity "50mts"
PCA : 42



• APM 152 CHARCOAL
25.5W x 60H x 15RH x 7.5RW
Box Quantity "50mts"
PCA : 42



• CM 152 BK
25W x 60H x 14RH x 7RW
Box Quantity "50mts"
PCU : 36



CL 2789 BLACK
24W x 29H x 15RH x 5.5RW
Box Quantity "75mts"
PCU : 20



IT-215 NERO
25W x 23H x 17RH x 6RW
Box Quantity "200mts"
PCE : 36



CM 716 JS (GLOSS)
25W x 15H x 9RH x 6RW
Box Quantity "172.8mts"
PCU : 14



CM 716 M
25W x 15H x 9RH x 6RW
Box Quantity "172.8mts"
PCU : 12



ACM 63 BLK
25W x 17H x 7RH x 6RW
Box Quantity 90mt
Price Code ACM B



• APM 700 BK
26W x 32H x 11RH x 6.5RW
Box Quantity "72mts"
PCA : 18



CH 6014 - 2
26W x 21.5H x 11.5RH x 7.2RW
Box Quantity "130mts"
PCU : 13



CH 6014 - 1
26W x 21.5H x 11.5RH x 7RW
Box Quantity "130mts"
PCU : 13



GL 2040 MBT
20W x 40H x 35RH x 5.8RW
Box Quantity "92mts"
PCU : 24



CM 23601 M
27W x 54H x 42RH
Box Quantity "50mts"
PCU : 42



CH 6013-8
20W x 60H x 55RH x 5.3RW
Box Quantity "66mts"
PCU : 30



OP 2845 BK
28W x 45H x 40RH x 7RW
Box Quantity "70mts"
PCU : 40



CM 720 MBGL
29W x 18.5H x 8RH x 6RW
Box Quantity "140mts"
PCU : 20



• APM 402 BLACK OAK
30W x 19H x 13RH x 6RW
Box Quantity "100mts"
PCA : 24



CM 740-1 MB
30W x 30H x 10RH x 9.5RW
Box Quantity "90mts"
PCU : 17



MG 31 MB
31W x 19H x 13RH x 7.5RW
Box Quantity "106mts"
Budget PCU : 10



GL 3120 MBT
30W x 20H x 14.5RH x 6RW
Box Quantity "104mts"
Budget PCU : 13



CM 410 MB
30.5W x 22H x 9RH x 7.3RW
Box Quantity "152mts"
PCU : 21



• APM 422 BK
30W x 20H x 10RH x 7RW
Box Quantity "120"
PCA : 20



OP 3017 BK
30W x 17H x 12RH x 6RW
Box Quantity "160mts"
PCU : 14



CH 6006/5
31W x 20H x 17RH x 5.5RW
Box Quantity "120mts"
PCU : 11



OP 2845 BK
28W x 45H x 34RH x 9RW
Box Quantity "70mts"
PCU : 41



• APM 4043 CARBON
30W x 42H x 12RH x 7RW
Box Quantity "50mts"
PCA : 46



• APM 4043 CHARCOAL
30W x 42H x 12RH x 7RW
Box Quantity "50mts"
PCA : 46



• RAW 4043 OAK BK
30W x 42H x 12RH x 7RW
Box Quantity "50mts"
PCA : 46



• APM 422 EBK
30W x 19H x 13RH x 7RW
Box Quantity "100mts"
PCA : 19



• APM 422 ERBK
30W x 19H x 13RH x 7RW
Box Quantity "100mts"
PCA : 19



CM 740-13 (GLOSS)
30W x 30H x 10RH x 9.5RW
Box Quantity "60mts"
PCU : 36



DC 513 MBK
31W x 23H x 17RH x 5.9RW
Box Quantity "130mts"
PCU : 12



MG 3126 MB
31W x 26H x 18RH x 7RW
Box Quantity "78mts"
PCU : 14



OP 3125 BK
31W x 25H x 19RH x 7RW
Box Quantity "120mts"
PCU : 18



CL 603-3
32W x 20H x 15RH x 7RW
Box Quantity "104mts"
PCU : 19



• APM 608 BK
31W x 12.5H x 6.5RH x 7RW
Box Quantity "105mts"
PCA : 17



CCF 402 MB
32W x 26.5H x 15RH x 6.7RW
Box Quantity "112mts"
PCU : 19



• APM 153 BKS
32W x 18H x 10RH x 7RW
Box Quantity "120mts"
PCA : 15



• APM 153 BKG
32W x 18H x 10RH x 7RW
Box Quantity "120mts"
PCA : 15



• APM 200 BK
32W x 30H x 5RH
Box Quantity "60mts"
PCA : 22



• APM 3409 BKS
32W x 20H x 10.5RH x 7RW
Box Quantity "120mts"
PCA : 20



• APM 3409 BKG
32W x 20H x 10.5RH x 7RW
Box Quantity "120mts"
PCA : 20



VC 405 - 1
33W x 22H x 14RH x 6RW
Box Quantity "127mts"
PCU : 22



• APM 604 RBK
32W x 32H x 23RH x 7RW
Box Quantity "100mts"
PCA : 23



• APM 604 EBK
32W x 32H x 23RH x 7RW
Box Quantity "100mts"
PCA : 23



DC 2337 - 3
33W x 36H x 28RH x 6RW
Box Quantity "50mts"
PCU : 43



DC 2337 - 4
33W x 36H x 28RH x 6RW
Box Quantity "50mts"
PCU : 43



CM 201 - 410 MB
33W x 22H x 14RH x 5RW
Box Quantity "120mts"
PCU : 19



APM 590 CHARCO
33W x 14H x 9RH
Box Quantity "100mts"
PCA : 24
metallic



• APM 3410 BKG
33W x 68H x 58RH x 7RW
Box Quantity "54mts"
PCA : 50



CM 185 BKS (Gloss)
34W x 20H x 12RH x 7.2RW
Box Quantity "112mts"
PCU : 22

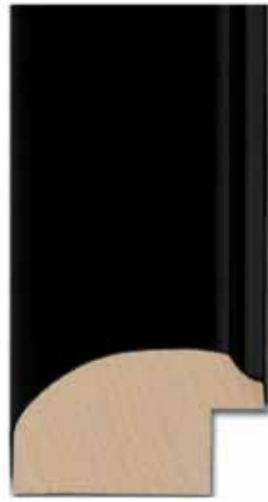

CM 185 M
34W x 20H x 12RH x 7.2RW
Box Quantity "112mts"
PCU : 22



CM 185 B (Gloss)
34W x 20H x 12RH x 7.2RW
Box Quantity "112mts"
PCU : 22



CM 185 BNGL
34W x 20H x 12RH x 7.2RW
Box Quantity "112mts"
PCU : 22



• APM 989 BLK
32W x 30H x 25RH x 9RW
Box Quantity "100mts"
PCA : 25



DC 2026-1
35W x 22H x 12RH x 6RW
Box Quantity "100mts"
PCU : 22



DC 2026-2
35W x 22H x 12RH x 6RW
Box Quantity "100mts"
PCU : 22



DC 3762-1
36W x 21.5H x 10.5RH x 6RW
Box Quantity "80mts"
PCU : 28



DC 3762-2
36W x 21.5H x 10.5RH x 6RW
Box Quantity "80mts"
PCU : 28



DC 3762-3
36W x 21.5H x 10.5RH x 6RW
Box Quantity "80mts"
PCU : 28



DC 4642-2
36W x 21.5H x 9.5RH x 7RW
Box Quantity "104mts"
PCU : 24



IT-216 NERO
36W x 35H x 28RH x 7.5RW
Box Quantity "100mts"
PCE : 46



CM 5237 BG
36.5W x 23H x 14RH x 7RW
Box Quantity "104mts"
PCU : 19



CM 5237 BS
36.5W x 23H x 14RH x 7RW
Box Quantity "104mts"
PCU : 19



CM 195 MB
38W x 20.5H x 9RH x 6.8RW
Box Quantity "97.6mts"
PCU : 25



CM 870 MBG
39W x 22.5H x 16RH x 7.3RW
Box Quantity "80mts"
PCU : 23



CM 870 MBS
39W x 22.5H x 16RH x 7.3RW
Box Quantity "80mts"
PCU : 23



CM 960 MBG
40W x 22H x 17RH x 6RW
Box Quantity "122mts"
PCU : 23



OP 4020 BK
40W x 20H x 15RH x 7RW
Box Quantity "90mts"
PCU : 17



CH 6016-5
40W x 20H x 9RH x 6.8RW
Box Quantity "150mts"
PCU : 15



ACM 400 BLK
41W x 38H x 12RH x 7RW
Box Quantity 45mt
Price Code ACM O



CM 4220 MB
40W x 22H x 10RH x 7RW
Box Quantity "86mts"
PCU : 19



CL 4118 BLACK
41W x 27H x 13RH x 6.5RW
Box Quantity "58mts"
PCU : 37



MG 42 MB
40W x 20H x 7RH x 7RW
Box Quantity "77mts"
Budget
PCU : 14



GL 4220 MBT
40W x 20H x 14.5RH x 7RW
Box Quantity "78mts"
PCU : 18



DC 2338-3
41W x 15H x 8RH x 6.9RW
Box Quantity "100mts"
PCU : 30



• APM 704 RBK
42W x 35H x 25RH x 7RW
Box Quantity "48mts"
PCA : 30



• APM 704-1
42W x 35H x 25RH x 7RW
Box Quantity "48mts"
PCA : 30



• APM 704-3
42W x 35H x 25RH x 7RW
Box Quantity "48mts"
PCA : 30



• APM 3509 BKS
42W x 20H x 8RH x 7RW
Box Quantity "90mts"
PCA : 22



• APM 3509 BKG
42W x 20H x 8RH x 7RW
Box Quantity "90mts"
PCA : 22



• APM 174 BKS
42W x 20H x 11.5RH x 7RW
Box Quantity "90mts"
PCA : 22



• APM 704 BK
42W x 35H x 25RH x 7RW
Box Quantity "48mts"
PCA : 30



• APM 609 BLACK
42W x 19H x 10.5RH x 7RW
Box Quantity "90mts"
PCA : 21



• APM 701 BK
42W x 32H x 10RH x 7RW
Box Quantity "72mts"
PCA : 30



CM 201/415 JS
42W x 35H x 25RH x 8.2RW
Box Quantity "42mts"
PCU : 39



CM 201 - 415 MBS
42W x 35H x 25RH x 8.2RW
Box Quantity "61mts"
PCU : 40



MG 4134 MB
41W x 34H x 25RH x 8.2RW
Box Quantity "61mts"
PCU : 30



GL 4235 MBT
42W x 34H x 22RH x 7RW
Box Quantity "55mts"
PCU : 37



CCF 410 MB
43W x 20H x 10.5RH x 5.5RW
Box Quantity "90mts"
PCU : 19



DC 867-2 BK
44W x 21H x 15RH x 7RW
Box Quantity "87mts"
PCU : 36



CH 8009-1
44.5W x 18H x 6.6RH x 6.5RW
Box Quantity "110mts"
PCU : 25



CH 8009-2
44.5W x 18H x 6.6RH x 6.5RW
Box Quantity "110mts"
PCU : 25



DC 815 SLBK
46W x 23H x 11.5RH x 5.8RW
Box Quantity "100mts"
PCU : 36



CM 2001 MB
46W x 22H x 9.5RH x 8.7RW
Box Quantity "78mts"
PCU : 23



CM 2001 JS (Gloss)
46W x 22H x 9.5RH x 8.7RW
Box Quantity "78mts"
PCU : 41



DC 327 MBWX
47.5W x 22.5H x 11RH x 5.8RW
Box Quantity "100.6mts"
PCU : 33



CH 6008/8 BK
48W x 19H x 12RH x 6.8RW
Box Quantity "72mts"
PCU : 26



CM 5248 BS
47.5W x 23H x 13RH x 6.8RW
Box Quantity "70mts"
PCU : 27



CM 5248 BG
47.5W x 23H x 13RH x 6.8RW
Box Quantity "70mts"
PCU : 27



CM 730 MBGL
49W x 20.5H x 9RH x 7RW
Box Quantity "70mts"
PCU : 36



CM 750-1 MB
48W x 48H x 25RH x 12RW
Box Quantity "50mts"
PCU : 43



CCF 408 MB
49W x 63H x 52RH x 8.5RW
Box Quantity "36mts"
PCU : 50



IT-2318 NERO
50W x 25H x 15RH x 10RW
Box Quantity "80mts"
PCE : 47



CCF 403 MB
50W x 20H x 10RH x 8RW
Box Quantity "97mts"
PCU : 20



IT-9222 ANTACITE
51W x 29H x 12RH x 7RW
Box Quantity "70mts"
PCE : 50



• APM 610 BLACK
52W x 19H x 10.5RH x 7RW
Box Quantity "72mts"
PCA : 23



CM 640-1 MB
53W x 31H x 11RH x 7.9RW
Box Quantity "50mts"
PCU : 36



• APM 3715 BK
56W x 20H x 9RH x 7RW
Box Quantity "54mts"
PCA : 33

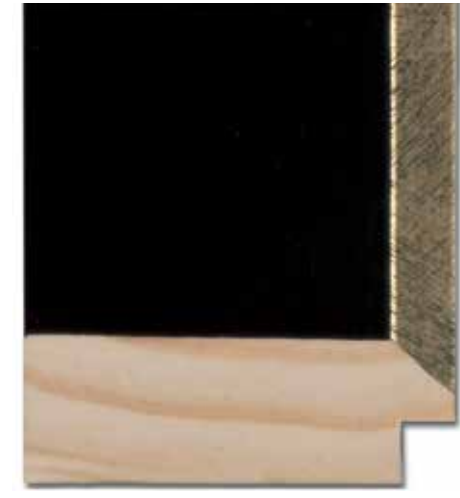

• APM 3715 BKSG
56W x 20H x 9RH x 7RW
Box Quantity "54mts"
PCA : 33



• APM 3609 BKG
56W x 20H x 9RH x 7RW
Box Quantity "60mts"
PCA : 33



• APM 3609 BKS
56W x 20H x 9RH x 7RW
Box Quantity "60mts"
PCA : 33



VC 404-1
54W x 34H x 14RH x 6.7RW
Box Quantity "44mts"
PCU : 45



VC 404-2
54W x 34H x 14RH x 6.7RW
Box Quantity "44mts"
PCU : 45



• APM 630 BK
56W x 20H x 8RH x 7RW
Box Quantity "72mts"
PCA : 33



CCF 404 MB
56W x 20H x 12RH x 6.5RW
Box Quantity "90mts"
PCU : 20



GL 6020 MBT
60W x 20H x 14.5RH x 6.5RW
Box Quantity "52mts"
PCU : 38



DC 2027-2
58W x 22.5H x 10RH x 7.5RW
Box Quantity "55mts"
PCU : 36



• APM 706 EBK
60W x 19H x 12.5R x 7RW
Box Quantity "36mts"
PCA : 36



• APM 702 BK
62W x 32H x 12RH x 7RW
Box Quantity "54mts"
PCA : 42



ACM 600 BLK
60W x 56H x 18RH x 7RW
Box Quantity 12mt
Price Code ACM U



OP 6247 BK
62W x 47H x 19RH x 10RW
Box Quantity "40mts"
PCU :51



VC 406-1
60W x 20H x 11RH x 6RW
Box Quantity "60mts"
PCU : 35



CM 624 MB
60W x 28H x 20RH x 7RW
Box Quantity "57.5mts"
PCU : 45



• APM 706 RBK
64W x 19H x 12.5RH x 7RW
Box Quantity "60mts"
PCA : 36

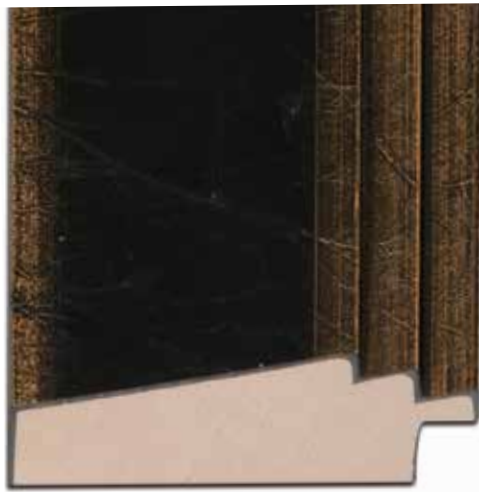

CH 8008-1
67W x 23H x 11.5RH x 7.5RW
Box Quantity "55mts"
PCU : 42



CH 8008-2
67W x 23H x 11.5RH x 7.5RW
Box Quantity "55mts"
PCU : 42

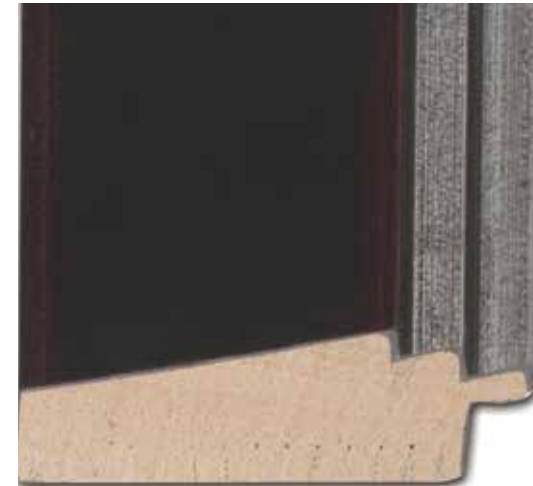

CH 8008-4
67W x 23H x 11.5RH x 7.5RW
Box Quantity "55mts"
PCU : 42

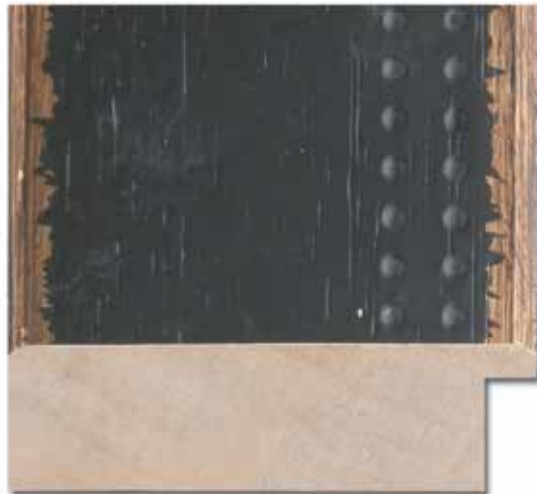

DC 868-2 BK
69W x 21H x 15RH x 7RW
Box Quantity "49mts"
PCU : 48

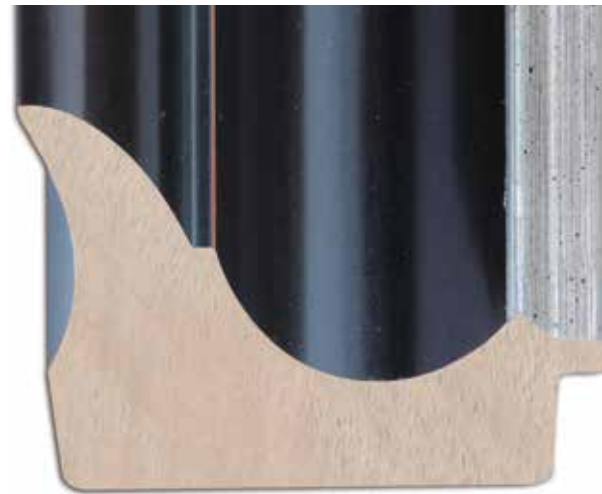

CH 9108-2 BLACK With BROWN
77W x 53H x 16RH x 7.5RW
Box Quantity "20mts"
PCU : 56

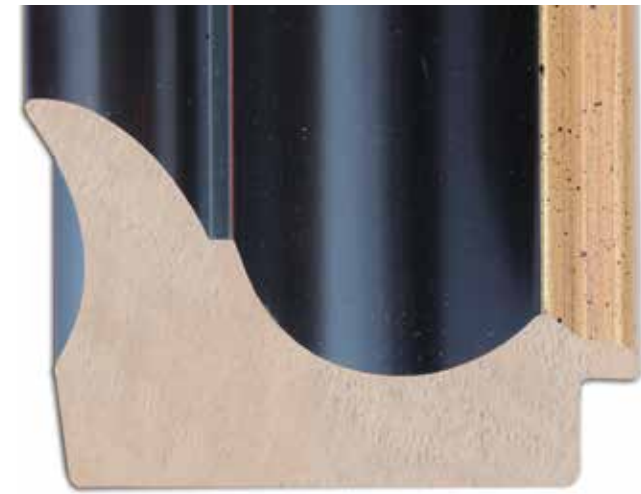

CH 9108-3 BLACK With BROWN
77W x 53H x 16RH x 7.5RW
Box Quantity "20mts"
PCU : 56



CM 370 MB
65W x 21H x 15RH x 6.7RW
Box Quantity "67mts"
PCU : 36

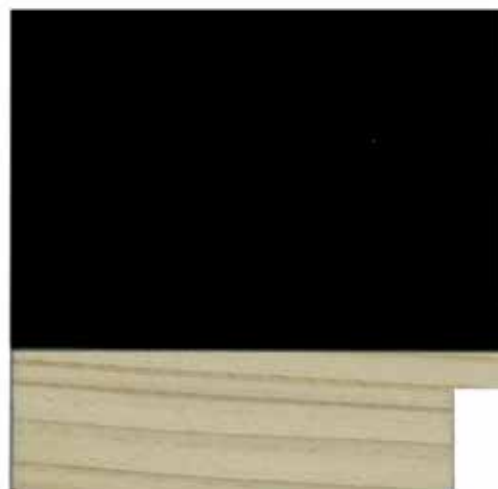

MG 65 MB
65W x 20H x 15RH x 6.7RW
Box Quantity "43mts"
PCU : 30



CL 6124 BLACK
66W x 30H x 14RH x 7.5RW
Box Quantity "40mts"
PCU : 46



• APM 611 RBK
68W x 19H x 12.5RH x 7RW
Box Quantity "63mts"
PCA : 31



DC 1930-1
68W x 28H x 15RH x 6.8RW
Box Quantity "38mts"
PCU : 48



DC 1930-2
68W x 28H x 15RH x 6.8RW
Box Quantity "38mts"
PCU : 48



ACM 61 BLK
70W x 36H x 10RH x 7RW
Box Quantity 27mt
Price Code ACM L



DC 816 SLBK
70W x 29.5H x 14.5RH x 7.5RW
Box Quantity "61mts"
PCU : 52



DC 816 GLBK
70W x 29.5H x 14.5RH x 7.7RW
Box Quantity "61mts"
PCU : 52



CCF 406 MB
82W x 20.5H x 14RH x 6.5RW
Box Quantity "64mts"
PCU : 43

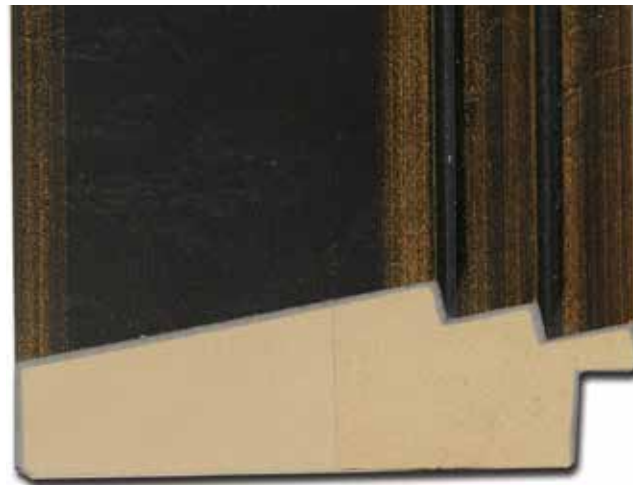

CH 8010-1
85W x 28H x 14RH x 8.1RW
Box Quantity "33mts"
PCU : 51



CH 8010-2
85W x 28H x 14RH x 8.1RW
Box Quantity "33mts"
PCU : 51



ACM 700 BK



• APM 507 EBLACK
90W x 19H x 12RH x 7RW
Box Quantity "33mts"
PCU : 47

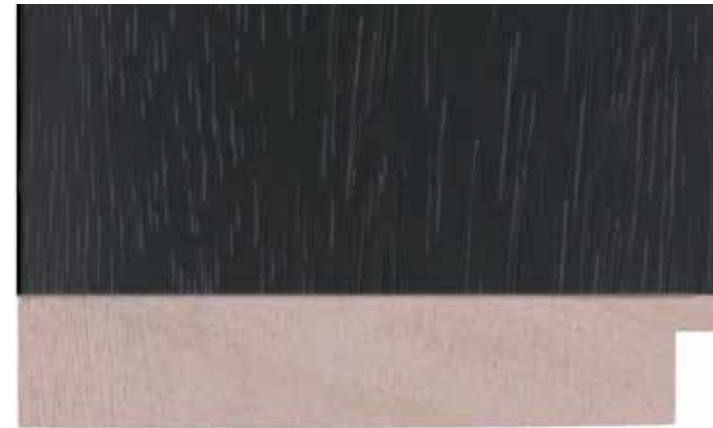

OP 11023 BK
110W x 23H x 17RH x 8RW
Box Quantity "35mts"
PCU : 51



ACM 800 BLK
91W x 46H x 35RH x 10RW
Box Quantity 12mt
Price Code ACM Y

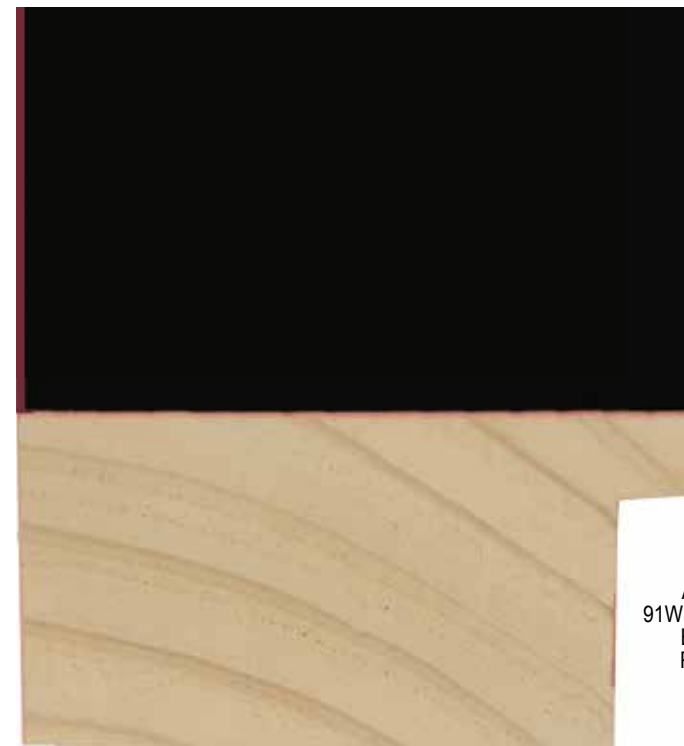

ACM 800 MOCCA
91W x 46H x 35RH x 10RW
Box Quantity 12mt
Price Code ACM Y

EVERYDAY WHITE



MG 20 WH
20W x 21H x 16RH x 6RW
Box Quantity "190mts"
PCU : 7

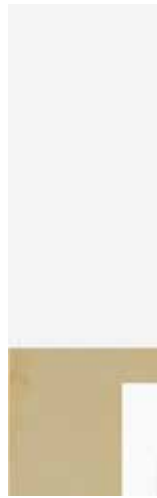

GL 2020 WHT
20W x 20H x 15RH x 6RW
Box Quantity "179mts"
PCU : 9



CM 033-167 WH
20W x 32H x 27RH x 5.5RW
Box Quantity "100mts"
PCU : 17



MG 2040 WH
20W x 40H x 35RH x 6.8RW
Box Quantity "92mts"
PCU : 25



GL 2040 WHT
20W x 40H x 35RH x 5.8RW
Box Quantity "92mts"
PCU : 28



MG 31 WH
31W x 19H x 13RH x 7.5RW
Box Quantity "98mts"
PCU : 10

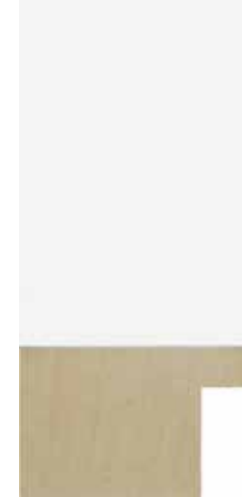

GL 3120 WHT
30W x 20H x 14.5RH x 6RW
Box Quantity "104mts"
PCU : 13



MG 3126 WH
31W x 26H x 18RH x 7RW
Box Quantity "78mts"
PCU : 14



CB 31 WH
40W x 20H x 9RH x 6.8RW
Box Quantity "150mts"
PCU : 12

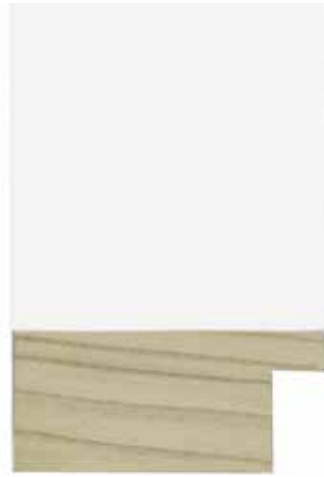

MG 42 WH
40W x 20H x 7RH x 7RW
Box Quantity "86mts"
PCU : 14

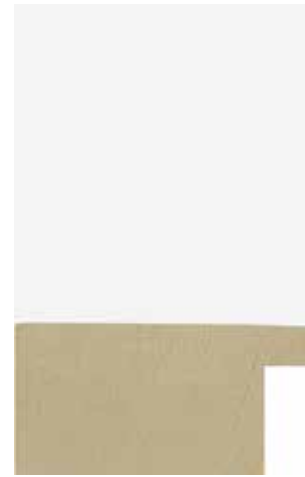

GL 4220 WHT
40W x 20H x 14.5RH x 7RW
Box Quantity "78mts"
PCU : 18



GL 4235 WHT
42W x 34H x 22RH x 7RW
Box Quantity "55mts"
PCU : 37



MG 4134 WH
41W x 34H x 25RH x 8.2RW
Box Quantity "46mts"
PCU : 30



CM 2005 WH
46W x 22H x 9.5RH x 8.7RW
Box Quantity "55mts"
PCU : 26

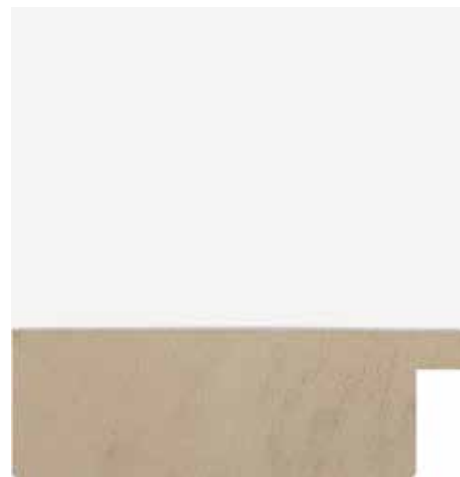

GL 6020 WHT
60W x 20H x 14.5RH x 6.5RW
Box Quantity "52mts"
PCU : 38

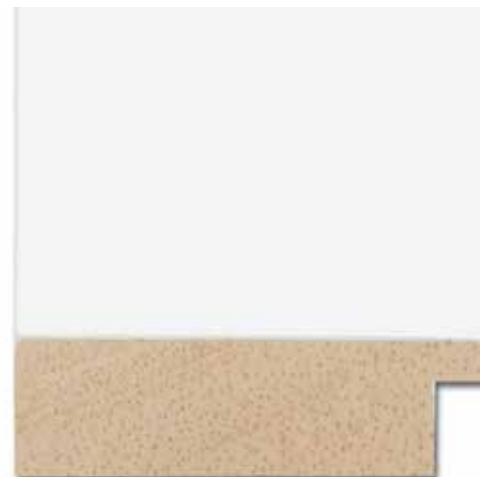

CM 6007 / 7
61W x 20.5H x 14RH x 7RW
Box Quantity "66mts"
PCU : 30

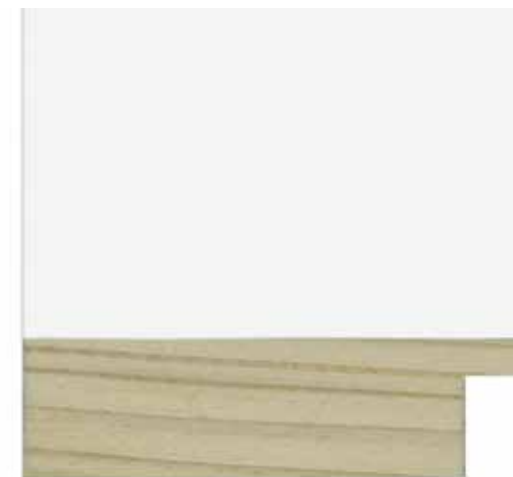

MG 65 WH
65W x 20H x 15RH x 6.7RW
Box Quantity "43mts"
PCU : 30

White



OP 1222-2 WH
12W x 23H x 17RH x 5RW
Box Quantity "400mts"
PCU : 4



OP 1320 WH
13W x 20H x 15RH x 5RW
Box Quantity "400mts"
PCU : 9



CH 6019-7
14W x 14H x 9.5RH x 5.2RW
Box Quantity "280mts"
PCU : 10



CL 600-5
15W x 20H x 15RH x 6RW
Box Quantity "175mts"
PCA : 14



APM 4008 WH
15W x 41H x 19RH x 7RW
Box Quantity "108mts"
PCA : 42



APM 711 WH
16W x 19H x 6RH x 6RW
Box Quantity "250mts"
PCA : 13



• APM 408-2
19W x 27H x 22RH x 6RW
Box Quantity "144mts"
PCA : 19



OP 1938 CRE
20W x 38H x 31RH x 6RW
Box Quantity "140mts"
PCU : 19



CL 601-2
19W x 28H x 22RH x 7RW
Box Quantity "160mts"
PCU : 19



OP 1938 WH
19W x 38H x 30RH x 7RW
Box Quantity "140mts"
PCU : 17



APM 24 CHALK
19W x 41H x 12RH x 6RW
Box Quantity "50mts"
PCA : 40



OP 2060 WH
20W x 60H x 53RH x 6RW
Box Quantity "90mts"
PCU : 41



CH 6013-7
20W x 60H x 55RH x 5.3RW
Box Quantity "66mts"
PCU : 45



APM 1249 WH
22.5Wx90.5H x11.5RH x 7.5RW
Box Quantity "36mts"
PCU : 55



• CM 152 WH
25W x 60H x 14RH x 7RW
Box Quantity "50mts"
PCU : 36



• APM 152 EWHITE
25W x 60H x 15RH x 7RW
Box Quantity "50mts"
PCA : 42



APM 1 CHALK
19W x 40H x 35RH x 6RW
Box Quantity "70mts"
PCA : 41



OP 2020 WH
20W x 20H x 14RH x 5.5RW
Box Quantity "220mts"
PCU : 11



• APM 407 CHALK
20W x 22H x 16RH x 6.5RW
Box Quantity "140mts"
PCA : 21



CM 5998 -2WH
20W x 15H x 10RH x 6RW
Box Quantity "200mts"
PCU : 6



MG 20 WH
20W x 21H x 16RH x 6RW
Box Quantity "190mts"
PCU : 6



GL 2020 WHT
20W x 20H x 15RH x 6RW
Box Quantity "179mts"
PCU : 9



CM 033-167 WH
20W x 32H x 27RH x 5.5RW
Box Quantity "100mts"
PCU : 17



GL 2040 WHT
20W x 40H x 35RH x 5.8RW
Box Quantity "92mts"
PCU : 24



MG 2040 WH
20W x 40H x 35RH x 6.8RW
Box Quantity "92mts"
PCU : 17



CH 6012-14 (Gloss)
21W x 41H x 34.5RH x 5.5RW
Box Quantity "80mts"
PCU : 32



OP 2213-2WH
23W x 13H x 9.5RH x 5RW
Box Quantity "400mts"
PCU : 4



CH 6017/1
22.5W x 22H x 12RH x 5.5RW
Box Quantity "200mts"
PCU : 11



CH 6017/1
22.5W x 22H x 12RH x 5.5RW
Box Quantity "200mts"
PCU : 11



CM 2205W (Gloss)
23W x 23H x 14.5RH x 6.1RW
Box Quantity "150mts"
PCU : 24



CL 2789 WHITE
24W x 29H x 15RH x 5.5RW
Box Quantity "75mts"
PCU : 20



CL 2789 CREAM
24W x 29H x 15RH x 5.5RW
Box Quantity "75mts"
PCU : 20

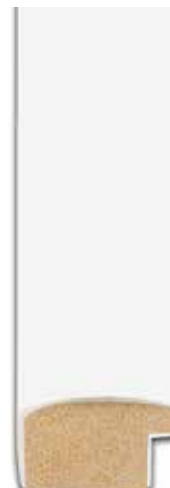

CM 716 WH
25W x 15H x 9RH x 6RW
Box Quantity "170mts"
PCU : 12



IT-2317 BIANCO
25W x 20H x 12RH x 5RW
Box Quantity "220mts"
PCE : 30



APM 150 EWH
25W x 40H x 15RH x 7RW
Box Quantity "50mts"
PCA : 28



APM 700 WH
26W x 32H x 11RH x 6.5RW
Box Quantity "72mts"
PCA : 18



APM 619 WHBR
26W x 19H x 10RH x 7RW
Box Quantity "70mts"
PCA : 14



CM 2252 - 2 WHITE
29W x 41H x 30RH x 7RW
Box Quantity "90mts"
PCU : 38



OP 2845 WH
28W x 45H x 34RH x 9RW
Box Quantity "70mts"
PCU : 41



CM 2945 WH
29W x 45H x 24.5RH x 9.5RW
Box Quantity "52mts"
PCU : 46



APM 422 WH
30W x 19H x 13.5RH x 6.5RW
Box Quantity "70mts"
PCA : 11



APM 422 EWH
30W x 18H x 13RH x 6.5RW
Box Quantity "100mts"
PCA : 19



OP 3017 WH
30W x 17H x 12RH x 6RW
Box Quantity "160mts"
PCU : 14



GL 3120 WHT
30W x 20H x 14.5RH x 6RW
Box Quantity "104mts"
PCU : 13



CM 740-2 WH
30W x 30H x 10RH x 9RW
Box Quantity "70mts"
PCU : 17



CM 740-14 GLOSS WHITE
30W x 30H x 10RH x 9RW
Box Quantity "60mts"
PCU : 36



• APM 4043 CHALK
30W x 42H x 12RH x 7RW
Box Quantity "50mts"
PCA : 46



• RAW 4043 OAK WH
30W x 42H x 12RH x 7RW
Box Quantity "50mts"
PCA : 46



GL 3120 WHT
30W x 20H x 14.5RH x 6RW
Box Quantity "104mts"
PCU : 13



MG 31 WH
31W x 19H x 13RH x 7.5RW
Box Quantity "98mts"
PCU : 10



MG 3126 WH
31W x 26H x 18RH x 7RW
Box Quantity "78mts"
PCU : 14



OP 3125 WH
31W x 25H x 19RH x 7RW
Box Quantity "120mts"
PCU : 18



• APM 608 WH
32W x 12.5H x 6.5RH x 7RW
Box Quantity "105mts"
PCA : 17



• APM 200 WH
32W x 30H x 5RH x 5RW
Box Quantity "60mts"
PCA : 22



• APM 108 WH
32W x 19H x 12RH x 7RW
Box Quantity "120mts"
PCA : 16



• APM 108 WWH
32W x 19H x 12RH x 7RW
Box Quantity "120mts"
PCA : 16



DC 2337-1
33W x 36H x 28RH x 6RW
Box Quantity "50mts"
PCU : 43



• APM 320 WHITE
32W x 20H x 9RH x 7RW
Box Quantity "100mts"
PCA : 22



CM 184 W (Gloss)
34W x 20H x 12RH x 7.2RW
Box Quantity "112mts"
PCU : 22



IT-6016-1730
38W x 20.5H x 15RH x 7RW
Box Quantity "80mts"
PCE : 33



OP 4020 WH
40W x 20H x 12RH x 8RW
Box Quantity "90mts"
PCU : 18



GL 4220 WHT
40W x 20H x 14.5RH x 7RW
Box Quantity "78mts"
PCU : 18



CL 4118 WHITE
41W x 27H x 13RH x 6.5RW
Box Quantity "58mts"
PCU : 37



CL 4118 CREAM
41W x 27H x 13RH x 6.5RW
Box Quantity "58mts"
PCU : 37

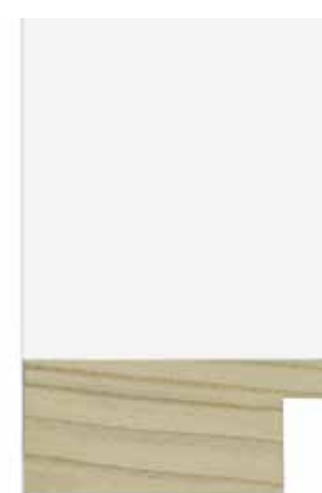

MG 42 WH
42W x 20H x 7RH x 7RW
Box Quantity "77mts"
PCU : 14



CM 221 WH
42W x 20H x 9RH x 6.2RW
Box Quantity "100mts"
PCU : 21



ACM 400 WH
41W x 38H x 12RH x 7RW
Box Quantity 45mt
Price Code ACM O



MG 4134 WH
41W x 34H x 25RH x 8.2RW
Box Quantity "61mts"
PCU : 30



DC 2338-1
41W x 15H x 8RH x 6.9RW
Box Quantity "90mts"
PCU : 30



GL 4235 WHT
42W x 34H x 22RH x 76RW
Box Quantity "55mts"
PCU : 37



• APM 704-2
42W x 35H x 25RH x 7RW
Box Quantity "48mts"
PCA : 30



• APM 704-4
42W x 35H x 25RH x 7RW
Box Quantity "48mts"
PCA : 30



• APM 704 WH
42W x 35H x 25RH x 7RW
Box Quantity "48mts"
PCA : 30



• APM 701 WH
42W x 32H x 10RH x 7RW
Box Quantity "72mts"
PCA : 30



• APM 620 WHBR
42W x 19H x 9RH x 7RW
Box Quantity "90mts"
PCA : 28



• APM 609 WH
42W x 19H x 10.5RH x 7RW
Box Quantity "90mts"
PCA : 21



• APM 174 WHS
42W x 20H x 11.5RH x 7RW
Box Quantity "90mts"
PCA : 24



• APM 569 WHITE
42W x 33H x 14RH x 7RW
Box Quantity "72mts"
PCA : 24



CM 201/415 GLW
42W x 35H x 25RH x 8.2RW
Box Quantity "42mts"
PCU : 38



• APM 139 WH
43W x 20H x 8RH x 7RW
Box Quantity "108mts"
PCA : 24



DC 867-1 WH
44W x 21H x 15RH x 7RW
Box Quantity "87mts"
PCU : 36



CM 2005 W (Gloss)
46W x 22H x 9.5RH x 8.7RW
Box Quantity "78mts"
PCU : 41



CM 2005 WH
46W x 22H x 9.5RH x 8.7RW
Box Quantity "55mts"
PCU : 23



CH 6008/7
48W x 19H x 12RH x 6.8RW
Box Quantity "72mts"
PCU : 36



IT-2318 BIANCO
51W x 25.5H x 15RH x 10RW
Box Quantity "80mts"
PCE : 47



CM 750-2 WH
48W x 48H x 25RH x 12RW
Box Quantity "50mts"
PCU : 43



• APM 143 WH
57W x 20H x 7RH x 7RW
Box Quantity "72mts"
PCA : 28



• APM 99 WH
56W x 20H x 10RH x 7RW
Box Quantity "66mts"
PCA : 28



• APM 706 EWH
60W x 19H x 12.5R x 7RW
Box Quantity "36mts"
PCA : 36



ACM 600 WH
60W x 56H x 18RH x 7RW
Box Quantity 12mt
Price Code ACM U



OP 6247 WH
62W x 47H x 19RH x 10RW
Box Quantity "40mts"
PCU : 51



• APM 570 WHITE
66W x 32H x 15RH x 7RW
Box Quantity "40mts"
PCA : 42



CCF 408 WH
49W x 63H x 52RH x 8.5RW
Box Quantity "40mts"
PCU : 50



• APM/CM 1248 WH
19W x 67H x 12RH x 6RW
Box Quantity "55mts"
PCA : 50



GL 6020 WHT
60W x 20H x 14.5RH x 6.5RW
Box Quantity "52mts"
PCU : 38



CH 6007 / 7
61W x 20.5H x 14RH x 7RW
Box Quantity "66mts"
PCU : 30



• APM 702 WH
62W x 32H x 12RH x 7RW
Box Quantity "54mts"
PCA : 42



• APM 102 WHITE
64W x 19H x 12.5RH x 7RW
Box Quantity "60mts"
PCA : 46

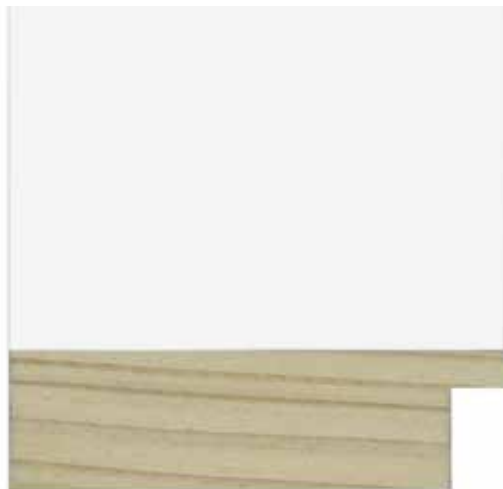

MG 65 WH
65W x 20H x 15RH x 6.7RW
Box Quantity "43mts"
PCU : 30



APM 268 WH
65W x 20H x 10RH x 7RW
Box Quantity "60mts"
PCA : 35



APM 104 RWH
65W x 18H x 12RH x 7RW
Box Quantity "54mts"
PCA : 33



CL 6124 WHITE
66W x 30H x 14RH x 7.5RW
Box Quantity "40mts"
PCU : 46



CL 6124 CREAM
66W x 30H x 14RH x 7.5RW
Box Quantity "40mts"
PCU : 46



• APM 625 WHBR
68W x 27H x 7RH x 7RW
Box Quantity "50mts"
PCA : 40



• APM 92 WH
67W x 20H x 10RH x 7RW
Box Quantity "60mts"
PCA : 35

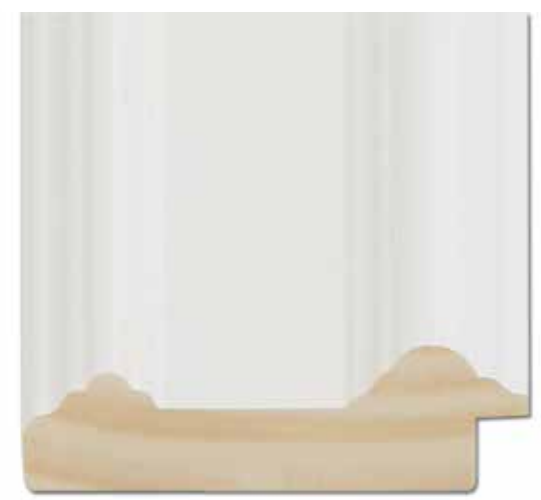

• APM 92 GLOSS W
67W x 20H x 10RH x 7RW
Box Quantity "60mts"
PCU : 35



• APM 611 WH
68W x 19H x 12.5RH x 7RW
Box Quantity "63mts"
PCA : 31



DC 868-1 WH
69W x 21H x 15RH x 7RW
Box Quantity "49mts"
PCU : 48



• APM 351 WH
80W x 32H x 9RH x 7RW
Box Quantity "36mts"
PCA : 47



ACM 700 WH
88W x 82H x 26RH x 10RW
Box Quantity 12mt
Price Code ACM X



• APM 507 EPUREW
90W x 19H x 12RH x 7RW
Box Quantity "36mts"
PCA : 47



OP 11023 WH
110W x 23H x 17RH x 8RW
Box Quantity "35mts"
PCU : 51

EVERYDAY SILVER



CH 6005/10 SB
20W x 20H x 16RH x 5.8RW
PCU : 9



CH 6006/10 SB
31W x 19H x 13RH x 6.5RW
PCU : 12



CH 6016/10 SB
40W x 20H x 14RH x 7.1RW
PCU : 17



CH 6007/10 SB
60W x 20H x 13.5RH x 6.5RW
PCU : 33



CH 6012/10 SB
21W x 41H x 34.5RH x 5RW
PCU : 19



CH 6005/12 SS
20W x 20H x 16R x 5.8RW
PCU : 9



CH 6006/12 SS
31W x 19H x 13RH x 6.5RW
PCU : 12



CH 6016-12 SS
40W x 20H x 14RH x 7.1RW
PCU : 17



CH 6007/12 SS
60W x 20H x 13.5RH x 6.5RW
PCU : 33



CH 6012-12 SS
21W x 41H x 34.5RH x 5RW
PCU : 19



CH 2046/2
15W x 14H x 8RH x 5RW
Box Quantity "281mts"
PCU : 13



CH 2002/2
18W x 20H x 13RH x 6RW
Box Quantity "225mts"
PCU : 20



CH 7003/5
18W x 40H x 35R
Box Quantity "70mts"
PCU : 32



CH 9107-2
18W x 26H x 18RH x 5.3RW
Box Quantity "150mts"
PCU : 14



SC 505-1
20W x 24H x 19RH x 6RWR
Box Quantity "180 mts"
PCU : 25



SC 505-3
20W x 24H x 19RH x 6RWR
Box Quantity "180 mts"
PCU : 25



CH 6005/12 SS
20W x 20H x 16RH x 5.8RW
Box Quantity "150mts"
PCU : 9



CH 6005/10 SB
20W x 20H x 16RH x 5.8RW
Box Quantity "150mts"
PCU : 9



CL 604-3 GUNMETAL
20W x 20H x 16RH x 6.5RW
Box Quantity "179mts"
PCU : 14



CL 604-4 SILVER
20W x 20H x 16RH x 6.5RW
Box Quantity "179mts"
PCU : 14



CH 6012-12 SS
21W x 41H x 34.5RH x 5RW
Box Quantity "70mts"
PCU : 19



CH 6012-10 SB
21W x 41H x 34.5RH x 5RW
Box Quantity "70mts"
PCU : 19



CH 7000 - 3
21W x 17H x 12.5RH x 5.5RW
Box Quantity "220mts"
PCU : 14



CH 7000 - 4
21W x 17H x 12.5RH x 5.5RW
Box Quantity "220mts"
PCU : 14



CH 7000 - 5
21W x 17H x 12.5RH x 5.5RW
Box Quantity "220mts"
PCU : 14



CL 602-2
26W x 22H x 14.5RH x 5.5RW
Box Quantity "133mts"
PCU : 21



CU 4104-2
25.5W x 20.5H x 10RH x 5RW
Box Quantity "115mts"
PCU : 17



IT-9221 ARGENTO
23W x 24H x 14.5RH x 5.5RW
Box Quantity "200mts"
PCE : 36



IT-9221 CHAMPAYNE
23W x 24H x 14.5RH x 5.5RW
Box Quantity "200mts"
PCE : 36



IT-9221 PERTRO
23W x 24H x 14.5RH x 5.5RW
Box Quantity "200mts"
PCE : 36



SC 500-2
25W x 30H x 22R x 6RW
Box Quantity "150 mts"
PCU : 30



DC 1485-2
27W x 22H x 8RH x 6RW
Box Quantity "80mts"
PCU : 18



DC 2405-1
27W x 22H x 8RH x 6RW
Box Quantity "80mts"
PCU : 22



DC 1485-3
27W x 22H x 8RH x 6RW
Box Quantity "80mts"
PCU : 18



CU 4105-2
28W x 29.5H x 18.5RH x 6RW
Box Quantity "69mts"
PCU : 29



ACM 12 MS
31W x 19H x 12RH x 6.5RW
Box Quantity 108mt
Price Code ACM E



CM 300-2
30W x 20H x 11.5RH x 8RW
Box Quantity "100mts"
PCU : 16



CM 740-3 SILVER
30W x 30H x 10RH x 9RW
Box Quantity "80mts"
PCU : 20



CM 387 SILVER
30.5W x 19H x 13RH x 9RW
Box Quantity "131mts"
PCU : 19



CH 7001-4
31W x 20H x 14.5RH
Box Quantity "115mts"
PCU : 21



SC 503-1
31W x 20H x 12RH x 5.8RW
Box Quantity "70 mts"
PCU : 32



CH 6006/12 SS
31W x 19H x 13RH x 6.5RW
Box Quantity "100mts"
PCU : 12



CH 6006/10 SB
31W x 19H x 13RH x 6.5RW
Box Quantity "100mts"
PCU : 12



CH 8000 - 2
31W x 21.5H x 7.5RH
Box Quantity "102mts"
PCU : 20



CH 7001 - 3
31W x 20H x 14.5RH x 6.7RW
Box Quantity "115mts"
PCU : 21



CH 7001 - 5
31W x 20H x 14.5RH x 6.7RW
Box Quantity "115mts"
PCU : 21



CH 9111-2
30W x 22H x 11RH x 7RW
Box Quantity "131mts"
PCU : 21



• APM 590 Platinum
33W x 14H x 9RH x 7RW
Box Quantity "100mts"
PCA : 24
metallic



• APM 590 Silver
33W x 14H x 9RH x 7RW
Box Quantity "100mts"
PCA : 24
metallic



CH 2999-4 SS
33W x 22H x 14RH x 7.3RW
Box Quantity "120mts"
PCU : 20



DC 4642-3
36W x 21.5H x 9.5RH x 7RW
Box Quantity "104mts"
PCU : 24



DC 4642-4
36W x 21.5H x 9.5RH x 7RW
Box Quantity "104mts"
PCU : 24



IT 1100-1050
28W x 24H x 17RH x 6RW
Box Quantity "60mts"
PCE : 17



CH 2001 / 2
37W x 21H x 10RH x 8.2RW
Box Quantity "90mts"
PCU : 34



CM 1241 S
37W x 25.5H x 10.5RH x 5.7RW
Box Quantity "87mts"
PCU : 37



SC 501-2
39W x 21H x 12.5RH x 6RW
Box Quantity "80 mts"
PCU : 37



CH 6016/10 SB
40W x 20H x 14RH x 7.8RW
Box Quantity "80mts"
PCU : 17



CH 6016-12 SS
40W x 20H x 14RH x 7.1RW
Box Quantity "80mts"
PCU : 17



ACM 400 MS
41W x 38H x 12RH x 7RW
Box Quantity 45mt
Price Code ACM R



CH 7002 - 3
41W x 21H x 14.5R x 5.8RW
Box Quantity "91mts"
PCU : 29



CH 9112-2
40W x 29H x 13RH x 7.6RW
Box Quantity "64mts"
PCU : 28



CH 7002 - 5
41W x 21H x 14.5R x 5.8RW
Box Quantity "91mts"
PCU : 29



CH 2084/2
42W x 20.5H x 13RH x 6.2RW
Box Quantity "64mts"
PCU : 32



CM 201 - 415 DAAY
42W x 35H x 25R x 8.2RW
Box Quantity "61mts"
PCU : 34



CM 201-415 DLAP
42W x 35H x 25R x 8.2RW
Box Quantity "61mts"
PCU : 34



CH 8005 - 2
45W x 31.5H x 6.5R x 6.6RW
Box Quantity "74mts"
PCU : 42



ACM 23 SA
45W x 45H x 20RH x 6.5RW
Box Quantity 24mt
Price Code ACM Q



CM 3000 - 4 SS
47W x 22H x 15RH x 7RW
Box Quantity "80mts"
PCU : 29



CH 7002 - 4
41W x 21H x 14.5RH x 5.7RW
Box Quantity "91mts"
PCU : 29



CH 7008 - 4
40W x 22.5H x 10.5RH x 5.8RW
Box Quantity "91mts"
PCU : 32



CU 4106-2
40W x 26.5H x 14RH x 6RW
Box Quantity "57mts"
PCU : 27



CH 2081/2
42W x 15H x 9RH
Box Quantity "99mts"
STOCK:613 M



CU 4103-2
42.5W x 29H x 15RH x 6RW
Box Quantity "46mts"
PCU : 23



DC 1305-7
43W x 21H x 15RH x 6RW
Box Quantity "70mts"
PCU : 31



DC 1486-2
43W x 23H x 10RH x 6.8RW
Box Quantity "70mts"
PCU : 35



CH 8002-2
47W x 56H x 36.6RH x 9.6RW
Box Quantity "30mts"
PCU : 52



CM 750-3 SILVE
48W x 48H x 25RH x 12RW
Box Quantity "40mts"
PCU : 50



DC 1486-3
43W x 23H x 10RH x 6.8RW
Box Quantity "70mts"
PCU : 35



SC 502-2
50W x 24H x 13RH x 7.1RW
Box Quantity "60 mts"
PCU : 47

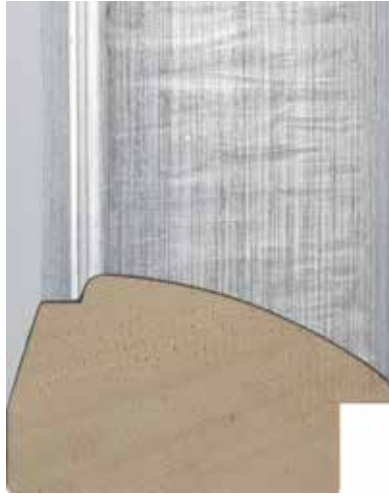

IT-9222 ARGENTO
51W x 29H x 12R x 7RW
Box Quantity "70mts"
PCE : 50



IT-9222 CHAMPAYNE
51W x 29H x 12R x 7RW
Box Quantity "70mts"
PCE : 50



IT-9222 PERTRO
51W x 29H x 12R x 7RW
Box Quantity "70mts"
PCE : 50



CH 8011 - 2
52W x 23H x 16.5R x 10RW
Box Quantity "61mts"
PCU : 32



CH 2019 / 3
52.5W x 20H x 7R x 7.5RW
Box Quantity "86mts"
PCU : 24



CH 2019 / 4
52.5W x 20H x 7RH x 7.5RW
Box Quantity "86mts"
PCU : 24



CH 2085 / 2
52.5W x 25.5H x 16RH x 6.5RW
Box Quantity "55mts"
PCU : 45

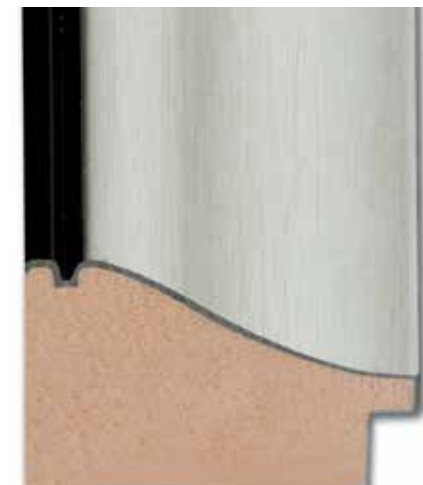

CM 640-4 SBK
53W x 31H x 11RH x 7.9RW
Box Quantity "50mts"
PCU : 36



DC 531 BKSL
51W x 23H x 17RH x 7RW
Box Quantity "70mts"
PCU : 40



CM 605-2
53W x 30H x 12RH x 8.2RW
Box Quantity "50mts"
PCU : 24



CH 9102-1
53W x 37H x 17RH x 7.1RW
Box Quantity "40mts"
PCU : 41

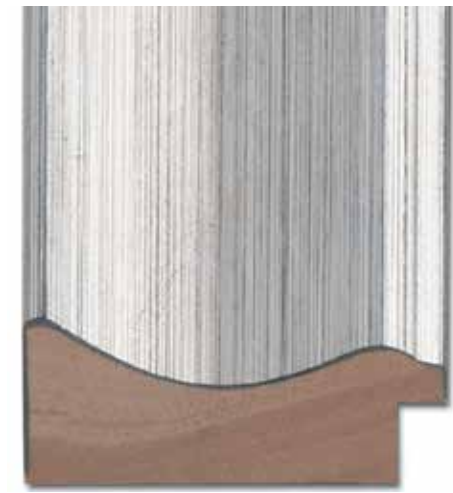

CM 5000 SL
55W x 23H x 11RH x 6.7RW
Box Quantity "70mts"
PCU : 45

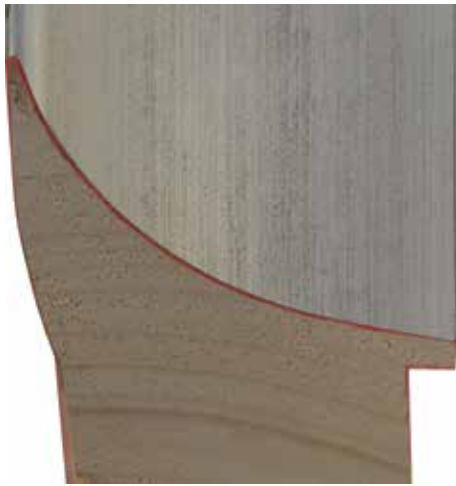

ACM 600 MS
60W x 56H x 18RH x 7RW
Box Quantity 12mt
Price Code ACM W



CH 9113-2
60W x 43H x 26RH x 7.6RW
Box Quantity "28mts"
PCU : 46



CH 6007/12 SS
60W x 20H x 13.5RH x 5RW
Box Quantity "40mts"
PCU : 33



CH 6007/10 SB
60W x 20H x 13.5RH 5RW
Box Quantity "40mts"
PCU : 33



CU 4108-2
60W x 28H x 8RH x RW 7
Box Quantity "40mts"
PCU: 43

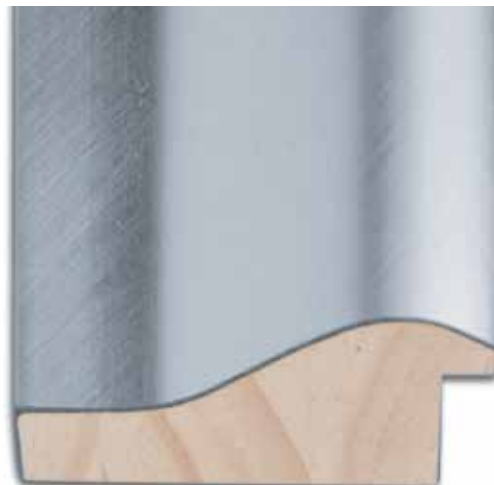

CH 9105-2
65W x 21H x 17RH x 7RW
Box Quantity "50mts"
PCU : 42



CH 2086/2
72W x 30.5H x 18.5RH x 8RW
Box Quantity "42mts"
PCU : 52



ACM 19 SS
76W x 57H x 12.5RH x 8.5RW
Box Quantity 15mt
Price Code ACM V



CU 4107-2
63W x 32H x 11.5RH x 7RW
Box Quantity "34mts"
PCU : 46



IT 1152-1050
71W x 25H x 13.5RH x 8RW
Box Quantity "30mts"
PCE : 53



CM 3001-4 SS
77W x 20H x 11RH x 8RW
Box Quantity "40mts"
PCU : 41



IT 1152-1000
80W x 25.5H x 13RH x 8RW
Box Quantity "30mts"
PCE : 54

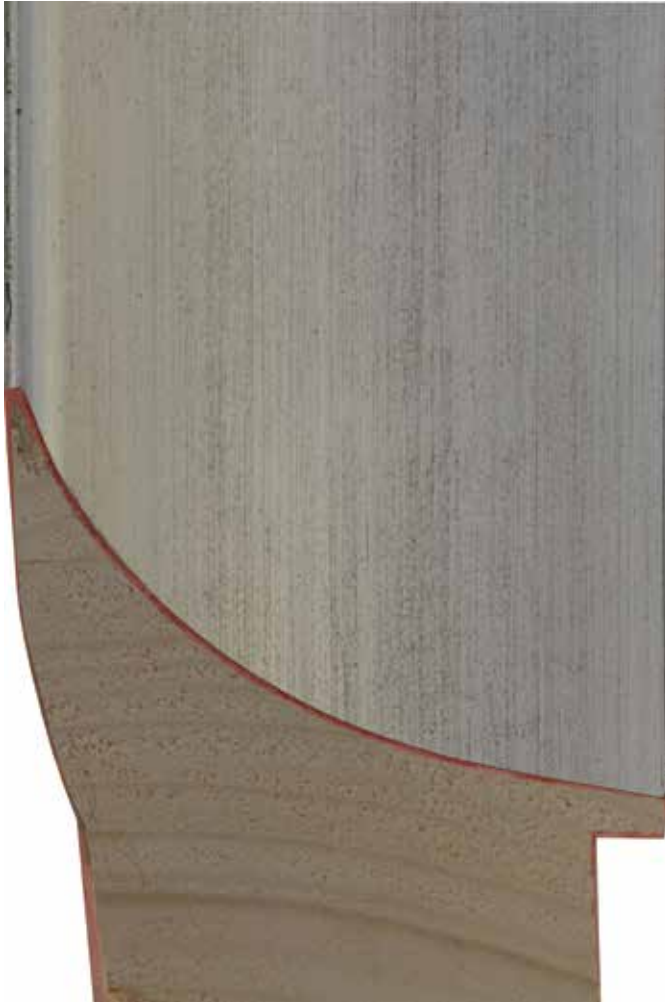

ACM 700 MS
88W x 82H x 26R
Box Quantity 12mt
Price Code ACM AA



ACM 800 SM (below)
91W x 46H x 35RH x 10RW
Box Quantity 12mt
Price Code ACM Z

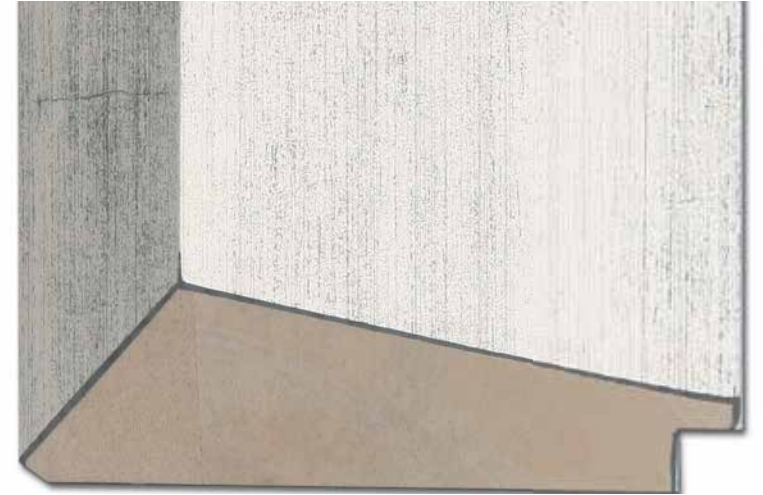

CH 8003 - 2
94W x 28H x 8RH x 7.8RW
Box Quantity "30mts"
PCU : 51

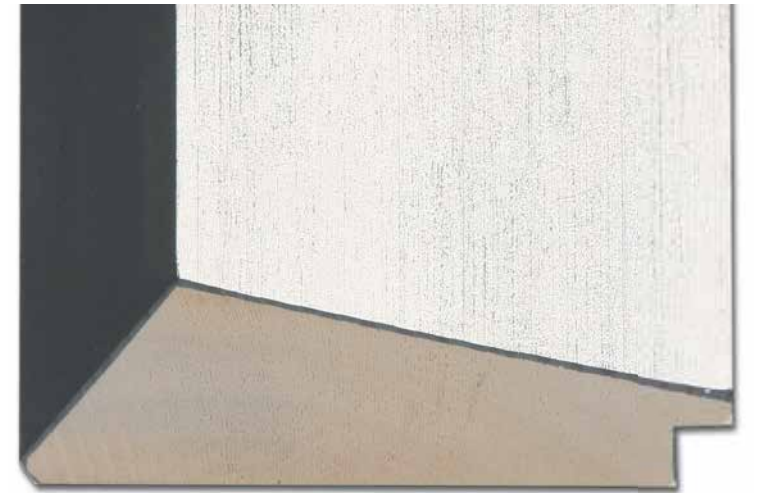

CH 8003 - 4
94W x 28H x 8RH x 7.8RW
Box Quantity "30mts"
PCU : 51

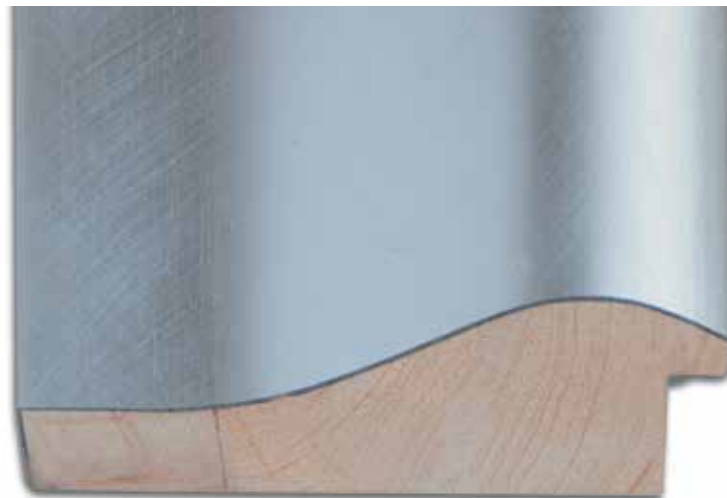

CH 9106-2
94W x 29H x 17RH x 7RW
Box Quantity "30mts"
PCU : 51



CH 8004 - 2
95W x 28H x 10RH x 8.5RW
Box Quantity "33mts"
PCU : 51

EVERYDAY GOLD



CH 6005-9 GB
20W x 20H x 16RH x 5.8RW
PCU : 9



CH 6006/9 GB
31W x 19H x 13RH x 6.5RW
PCU : 19



CH 6016-9 GB
40W x 20H x 14RH x 7.1RW
PCU : 17



CH 6007/9 GB
60W x 20H x 13.5RH x 6.5RW
PCU : 33



CH 6012-9 GB
21W x 41H x 34.5RH x 5RW
PCU : 19



CH 6005/11 SG
20W x 20H x 16RH x 5.8RW
PCU : 9



CH 6006/11 SG
31W x 19H x 13RH x 6.5RW
PCU : 12



CH 6016-11 SG
40W x 20H x 14RH x 7.1RW
PCU : 17



CH 6007/11 SG
60W x 20H x 13.5RH x 6.5RW
PCU : 33



CH 6012-11SG
21W x 41H x 34.5RH x 5RW
PCU : 19



• APM 8 AG
13W x 14H x 10RH x 4.5RW
Box Quantity "430mts"
PCA : 14



CH 2046 / 1
15W x 14H x 8RH x 5RW
Box Quantity "281mts"
PCU : 13



• APM 37 GLBK
16.5W x 17.5H x 8.5RH x 6RW
Box Quantity "259mts"
PCA : 20



• APM 37 GLGR
16.5W x 17.5H x 8.5RH x 6RW
Box Quantity "259mts"
PCA : 23



• APM 37 GLGY
16.5W x 17.5H x 8.5RH x 6RW
Box Quantity "259mts"
PCA : 23



• APM 37 GLPK
16.5W x 17.5H x 8RH x 6RW
Box Quantity "259mts"
PCA : 23



CH 9107-1
18W x 26H x 18RH x 5.3RW
Box Quantity "150mts"
PCU : 14



CH 6005/11 SG
20W x 20H x 16RH x 5.8RW
Box Quantity "150mts"
PCU : 9



CH 6005-9 GB
20W x 20H x 16RH x 5.8RW
Box Quantity "150mts"
PCU : 9



SC 505-1
20Wx 24Hx 19RHx 6RWR
Box Quantity "180 mts"
PCU : 25



CL 604-1 CHAMP
20Wx 20Hx 16RHx 6.5RWR
Box Quantity "179 mts"
PCU : 14



CL 604-2 BRONZ
20Wx 20Hx 16RHx 6.5RWR
Box Quantity "179 mts"
PCU : 14



CH 6012-11 SG
21W x 41H x 34.5RH x 5RW
Box Quantity "60mts"
PCU : 19



CH 6012-9 GB
21W x 41H x 34.5RH x 5RW
Box Quantity "60mts"
PCU : 19



• APM 12 AGBN
22W x 18H x 8.5RH x 6RW
Box Quantity "240mts"
PCA : 24



• APM 12 AGGY
22W x 18H x 8.5RH x 6RW
Box Quantity "240mts"
PCA : 24



CU 4101-1
22W x 18H x 10RH x 4.5RW
Box Quantity "140mts"
PCU : 18



IT-9221 BRONZO
23W x 24H x 14.5RH x 5.5RW
Box Quantity "200mts"
PCE : 36



IT-9221 ORO
23W x 24H x 14.5RHx 5.5RW
Box Quantity "220mts"
PCE : 36



CH 8001-1
24.5W x 34.5H x 27RH x 5.9RW
Box Quantity "60mts"
PCU : 28



SC 500-1
25W x 30H x 22RH x 6RW
Box Quantity "150 mts"
PCU : 30



SC 500-3
25W x 30H x 22RH x 6RW
Box Quantity "150 mts"
PCU : 30



ACM 31 M
26W x 20H x 8RH x 6RW
Box Quantity 144mt
Price Code ACM I



DC 2405-3
27W x 22H x 8RH x 6RW
Box Quantity "130mts"
PCU : 22



DC 2405-2
27W x 22H x 8RH x 6RW
Box Quantity "130mts"
PCU : 22



DC 1485-1
27W x 22H x 8RH x 6RW
Box Quantity "120mts"
PCU : 18



ACM 28 D
30W x 34H x 11RH x 6.5RW
Box Quantity 63mt
Price Code ACM K



CH 6006/11 SG
31W x 19H x 13RH x 6.5RW
Box Quantity "120mts"
PCU : 12



CH 6006/9 GB
31W x 19H x 13RH x 6.5RW
Box Quantity "120mts"
PCU : 12



ACM 12 MG
31W x 19H x 12RH x 6.5RW
Box Quantity 108mt
Price Code ACM E



DC 8000-1
31W x 21.5H x 7.5RH x 7.3RW
Box Quantity "102mts"
PCU : 20



CH 9111-1
30W x 22H x 11RH x 7RW
Box Quantity "120mts"
PCU : 21



CH 7001-2
31W x 20H x 14.5RH x 6.7RW
Box Quantity "120mts"
PCU : 21



CH 2090 / 1
32.5W x 14.5H x 8RH x 7RW
Box Quantity "150mts"
PCU : 21



DC 4642-1
36W x 21.5H x 9.5RH x 7RW
Box Quantity "104mts"
PCU:24



CH 2001 / 1
37W x 21H x 10RH x 8.2RW
Box Quantity "90mts"
PCU : 34



CM 1240 G
37W x 25.5H x 10.5RH x 5.7RW
Box Quantity "87mts"
PCU : 37



SC 501-1
39W x 21H x 12.5RH x 6RW
Box Quantity "80 mts"
PCU : 37



SC 501-3
39W x 21H x 12.5RH x 6RW
Box Quantity "80 mts"
PCU : 37



CH 9112-1
40W x 29H x 13RH x 7.6RW
Box Quantity "70mts"
PCU : 28



CH 7008-2
40W x 22.5H x 10.5RH x 5.8RW
Box Quantity "91mts"
PCU : 32



• APM 9 AGPK
40W x 19H x 10RH x 7RW
Box Quantity "90mts"
PCA : 32



• APM 9 AGBN
40W x 19H x 10RH x 7RW
Box Quantity "90mts"
PCA : 32



• APM 9 AGGY
40W x 19H x 10RH x 7RW
Box Quantity "90mts"
PCA : 32



CH 6016-9 GB
40W x 20H x 14RH x 7.1RW
Box Quantity "90mts"
PCU : 17



CH 6016-11 SG
40W x 20H x 14RH x 7.1RW
Box Quantity "90mts"
PCU : 17



CZ 2540 - 0164
42W x 26H x 15RH x 8RW
Box Quantity "102mts"
PCU : 48



CH 2084 / 1
42W x 20.5H x 13RH x 6.2RW
Box Quantity "64mts"
PCU : 32



CH 2081 / 1
42W x 15H x 9RH x 7RW
Box Quantity "99mts"
PCU : 43



CM 201-415 DAKB
42W x 35H x 25RH x 8.2RW
Box Quantity "61mts"
PCU : 34



CU 4103-1
42.5W x 29H x 15RH x 6RW
Box Quantity "46mts"
PCU : 23



DC 1305-6 GOLD
43W x 21H x 15RH x 6RW
Box Quantity "80mts"
PCU : 31



DC 1486-1
43W x 22H x 10RH x 6.8RW
Box Quantity "80mts"
PCU : 35



CH 9103-2
45W x 22H x 13RH x 7.4RW
Box Quantity "50mts"
PCU : 29



CH 8002-1
47W x 56H x 36.6RH x 9.6RW
Box Quantity "30mts"
PCU : 52



CH 8005-1
45W x 31.5H x 6.5RH x 6.6RW
Box Quantity "74mts"
PCU : 42



ACM 23 C
45W x 45H x 20RH x 6.5RW
Box Quantity 24mt
Price Code ACM Q



DC 327 MBSF
47.5W x 22.5H x 11RH x 5.8RW
Box Quantity "100.6mts"
PCU : 33



DC 327 MYEF
47.5W x 22.5H x 11RH x 5.8RW
Box Quantity "100.6mts"
PCU : 33



ACM 20 C
48W x 36H x 25RH x 6.5RW
Box Quantity 36mt
Price Code ACM P



ACM 20 G
48W x 36H x 25RH x 6.5RW
Box Quantity 36mt
Price Code ACM P



ACM 20 M
48W x 36H x 25RH x 6.5RW
Box Quantity 36mt
Price Code ACM P



SC 502-1
50W x 24H x 13RH x 7.1RW
Box Quantity "60 mts"
PCU : 47



SC 502-3
50W x 24H x 13RG x 7.1RW
Box Quantity "60 mts"
PCU : 47



CS 208 - 1
51.5W x 23H x 8RH x 8.2RW
Box Quantity "55mts"
PCU : 20



ACM 45 GR
51W x 24H x 14RH x 7.5RW
Box Quantity 60mt
Price Code ACM M



IT-9222 BRONZO
51W x 29H x 12RH x 7RW
Box Quantity "70mts"
PCE : 50



IT-9222 ORO
51W x 29H x 12RH x 7RW
Box Quantity "70mts"
PCE : 50



CH 8011-1
52W x 23H x 16.6RH x 10RW
Box Quantity "61mts"
PCU : 32



CH 2005 / 1
52W x 26H x 8RH x 6RW
Box Quantity "65mts"
PCU : 44



CH 2085 / 1
52.5W x 25.5H x 16RH x 6.5RW
Box Quantity "55mts"
PCU : 45



CM 605-1
53W x 30H x 12RH x 8.2RW
Box Quantity "50mts"
PCU : 24



ACM 600 MG
60W x 56H x 18RH x 7RW
Box Quantity 12mt
Price Code ACM W



CM 124 G
60W x 58H x 15RH x 6RW
Box Quantity "78mts"
PCU : 51



CH 2120 G
61W x 38H x 26RH x 7.3RW
Box Quantity "30mts"
PCU : 52



CH 9113-1
60W x 43H x 26RH x 7.6RW
Box Quantity "28mts"
PCU : 46



CH 6007/9 GB
60W x 20H x 13.5RH x 6.5RW
Box Quantity "50mts"
PCU : 33



CH 6007/11 SG
60W x 20H x 13.5RH x 6.5RW
Box Quantity "50mts"
PCU : 33



CH 9104-2
65W x 22H x 13RH x 7.7RW
Box Quantity "45mts"
PCU : 41



DC 799 WYES
70W x 24.5H x 11.5RH x 7.9RW
Box Quantity "60mts"
PCU : 50



CH 2086/1
72W x 30.5H x 18.5RH
Box Quantity "42mts"
PCU : 52



CH 2089/1
73W x 30.5H x 8RH
Box Quantity "40mts"
PCU : 46



CM 3001-1 BG
77W x 20H x 11RH
Box Quantity "60mts"
PCU : 30



CM 3001-3SG
77W x 20H x 11RH
Box Quantity "60mts"
PCU : 30



DC 800 WYES
94W x 31.5H x 13.5RH x 7.8RW
Box Quantity "40mts"
PCU : 54

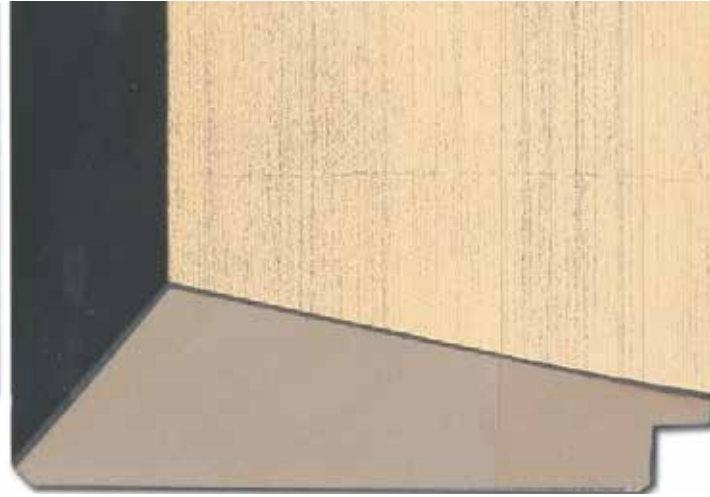

CH 8003 - 3
94W x 28H x 8RH x 7.8RW
Box Quantity "30mts"
PCU : 51



CH 8004 - 1
95W x 28H x 10RH x 8.5RW
Box Quantity "33mts"
PCU : 51



ACM 700 MG
88W x 82H x 26R
Box Quantity 12mt
Price Code ACM AA



ACM 800 GM(on left)
91W x 46H x 35RH x 10RW
Box Quantity 12mt
Price Code ACM Z

CHOP SERVICE

APM offers a chop service on all our mouldings and aluminum within approximately 48 hours.

A chop service has many benefits

- No wastage
- No storage
- No surplus stock
- Hassle free and convenient
- Saves labour cost

To order

Please fax to 03 9387 0455 or

Email christina@apm-mouldings.com.au

Or call Lee 1300 733 018

EVERYDAY TIMBERS



CM 5237 BG
36.5W x 23H x 14RH x 7RW
Box Quantity "104mts"
PCU : 19



CM 5237 BS
36.5W x 23H x 14RH x 7RW
Box Quantity "104mts"
PCU : 19



CM 5248 BS
47.5W x 23H x 13RH x 6.8RW
Box Quantity "70mts"
PCU : 27



CM 5248 BG
47.5W x 23H x 13RH x 6.8RW
Box Quantity "70mts"
PCU : 27



CH 6014 - 2
26W x 21.5H x 11.5RH x 7.2RW
Box Quantity "130mts"
PCU : 13



CH 6014 - 1
26W x 21.5H x 11.5RH x 7.2RW
Box Quantity "130mts"
PCU : 13



CM 720 MBG
29W x 18.5H x 8RH x 6.8RW
Box Quantity "140mts"
PCU : 20



CM 730 MBGL
49W x 20.5H x 9RH x 6.8RW
Box Quantity "70mts"
PCU : 36



APM 408-40 SA
19W x 40H x 34RH x 7RW
Box Quantity "100mts"
PCA : 24



CH 6013 - 1
20W x 60H x 55RH x 5.3RW
Box Quantity "66mts"
PCU : 45



CH 6019-1
14W x 14H x 9.5RH x 5.2RW
Box Quantity "210mts"
PCU : 10



CH 6019-2
14W x 14H x 9.5RH x 5.2RW
Box Quantity "210mts"
PCU : 10



CL 600-1
15W x 20H x 15RH x 6RW
Box Quantity "175mts"
PCU : 13



SC 5027
16W x 33H x 27RH x 6.5RW
Box Quantity "200 mts"
PCU : 31
VENEER



SC 5017
19W x 38H x 32RH x 6.5RW
Box Quantity "200 mts"
PCU : 36
VENEER



SC 5026
19W x 50H x 44RH x 7RW
Box Quantity "150 mts"
PCU : 42
VENEER



APM 408 ECAMEL
19W x 27H x 22RH x 6RW
Box Quantity "144mts"
PCA : 19



APM 408 ECASHEW
19W x 27H x 22RH x 6RW
Box Quantity "144mts"
PCA : 19



APM 408 EOATMEAL
19W x 27H x 22RH x 6RW
Box Quantity "144mts"
PCA : 19



APM 408 ESNOWGUM
19W x 27H x 22RH x 6RW
Box Quantity "144mts"
PCA : 19



APM 408 RGY
19W x 27H x 22RH x 6RW
Box Quantity "144mts"
PCA : 19



CH 6005 / 1
20W x 21H x 16RH x 5.8RW
Box Quantity "210mts"
PCU : 8



CH 6005 / 2
20W x 21H x 16RH x 5.8RW
Box Quantity "210mts"
PCU : 8



CH 6012 / 1 CLEA
20W x 40H x 35.5RH x 6.8RW
Box Quantity "113mts"
PCU : 29



CH 6012 / 2 LIGH
20W x 40H x 35.5RH x 6.8RW
Box Quantity "113mts"
PCU : 29



APM 150 ECAMEL
25W x 40H x 15RH x 7RW
Box Quantity "50mts"
PCA : 28



APM 150 ECASHEW
25W x 40H x 15RH x 7RW
Box Quantity "50mts"
PCA : 28



APM 152 ECAMEL
25W x 60H x 15RH x 7RW
Box Quantity "40mts"
PCA : 42



CL 601-4
19W x 28H x 22RH x 7RW
Box Quantity "160mts"
PCU : 19



APM 1 CASHEW
19W x 40H x 35RH x 6RW
Box Quantity "70mts"
PCA : 41



APM 408-40 CAS
19W x 40H x 34RH x 6.5RW
Box Quantity "100mts"
PCA : 30



APM 1 ZEBRANO
19W x 40H x 35RH x 6RW
Box Quantity "70mts"
PCA : 41



APM 1 COYOTE
19W x 40H x 35RH x 6RW
Box Quantity "70mts"
PCA : 41



APM 24 CASHEW
19W x 41H x 12RH x 6RW
Box Quantity "50mts"
PCA : 40



APM 24 ZEBRANO
19W x 41H x 12RH x 6RW
Box Quantity "50mts"
PCA : 40



APM 24 COYOTE
19W x 41H x 12RH x 6RW
Box Quantity "50mts"
PCA : 40



APM 407 CASHEW
20W x 22H x 16RH x 6.5RW
Box Quantity "140mts"
PCA : 21



APM 407 ZEBRA
20W x 22H x 16RH x 6.5RW
Box Quantity "140mts"
PCA : 21



APM 407 COYOT
20W x 22H x 16RH x 6.5RW
Box Quantity "140mts"
PCA : 21



IT 2317 GRIGIO
25W x 20H x 12RH x 5RW
Box Quantity "220mts"
PCE : 30



IT 2317 NATURA
25W x 20H x 12RH x 5RW
Box Quantity "220mts"
PCE : 30



IT 2317 NOCE
25W x 20H x 12RH x 5RW
Box Quantity "220mts"
PCE : 30



OP2213 3GREY
23W x 13H x 9.5RH x 5RW
Box Quantity "400mts"
PCU : 4



OP2213 4WAL
23W x 13H x 9.5RH x 5RW
Box Quantity "400mts"
PCU : 4



IT215 NATURALE
25W x 23H x 17RH x 6RW
Box Quantity "200mts"
PCE : 36



IT215 BIANCO
25W x 23H x 17RH x 6RW
Box Quantity "200mts"
PCE : 36



IT215 GRIGIO
25W x 23H x 17RH x 6RW
Box Quantity "200mts"
PCE : 36



IT215 NOCE
25W x 23H x 17RH x 6RW
Box Quantity "200mts"
PCE : 36



APM 152 ECASHEW
25W x 60H x 15RH x 7RW
Box Quantity "40mts"
PCA : 42



APM 152 EOATMEAL
25W x 60H x 15RH x 7RW
Box Quantity "40mts"
PCA : 42



APM 152 ESNOW
25W x 60H x 15RH x 7RW
Box Quantity "40mts"
PCA : 42



APM 152 RGY
25W x 60H x 15RH x 7RW
Box Quantity "40mts"
PCA : 42



APM 422 ERGY
30W x 19H x 13RH x 7RW
Box Quantity "100mts"
PCA : 19



APM 422 ECAMEL
30W x 19H x 13RH x 7RW
Box Quantity "100mts"
PCA : 19



APM 422 ECASHEW
30W x 19H x 13RH x 7RW
Box Quantity "100mts"
PCA : 19



APM 422 EOATMEAL
30W x 19H x 13RH x 7RW
Box Quantity "100mts"
PCA : 19



APM 422 ESNOWGUM
30W x 19H x 13RH x 7RW
Box Quantity "100mts"
PCA : 19



APM 422 EMULBERRY
30W x 19H x 13RH x 7RW
Box Quantity "100mts"
PCA : 19



CH 6006 / 1
31W x 22H x 17RH x 5.5RW
Box Quantity "120mts"
PCU: 11



CH 6006 / 2 HONEY
31W x 22H x 17RH x 5.5RW
Box Quantity "120mts"
PCU: 11



APM 3409 W
32W x 20H x 10.5RH x 7RW
Box Quantity "120mts"
PCA : 20



APM 344 W
32W x 20H x 8RH x 7RW
Box Quantity "100mts"
PCA : 19



APM 3409 WG
32W x 20H x 10.5RH x 7RW
Box Quantity "120mts"
PCA : 20



APM 153 TBN
32W x 18H x 10RH x 7RW
Box Quantity "120mts"
PCA : 18



APM 870 T
32W x 20H x 9RH x 7RW
Box Quantity "100mts"
PCA : 22



APM 604 ECAMEL
32W x 32H x 23RH x 7RW
Box Quantity "100mts"
PCA : 23



APM 604 ECASHEW
32W x 32H x 23RH x 7RW
Box Quantity "100mts"
PCA : 23



APM 422-1
30W x 19H x 13RH x 7.5RW
Box Quantity "100mts"
PCA : 17



APM 422-2
30W x 19H x 13RH x 7.5RW
Box Quantity "100mts"
PCA : 17



APM 422-3
30W x 19H x 13RH x 7.5RW
Box Quantity "100mts"
PCA : 17



APM 422-4
30W x 19H x 13RH x 7.5RW
Box Quantity "100mts"
PCA : 17



APM 422-5
30W x 19H x 13RH x 7.5RW
Box Quantity "100mts"
PCA : 17



APM 152 COYOTE
25.5W x 60H x 15RH x 7.5RW
Box Quantity "50mts"
PCA : 42



APM 4043 CASHEW
30W x 42H x 12RH x 7RW
Box Quantity "50mts"
PCA : 46



APM 4043 ZEBRANO
30W x 42H x 12RH x 7RW
Box Quantity "50mts"
PCA : 46



APM 4043 COYOTE
30W x 42H x 12RH x 7RW
Box Quantity "50mts"
PCA : 46



CL603 1
32W x 20H x 15RH x 7RW
Box Quantity "104mts"
PCU : 19



APM402 CLEAR
30W x 19H x 13RH x 7RW
Box Quantity "100mts"
PCA: 24



IT216 NOCE
36W x 35H x 28RH x 7.5RW
Box Quantity "100mts"
PEC : 46



IT216 NATURAL
36W x 35H x 28RH x 7.5RW
Box Quantity "100mts"
PCE : 46



IT216 GRIGIO
36W x 35H x 28RH x 7.5RW
Box Quantity "100mts"
PCE : 46



IT216 BIANCO
36W x 35H x 28RH x 7.5RW
Box Quantity "100mts"
PCE : 46



CH 6016-1
40W x 20H x 9RH x 6.8RW
Box Quantity "110mts"
PCU : 15



CH 6016-2
40W x 20H x 9RH x 6.8RW
Box Quantity "150mts"
PCU : 15



CU 42 CLEAR
40W x 20H x 14.5RH x 7RW
Box Quantity "63mts"
PCU : 21



APM 425 WG
41W x 20H x 8RH x 7RW
Box Quantity "80mts"
PCA : 33



APM 105 AW
42W x 20H x 9RH x 7RW
Box Quantity "90mts"
PCA : 23



APM 609 W
42W x 19H x 10.5RH x 7RW
Box Quantity "90mts"
PCA : 21



APM 704 ECAMEL
42W x 35H x 25RH x 7RW
Box Quantity "48mts"
PCA : 30



APM 704 ECASHEW
42W x 35H x 25RH x 7RW
Box Quantity "48mts"
PCA : 30



APM 704 EMULBERRY
42W x 35H x 25RH x 7RW
Box Quantity "48mts"
PCA : 30



APM 704 EOATMEAL
42W x 35H x 25RH x 7RW
Box Quantity "48mts"
PCA : 30



APM 704 RGY
42W x 35H x 25RH x 7RW
Box Quantity "48mts"
PCA : 30



APM 704 ESNOWGUM
42W x 35H x 25RH x 7RW
Box Quantity "48mts"
PCA : 30



APM 174 GO
42W x 20H x 11.5RH x 7RW
Box Quantity "90mts"
PCA : 24



APM174 W
42W x 20H x 11.5RH x 7RW
Box Quantity "90mts"
PCA : 24



APM174 WG
42W x 20H x 11.5RH x 7RW
Box Quantity "90mts"
PCA : 24



APM 120 A/T
42W x 19H x 9RH x 7RW
Box Quantity "90mts"
PCA : 23



APM H100 CLEAR
42W x 18H x 9RH x 7RW
Box Quantity "90mts"
PCA : 17



APM 704 W
42W x 35H x 25RH x 7RW
Box Quantity "48mts"
PCA : 30



APM 871 TS
42W x 20H x 9RH x 7RW
Box Quantity "70mts"
PCA : 34



APM 871 TG
42W x 20H x 9RH x 7RW
Box Quantity "70mts"
PCA : 34



APM 871 T
42W x 20H x 9RH x 7RW
Box Quantity "70mts"
PCA : 34



APM 56 W
43W x 20H x 11RH x 7RW
Box Quantity "85mts"
PCA : 28



APM 3509 WG
42W x 20H x 8RH x 7RW
Box Quantity "90mts"
PCA : 22



APM 3509 W
42W x 20H x 8RH x 7RW
Box Quantity "90mts"
PCA : 22



APM 3509 GO
42W x 20H x 8RH x 7RW
Box Quantity "90mts"
PCA : 22



APM 3509 GOG
42W x 20H x 8RH x 7RW
Box Quantity "90mts"
PCA : 22



APM 569 RIVERS
42W x 33H x 14RH x 7RW
Box Quantity "72mts"
PCA : 24



APM 569 GR TEA
42W x 33H x 14RH x 7RW
Box Quantity "72mts"
PCA : 24



APM 569 OATM
42W x 33H x 14RH x 7RW
Box Quantity "72mts"
PCA : 24



APM 569 MULB
42W x 33H x 14RH x 7RW
Box Quantity "72mts"
PCA : 24



APM 569 SNOW
42W x 33H x 14RH x 7RW
Box Quantity "72mts"
PCA : 24



CH 6008 - 2
48W x 19H x 12RH x 6.8RW
Box Quantity "72mts"
PCU : 26



APM 610 W
52W x 19H x 10.5RH x 7RW
Box Quantity "72mts"
PCA : 23



IT 2318 GRIGIO
50W x 25H x 15RH x 10RW
Box Quantity "80mts"
PCE : 47



IT 2318 NATURA
50W x 25H x 15RH x 10RW
Box Quantity "80mts"
PCE : 47



IT 2318 NOCE
50W x 25H x 15RH x 10RW
Box Quantity "80mts"
PCE : 47



APM 3609 JG
56W x 20H x 9RH x 7RW
Box Quantity "60mts"
PCA : 33



APM 121 WALNUT
57W x 20H x 10RH x 7RW
Box Quantity "72mts"
PCA : 28



APM 121 TBN
57W x 20H x 10RH x 7RW
Box Quantity "72mts"
PCA : 28



CH 6007 - 2
61W x 20H x 14RH x 7RW
Box Quantity "66mts"
PCU : 34



CH 6007 - 1
61W x 20H x 14RH x 7RW
Box Quantity "66mts"
PCU : 34



APM 102 GREEN
64W x 19H x 12.5RH x 7RW
Box Quantity "72mts"
PCA : 36



APM 706 ECASH
64W x 19H x 12.5RH x 7RW
Box Quantity "72mts"
PCA : 36



APM 706 ECAMEL
64W x 19H x 12.5RH x 7RW
Box Quantity "72mts"
PCA : 36



APM 706 ERGY
64W x 19H x 12.5RH x 7RW
Box Quantity "72mts"
PCA : 36



APM 706 ESNOGWUM
64W x 19H x 12.5RH x 7RW
Box Quantity "72mts"
PCA : 36



APM 706 EMULBERRY
64W x 19H x 12.5RH x 7RW
Box Quantity "72mts"
PCA : 36



APM 706 EOATMEAL
64W x 19H x 12.5RH x 7RW
Box Quantity "72mts"
PCA : 36

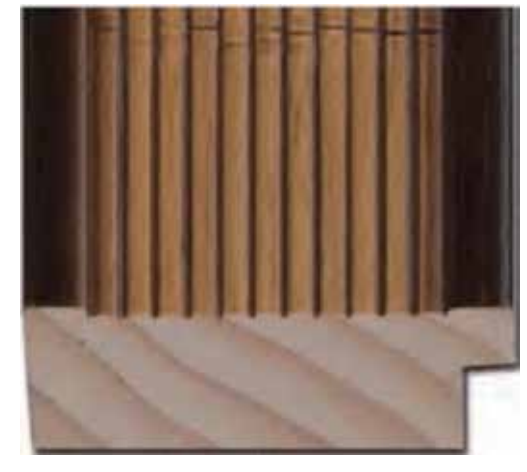

APM 920-1
64W x 20H x 12RH
Box Quantity "54mts"
STOCK:682 M



APM 920-2
64W x 20H x 12RH
Box Quantity "54mts"
STOCK:881 M



APM 268 W
65W x 20H x 10RH x 7RW
Box Quantity "60mts"
PCA : 35



APM 80 EWG
65W x 28H x 16RH
Box Quantity "36mts"
STOCK:371 M



APM 570 GREEN
66W x 32H x 15RH x 7RW
Box Quantity "40mts"
PCA : 42



APM 570 MULBER
66W x32H x 15RH x 7RW
Box Quantity "40mts"
PCA : 42



APM 570 SNOW
66W x32H x 15RH x 7RW
Box Quantity "40mts"
PCA : 42



APM 570 OATMEAL
66W x32H x 15RH x 7RW
Box Quantity "40mts"
PCA : 42



APM 570 RIVER
66W x32H x 15RH x 7RW
Box Quantity "40mts"
PCA : 42

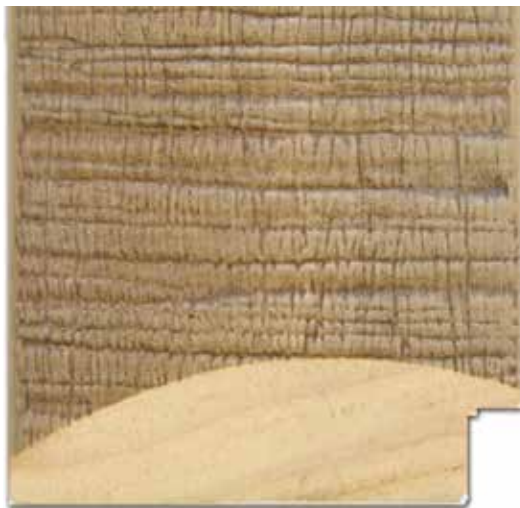

APM 611 EOATM
68W x19H x 12.5RH x 7RW
Box Quantity "63mts"
PCA : 31



APM 611 RGY
68W x19H x 12.5RH x 7RW
Box Quantity "63mts"
PCA : 31



SC 7818 W
92W x 34H x 11RH x 8.6RW
Box Quantity "30mts"
PCU : 57



APM 873 TG
70W x20H x 9RH x 7RW
Box Quantity "60mts"
PCA : 42



APM 873 T
70W x20H x 9RH x 7RW
Box Quantity "60mts"
PCA : 42

FREE DELIVERY

ALL STATES

ALL AREAS

AUSTRALIA WIDE

FOR ORDERS

OVER \$500* EXCLUDING GST

* CONDITIONS APPLY-EXCLUDING CUSTOMERS
WITH PRIOR ARRANGEMENTS
Excluding mirrors, glass and machinery

EVERYDAY TIMBERS



CM 370 FRDBR
59W x 20H x 13.5RH x 6.7RW
Box Quantity "37mts"
PCU : 35



CM 369 FRDBR
40W x 20H x 13.5RH x 7RW
Box Quantity "90mts"
PCU : 20



CM 387 FRDBR
31W x 19H x 13RH x 7RW
Box Quantity "100mts"
PCU : 14



CM 720 MT
29W x 18.5H x 8RH x 6RW
Box Quantity "140mts"
PCU : 18



CM 720 YT
29W x 18.5H x 8RH x 6RW
Box Quantity "140mts"
PCU : 18



CM 730 MT
49W x 20.5H x 9RH x 7RW
Box Quantity "70mts"
PCU : 28



CM 730 YT
49W x 20.5H x 9RH x 7RW
Box Quantity "70mts"
PCU : 28



CCF 409 1YT
38W x 20H x 10RH x 6.7RW
Box Quantity "100mts"
PCU : 20



CCF 409 2MT
38W x 20H x 10RH x 6.7RW
Box Quantity "100mts"
PCU : 20



APM 4020 NB
13W x 20H x 15RH x 5RW
Box Quantity "250mts"
PCA : 17



OP 1320 ESP
13W x 20H x 15RH x 5RW
Box Quantity "400mts"
PCU : 9



CM 923 GL
13W x 15.5H x 9RH x 6RW
Box Quantity "450mts"
PCU : 14



CH 6019-3
14W x 14H x 9.5RH x 8RW
Box Quantity "200mts"
PCU : 10



CH 6019-4
14W x 14H x 9.5RH x 8RW
Box Quantity "200mts"
PCU : 10



CH 6019-6
14W x 14H x 9.5RH x 8RW
Box Quantity "200mts"
PCU : 10



CL 600-2
15W x 20H x 15RH x 6RW
Box Quantity "175mts"
PCA : 13



CL 600-3
15W x 20H x 15RH x 6RW
Box Quantity "175mts"
PCA : 13



APM 711 RED
16W x 19H x 6RH x 6RW
Box Quantity "120mts"
PCA : 13



APM 711 NAVY
16W x 19H x 6RH x 6RW
Box Quantity "120mts"
PCA : 13



CM 293 YT
18.5W x 12.5H x 6RH x 4.5RW
Box Quantity "180mts"
PCU : 13



CM 293 MT
18.5W x 12.5H x 6RH x 4.5RW
Box Quantity "180mts"
PCU : 13



APM 408 RDW
19W x 27H x 22RH x 6RW
Box Quantity "144mts"
PCA : 19



CL 601-1
19W x 28H x 22RH x 7RW
Box Quantity "160mts"
PCU : 19



OP1938ESP
19.5W x 38.5H x 31RH x 7RW
Box Quantity "88mts"
PCU : 17



APM 408-40 MOC
19W x 40H x 34RH x 7RW
Box Quantity "80mts"
PCA : 38



APM 408-40 NB
19W x 40H x 34RH x 7RW
Box Quantity "80mts"
PCA : 38



APM 407 WENGE
20W x 22H x 16RH x 6.5RW
Box Quantity "140mts"
PCA : 21



CH 6005 / 3
20W x 21H x 16RH x 5.8RW
Box Quantity "210mts"
PCU : 8



CH 6005 / 4
20W x 21H x 16RH x 5.8RW
Box Quantity "210mts"
PCU : 8



CH 6005 / 6
20W x 21H x 16RH x 5.8RW
Box Quantity "210mts"
PCU : 8



CH 6012 - 3
20W x 40H x 35.5RH x 5.5RW
Box Quantity "113mts"
PCU : 29



CH 6012 - 4
20W x 40H x 35.5RH x 5.5RW
Box Quantity "113mts"
PCU : 29



CH 6012 - 6
20W x 40H x 35.5RH x 5.5RW
Box Quantity "113mts"
PCU : 29



APM 163 BRL
20W x 15H x 9.5RH x 6RW
Box Quantity "240mts"
PCA : 21



APM 163 BRLG
20W x 15H x 9.5RH x 6RW
Box Quantity "240mts"
PCA : 21



DC 1310 - 1
21W x 29H x 22RH x 5.7RW
Box Quantity "140mts"
PCA : 20



DC 1310 - 2
21W x 29H x 22RH x 5.7RW
Box Quantity "140mts"
PCA : 20



CH 6013 - 4
20W x 60H x 55RH x 5.5RW
Box Quantity "66mts"
PCU : 45



CH 6013 - 3
20W x 60H x 55RH x 5.5RW
Box Quantity "66mts"
PCU : 45



CM 838 YT
22.5W x 18.5H x 8RH x 6RW
Box Quantity "211mts"
PCU : 18



CM 839 MT
22.5W x 18.5H x 8RH x 6RW
Box Quantity "211mts"
PCU : 18



CH 6017 - 6
22.5W x 22H x 12RH x 5.5RW
Box Quantity "200mts"
PCU : 11



CH 6017-5
22.5W x 22H x 12RH
Box Quantity "200mts"
PCU : 11



CL 2789 BROWN
24W x 29H x 15RH x 5.5RW
Box Quantity "75mts"
PCU : 20



CL 2789 GRAY
24W x 29H x 15RH x 5.5RW
Box Quantity "75mts"
PCU : 20



OP 2213 - 5 ESP
23W x 13H x 9.5RH x 5RW
Box Quantity "400mts"
PCU : 4



APM 150 RDW
25W x 40H x 15RH x 7RW
Box Quantity "50mts"
PCA : 28



APM 152 RDW
25W x 60H x 15RH x 7RW
Box Quantity "40mts"
PCA : 42



APM 152 WENGE
25.5W x 60H x 15RH x 7.5RW
Box Quantity "50mts"
PCA : 42



APM 21 BMG
26W x 15H x 7RH x 7RW
Box Quantity "168mts"
PCA : 18



APM 700 DW
26W x 32H x 11RH x 6.5RW
Box Quantity "72mts"
PCA : 18



APM 700 NB
26W x 32H x 11RH x 6.5RW
Box Quantity "72mts"
PCA : 18



APM 4042 NB
28W x 45H x 40RH x 7RW
Box Quantity "60mts"
PCA : 47



CM 720 MT
29W x 18.5H x 8RH x 6RW
Box Quantity "140mts"
PCU : 18



CM 720 YT
29W x 18.5H x 8RH x 6RW
Box Quantity "140mts"
PCU : 18



OP 3017 ESP
30W x 17H x 12RH x 6RW
Box Quantity "160mts"
PCU : 14



• APM 422 ERDW
30W x 19H x 13RH x 7RW
Box Quantity "100mts"
PCA : 19



CM 387 FRDBR
31W x 19H x 13RH x 7RW
Box Quantity "100mts"
PCU : 11



CM 387 DRED
31W x 19H x 13RH x 7RW
Box Quantity "131mts"
PCU : 11



CM 387 DBR
31W x 19H x 13RH x 7RW
Box Quantity "131mts"
PCU : 11



APM 402 CHARCOAL
30W x 20H x 13RH x 6RW
Box Quantity "120mts"
PCA : 24



APM 402 MOCCA
30W x 20H x 13RH x 6RW
Box Quantity "120mts"
PCA : 24



APM 4043 WENGE
30W x 42H x 12RH x 7RW
Box Quantity "50mts"
PCA : 46



CH 6006/3
31W x 20H x 17RH x 5.5RW
Box Quantity "120mts"
PCU : 11



CH 6006/4
31W x 20H x 17RH x 5.5RW
Box Quantity "120mts"
PCU : 11



CH 6006/6
31W x 20H x 17RH x 5.5RW
Box Quantity "120mts"
PCU : 11



OP 3125 ESP
31W x 25H x 19RH x 6.5RW
Box Quantity "120mts"
PCU : 18



APM 6006 AQUA
31W x 22H x 17RH x 5.5RW
Box Quantity "100mts"
PCA : 17



APM 6006 BBL
31W x 22H x 17RH x 5.5RW
Box Quantity "100mts"
PCA : 17



APM 6006 CYL
31W x 22H x 17RH x 5.5RW
Box Quantity "100mts"
PCA : 17



APM 6006 DBL
31W x 22H x 17RH x 5.5RW
Box Quantity "100mts"
PCA : 17



APM 6006 FP
31W x 22H x 17RH x 5.5RW
Box Quantity "100mts"
PCA : 17



APM 6006 MUST
31W x 22H x 17RH x 5.5RW
Box Quantity "100mts"
PCA : 17



APM 6006 PETALPINK
31W x 22H x 17RH x 5.5RW
Box Quantity "100mts"
PCA : 17



APM 6006 RR
31W x 22H x 17RH x 5.5RW
Box Quantity "100mts"
PCA : 17



APM 6006 TERRA
31W x 22H x 17RH x 5.5RW
Box Quantity "100mts"
PCA : 17



APM 870 M
32W x 20H x 9RH x 5.5RW
Box Quantity "110mts"
PCA : 22



IT-6016-1760
38W x 20.5H x 15RH x 7RW
Box Quantity "80mts"



CL 603 - 2
32W x 20H x 9RH x 7RW
Box Quantity "100mts"
PCA : 22



APM 320 ASHWOOD
32W x 20H x 9RH x 7RW
Box Quantity "100mts"
PCA : 22



APM 320 NB
32W x 20H x 9RH x 7RW
Box Quantity "100mts"
PCA : 22



APM 3409 MT
32W x 20H x 10.5RH
Box Quantity "120mts"
PCA : 20



APM 3409 DW
32W x 20H x 10.5RH
Box Quantity "120mts"
PCA : 20



APM 3409 DWG
32W x 20H x 10.5RH
Box Quantity "120mts"
PCA : 20



APM 608 NB
32W x 12.5H x 6.5RH
Box Quantity "105mts"
PCA : 17



APM 608 DW
32W x 12.5H x 6.5RH
Box Quantity "105mts"
PCA : 17



APM 153 MBN
32W x 18H x 10RH
Box Quantity "120mts"
PCA : 18



APM 108 AMBL
32W x 19H x 12RH
Box Quantity "120mts"
PCA : 16



APM 604 RDW
32W x 32H x 23RH x 7RW
Box Quantity "50mts"
PCA : 23



APM 989 MOCCA
34W x 30H x 25RH x 9RW
Box Quantity "100mts"
PCA : 25



APM 2 BRLG
32W x 15H x 8RH x 7RW
Box Quantity "130mts"
PCA : 23



APM 108 AW
32W x 19H x 12RH
Box Quantity "120mts"
PCA : 16



APM 106 EANW
32W x 20H x 6RH
Box Quantity "144mts"
PCA : 35



GG 31 - 1
32.5W x 19.5H x 14RH x 7RW
Box Quantity "190mts"
PCU : 12



GG 31 - 2
32.5W x 19.5H x 14RH x 7RW
Box Quantity "190mts"
PCU : 12



GG 31 - 3
32.5W x 19.5H x 14RH x 7RW
Box Quantity "190mts"
PCU : 12



CH6003/2
35W x 21H x 11RH
Box Quantity "108mts"
PCU : 36



CH6003/4
35W x 21H x 11RH
Box Quantity "108mts"
PCU : 36



APM 3505 MBN
37W x 19H x 9RH
Box Quantity "108mts"
PCA : 24



IT-6016-1730
38W x 20.5H x 15RH x 7RW
Box Quantity "80mts"



SC 504-1
36W x 30H x 15.5RH x 5.8RW
Box Quantity "90 mts"
PCU : 39



SC 504-2
36W x 30H x 15.5H x 5.8RWR
Box Quantity "90 mts"
PCU : 39



SC 504-3
36W x 30H x 15.5RH x 5.8RWR
Box Quantity "90 mts"
PCU : 39



SC 506-1
34W x 30H x 24RH x 7RW
Box Quantity "45 mts"
PCU : 45
VENEER



CCF 409 1YT
38W x 20H x 10RH x 6.7RW
Box Quantity "100mts"
PCU : 18



CCF 409 2MT
38W x 20H x 10RH x 6.7RW
Box Quantity "100mts"
PCU : 18



CM 369 FRDBR
40W x 20H x 13.5RH x 7RW
Box Quantity "131mts"
PCU : 15



CH 6016-3
40W x 20H x 9RH x 6.8RW
Box Quantity "150mts"
PCU : 15



CH 6016-6
40W x 20H x 9RH x 6.8RW
Box Quantity "150mts"
PCU : 15



CH 7008 - 1
40W x 22.5H x 10.5RH
Box Quantity "91mts"
PCU : 32



APM 9 BMG
40W x 19H x 10RH x 7RW
Box Quantity "90mts"
PCA : 32



CL 4118 BROWN
41W x 27H x 13RH x 6.5RW
Box Quantity "58mts"
PCU : 37



CL 4118 GREY
41W x 27H x 13RH x 6.5RW
Box Quantity "58mts"
PCU : 37



GG 4134 - 1
41W x 35H x 27RH x 7RW
Box Quantity "46mts"
PCU : 34



GG 4134 - 2
41W x 35H x 27RH x 7RW
Box Quantity "46mts"
PCU : 34



GG 4134 - 3
41W x 35H x 27RH x 7RW
Box Quantity "46mts"
PCU : 34



APM 845 NBS
42W x 19H x 9.5RH
Box Quantity "90mts"
PCA: 19



SC 508-1
41W x 27H x 11RH x 7RW
Box Quantity "50 mts"
PCU : 46
VENEER



SC 508-2
41W x 27H x 11RH x 7RW
Box Quantity "50 mts"
PCU : 46
VENEER



APM 506 DWBK
42W x 19H x 8RH x 7RW
Box Quantity "90mts"
PCA : 21



APM 845 NB
42W x 19H x 9.5RH x 7RW
Box Quantity "90mts"
PCA : 23



APM 910 - 5
42W x 20H x 14RH x 7RW
Box Quantity "90mts"
PCA : 36



APM 569 ONYX
42W x 33H x 14RH x 7RW
Box Quantity "65mts"
PCA : 24



APM 704 DW
42W x 35H x 25RH x 7RW
Box Quantity "48mts"
PCA : 30



APM 704 NB
42W x 35H x 25RH x 7RW
Box Quantity "48mts"
PCA : 30



APM 704 RDW
42W x 35H x 25RH x 7RW
Box Quantity "50mts"
PCA : 30



APM 3509 DW
42W x 20H x 8RH x 7RW
Box Quantity "90mts"
PCA : 22



APM 3509 DWG
42W x 20H x 8RH x 7RW
Box Quantity "90mts"
PCA : 22



APM 3509 NB
42W x 20H x 8RH x 7RW
Box Quantity "90mts"
PCA : 22



APM 3509 MT
42W x 20H x 8RH x 7RW
Box Quantity "90mts"
PCA : 22



APM 609 NB
42W x 19H x 10.5RH x 7RW
Box Quantity "90mts"
PCA : 21



APM 609 DW
42W x 19H x 10.5RH x 7RW
Box Quantity "90mts"
PCA : 21



APM 506 WBK
42W x 19H x 8RH x 7RW
Box Quantity "60mts"
PCA : 25



APM 120 AAN
42W x 19H x 9RH x 7RW
Box Quantity "90mts"
PCA : 23



APM 103 WBK
42W x 20H x 12RH x 7RW
Box Quantity "90mts"
PCA : 38



APM 871 M
42W x 20H x 9RH x 7RW
Box Quantity "90mts"
PCA : 34



APM 871 MG
42W x 20H x 9RH x 7RW
Box Quantity "90mts"
PCA : 34



APM 871 MS
42W x 20H x 9RH x 7RW
Box Quantity "90mts"
PCA : 34



DC 1305 - 1
42W x 21H x 16RH x 6RW
Box Quantity "100mts"
PCU : 40



DC 1305 - 2
42W x 21H x 16RH x 6RW
Box Quantity "100mts"
PCU : 40



DC 1305 - 3
42W x 21H x 16RH x 6RW
Box Quantity "100mts"
PCU : 40



DC 1305 - 4
42W x 21H x 16RH x 6RW
Box Quantity "100mts"
PCU : 40



DC 1305 - 5
42W x 21H x 16RH x 6RW
Box Quantity "100mts"
PCU : 40



APM 139 A / W
43W x 20H x 8RH x 6RW
Box Quantity "108mts"
PCA : 24



DC 867-3 TEAK
44W x 21H x 15RH x 7RW
Box Quantity "87mts"
PCU : 36



DC 867-4 NB
44W x 21H x 15RH x 7RW
Box Quantity "87mts"
PCU : 36



CH 9115-1
44W x 23H x 13RH x 5.4RW
Box Quantity "90mts"
PCU : 31



DC 412-4 W
45W x 22H x 15RH
Box Quantity "100mts"
PCU : 27



CH 6008/3 CHER
45W x 19H x 12RH x 6.8RW
Box Quantity "72mts"
PCU : 26



CH 6008/4
48W x 19H x 12RH x 6.8RW
Box Quantity "72mts"
PCU : 26



CH 6008/6
48W x 19H x 12RH x 6.8RW
Box Quantity "72mts"
PCU : 26



CM 750 MOCCA
48W x 48H x 25RH x 12RW
Box Quantity "30mts"
PCU : 44



APM 191 MG
50W x 20H x 8RH x 7.5RW
Box Quantity "60mts"
PCU : 22



SC 507-1
50W x 24.5H x 16RH x 7.3RWR
Box Quantity "60 mts"
PCU : 51
VENEER



SC 507-2
50W x 24.5H x 16RH x 7.3RW
Box Quantity "60 mts"
PCU : 51
VENEER



CH 6010/3
50W x 20H x 14RH x 6.8RW
Box Quantity "72mts"
PCU : 23



CH 6010/1
50W x 20H x 14RH x 6.8RW
Box Quantity "72mts"
PCU : 23



CH 6010/4
50W x 20H x 14RH x 6.8RW
Box Quantity "72mts"
PCU : 23



CH 6010/6
50W x 20H x 14RH x 6.8RW
Box Quantity "72mts"
PCU : 23



CM 730 YT
49W x 20.5H x 9RH x 7RW
Box Quantity "70mts"
PCU : 28



CM 730 MT
49W x 20.5H x 9RH x 7RW
Box Quantity "70mts"
PCU : 28



APM 610 DW
52W x 19H x 10.5RH x 7RW
Box Quantity "72mts"
PCA : 23



APM 610 NB
52W x 19H x 10.5RH x 7RW
Box Quantity "72mts"
PCA : 23



CH 9102-2
53W x 37H x 17RH x 7.1RW
Box Quantity "40mts"
PCU : 41



CH 9102-3
53W x 37H x 17RH x 7.1RW
Box Quantity "40mts"
PCU : 41



APM 3609 MT
54W x 20H x 10RH x 7RW
Box Quantity "50mts"
PCA : 36



APM 121 AMBN
57W x 20H x 10RH x 7RW
Box Quantity "72mts"
PCA : 28



CM 370 FRDBR
60W x 20H x 13.5RH x 6.7RW
Box Quantity "67mts"
PCU : 34



CH 6007 / 4
61W x 20.5H x 14RH x 7RW
Box Quantity "66mts"
PCU : 34



CM 6007 / 6
61W x 20.5H x 14RH x 7RW
Box Quantity "66mts"
PCU : 34



CH 6007 / 3
61W x 20.5H x 14RH x 7RW
Box Quantity "66mts"
PCU : 34



CH 6009 / 6
61W x 20.5H x 14RH x 7RW
Box Quantity "66mts"
PCU : 34



OP 6247 ESP
62W x 47H x 19RH x 10RW
Box Quantity "40mts"
PCU : 51



APM 102 ONYX
64W x 19H x 12.5RH x 7RW
Box Quantity "67mts"
PCA : 36



APM 706 RDW
64W x 19H x 12.5RH x 7RW
Box Quantity "67mts"
PCA : 36



APM 102 WBK
64W x 19H x 12.5RH x 7RW
Box Quantity "60mts"
PCA : 46



APM 268 WG
65W x 20H x 10RH x 7RW
Box Quantity "60mts"
PCA : 35



APM 167 AW
65W x 27H x 7RH x 7RW
Box Quantity "50mts"
PCA : 41



CL 6124 BROWN
66W x 30H x 14RH x 7.5RW
Box Quantity "40mts"
PCA : 46



CL 6124 GREY
66W x 30H x 14RH x 7.5RW
Box Quantity "40mts"
PCA : 46



APM 570 ONYX
66W x 32H x 15RH x 7RW
Box Quantity "50mts"
PCA : 42



DC 413-1 TEAK
66W x 23H x 13RH x 6.8RW
Box Quantity "58mts"
PCU : 48



DC 413-2 DW
66W x 23H x 13RH x 6.8RW
Box Quantity "58mts"
PCU : 48



DC 413-3 NT
66W x 23H x 13RH x 6.8RW
Box Quantity "58mts"
PCU : 48



DC 413 - 4 W
66W x 23H x 13RH x 6.5RW
Box Quantity "58mts"
PCU : 48

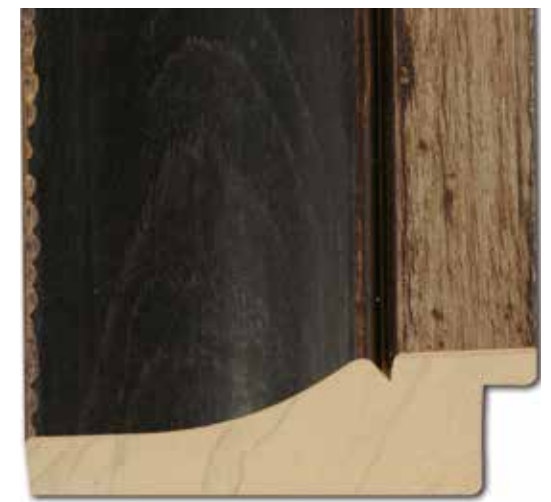

DC 1306 - 1
67W x 22H x 17RH x 7RW
Box Quantity "60mts"
PCU : 48



DC 1306 - 2
67W x 22H x 17RH x 7RW
Box Quantity "60mts"
PCU : 51



DC 1306 - 3
67W x 22H x 17RH x 7RW
Box Quantity "60mts"
PCU : 51



DC 1306 - 4
67W x 22H x 17RH x 7RW
Box Quantity "60mts"
PCU : 51



DC 1306 - 5
67W x 22H x 17RH x 7RW
Box Quantity "60mts"
PCU : 51



APM 611 RDW
68W x 19H x 12.5RH x 7RW
Box Quantity "50mts"
PCA : 31



APM 107 E ANW
68W x 33H x 10RH x 7RW
Box Quantity "42mts"
PCA : 52



APM 873 MG
70W x 20H x 9RH x 7RW
Box Quantity "40mts"
PCA : 42



APM 873 M
70W x 20H x 9RH x 7RW
Box Quantity "40mts"
PCA : 42



DC 868-4 NB
69W x 21H x 15RH x 7RW
Box Quantity "49mts"
PCA : 48



APM 580 MBN
80W x 32H x 9RH x 7RW
Box Quantity "36mts"
PCA : 47



OP 11023 ESP
110W x 23H x 17RH x 8RW
Box Quantity "35mts"
PCU : 51

EVERYDAY ORNATE



CW 308 - 2
45W x 24H x 8.5R
Box Quantity "108mts"
PCU : 29



CW 308 - 1
45W x 24H x 8.5R
Box Quantity "108mts"
PCU : 29



CS 207 - 2
70W x 28H x 9R
Box Quantity "48.8mts"
PCU : 40



CS 209 - 1
38W x 26H x 6RH
Box Quantity "76.5mts"
PCU : 11



CW 305-1
112W x 47H x 9.5RH x 7RW
Box Quantity "18mts"
PCU : 53



CW 305-2
112W x 47H x 9.5RH x 7RW
Box Quantity "18mts"
PCU : 53



CH 9100-1
20W x 24H x 13RH x .5RW
Box Quantity "152mts"
PCU : 17



CH 9100-2
20W x 24H x 13RH x 6.5RW
Box Quantity "150mts"
PCU : 17



CH 9100-3
20W x 24H x 13RH x 7RW
Box Quantity "150mts"
PCU : 17



CH 9109-1
22W x 19H x 16RH x 7RW
Box Quantity "143mts"
PCU : 17



CH 9109-2
22W x 19H x 16RH x 7RW
Box Quantity "143mts"
PCU : 17



CH 9109-3
22W x 19H x 16RH x 7RW
Box Quantity "143mts"
PCU : 17



CH 9110-1
22W x 19H x 7RH x 7RW
Box Quantity "143mts"
PCU : 19



CH 9110-2
22W x 19H x 7RH x 7RW
Box Quantity "143mts"
PCU : 19



CU 4101-1
22W x 18H x 10RH x 4.5RW
Box Quantity "140mts"
PCU : 18



CU 4101-2
22W x 18H x 10RH x 4.5RW
Box Quantity "140mts"
PCU : 18



IT-1811 ANTRAC
30W x 21H x 12RH x 6RW
Box Quantity 160mt
Price Code PCE:30



IT-1811 BIANCO
30W x 21H x 12RH x 6RW
Box Quantity 160mt
Price Code PCE:30



IT-1811 GRIGIO
30W x 21H x 12RH x 6RW
Box Quantity 160mt
Price Code PCE:30



IT-1811 NATURA
30W x 21H x 12RH x 6RW
Box Quantity 160mt
Price Code PCE:30



IT-1811 NOCE
30W x 21H x 12RH x 6RW
Box Quantity 160mt
Price Code PCE:30



CH 2072/1
30W x 22H x 8RH
Box Quantity "114mts"
PCU:19



CH 2072/2
30W x 22H x 8RH
Box Quantity "114mts"
PCU:19



CM 1211
32.5W x 17.5H x 6.2RH x 6.2RW
Box Quantity "140mts"
PCU : 19



CS 209 - 1
38W x 26H x 6RH
Box Quantity "76.5mts"
PCU : 13



CH 9101-1
39W x 24H x 10RH x 6.2RW
Box Quantity "70mts"
PCU : 23



CH 9101-2
39W x 24H x 10RH x 6.4RW
Box Quantity "70mts"
PCU : 23



• APM 371 WH
42W x 20H x 8.5RH x 7RW
Box Quantity "90mts"
PCA : 28



• APM 371 GOLD
42W x 20H x 8.5RH x 7RW
Box Quantity "90mts"
PCA : 28



CZ 2237
43W x 22H x 8RH x 7RW
Box Quantity "180mts"
PCU : 38



CH 9116-1
43W x 30H x 10RH x 8RW
Box Quantity "42mts"
PCU : 26



CZ 3541 - 2001
43W x 33H x 11RH x 8.2RW
Box Quantity "150mts"
PCU : 43



CW 308-1
45W x 24H x 8.5RH x 6.3RW
Box Quantity "108mts"
PCU : 29



CW 308-2
45W x 24H x 8.5RH x 6.3RW
Box Quantity "108mts"
PCU : 29



VC 403-1
47W x 44H x 25RH x 7RW
Box Quantity "50mts"
PCU : 44



VC 403-2
47W x 44H x 25RH x 7RW
Box Quantity "50mts"
PCU : 44

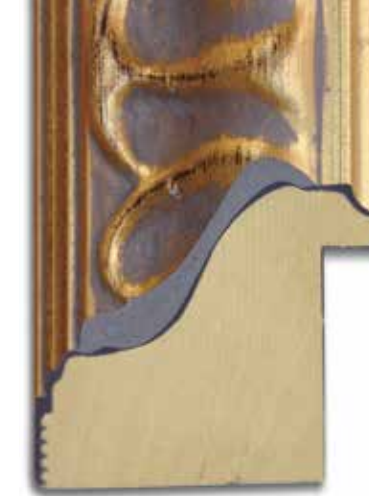

VC 403-3
47W x 44H x 25RH x 7RW
Box Quantity "50mts"
PCU : 44



VC 403-4
47W x 44H x 25RH x 7RW
Box Quantity "50mts"
PCA : 44



• APM 770-7 SILV
50W x 30H x 10RH x 7RW
Box Quantity "50mts"
PCA : 44



• APM 770-8 BL
50W x 30H x 10RH x 7RW
Box Quantity "50mts"
PCA : 44



• APM 371 BK
42W x 20H x 8.5RH x 7RW
Box Quantity "90mts"
PCA : 28



CU 4102-1
46W x 31H x 11RH x 7RW
Box Quantity "46mts"
PCU : 44



CU 4102-2
46W x 31H x 11RH x 7RW
Box Quantity "46mts"
PCU : 44



CM 650-1 MB
50W x 52H x 25RH x 7.5RW
Box Quantity "50mts"
PCU : 43



IT-1812 BIANCO
55W x 20H x 11RH x 5.5RW
Box Quantity 80mt
Price Code PCE:46



IT-1812 GRIGIO
55W x 20H x 11RH x 5.5RW
Box Quantity 80mt
Price Code PCE:46



IT-1812 NATURA
55W x 20H x 11RH x 5.5RW
Box Quantity 80mt
Price Code PCE:46



IT-1812 NOCE
55W x 20H x 11RH x 5.5RW
Box Quantity 80mt
Price Code PCE:46



CZ 2552 - 2164
53W x 27H x 8.5RH x 8.8RW
Box Quantity "78mts"
PCU : 46



CZ 2654 - 2164
56W x 27H x 8RH x 8.6RW
Box Quantity "80mts"
PCU : 44



DC 2137-1
56W x 27H x 16RH x 8RW
Box Quantity "44mts"
PCU : 44



DC 2137-2
56W x 27H x 16RH x 8RW
Box Quantity "44mts"
PCU : 44



VC 401-2 SILVER
57W x 46H x 14.5RH x 5.7RW
Box Quantity "50mts"
PCU : 55



VC 401-1 GOLD
57W x 46H x 14.5RH x 5.7RW
Box Quantity "50mts"
PCU : 55



CH 9114-1
58W x 35H x 15RH x 6.5RW
Box Quantity "34mts"
PCU : 46



CH 9114-2
58W x 35H x 15RH x 6.5RW
Box Quantity "34mts"
PCU : 46



CH 9114-3
58W x 35H x 15RH x 6.5RW
Box Quantity "39mts"
PCU : 46



CH 9114-4 (Gloss)
58W x 35H x 15RH x 6.5RW
Box Quantity "39mts"
PCU : 46



CH 9114-5 GLOSS WHITE
58W x 35H x 15RH x 6.5RW
Box Quantity "39mts"
PCU : 46



CZ 3459-3022
59W x 38H x 11RH x 8.2RW
Box Quantity "54mts"
PCU : 50



CZ 3759-3023
59W x 38H x 12RH x 8.2RW
Box Quantity "54mts"
PCU : 51



CZ 3759-2001
59W x 38H x 12RH x 8.2RW
Box Quantity "54mts"
PCU : 51



CZ 4164 - 2114
63W x 44H x 9RH x 10.5RW
Box Quantity "54mts"
PCU : 51



CZ 3164 - 3111
66W x 36H x 9.5RH x 8RW
Box Quantity "54mts"
PCU : 50

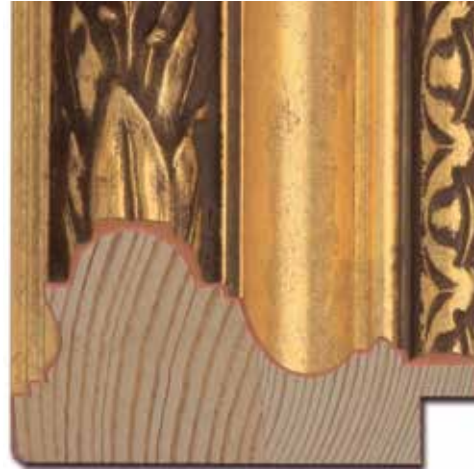

CZ 3164 - 2164
66W x 36H x 9.5RH x 8RW
Box Quantity "54mts"
PCU : 50



CS 207 - 2
70W x 28H x 9RH x 7RW
Box Quantity "48.8mts"
PCU : 42



VC 402-2 WH
62W x 43H x 28RH x 7.6RW
Box Quantity "45mts"
PCU : 50



VC 402-1 BK
62W x 43H x 28RH x 7.6RW
Box Quantity "45mts"
PCU : 50



VC 402-3 WV
62W x 43H x 28RH x 7.6RW
Box Quantity "45mts"
PCU : 50



VC 402-4
62W x 43H x 28RH x 7.6RW
Box Quantity "45mts"
PCU : 50



DC 2229-2
69W x22H x 10RH x 6.8RW
Box Quantity "40mts"
PCU : 48



DC 2229-1
69W x22H x 10RH x 6.8RW
Box Quantity "40mts"
PCU : 48



CH 2089/1
73W x 30.5H x 8RH
Box Quantity "40mts"
PCU : 48

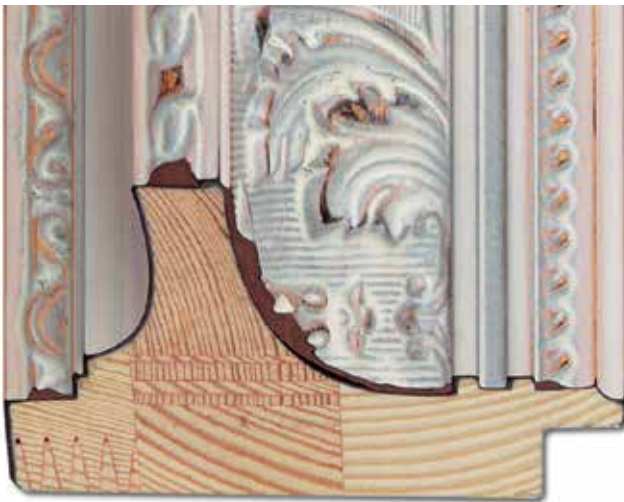

• APM 4279 WH
79W x45H x 10RH x 10.5RW
Box Quantity"35mts"
PCA : 55



CZ 5075 - 2115
79W x 50H x 11RH x 10.5RW
Box Quantity "30mts"
PCU : 61



CZ 4279-5112
79W x45H x 10RH x 10.5RW
Box Quantity"36mts"
PCU : 55

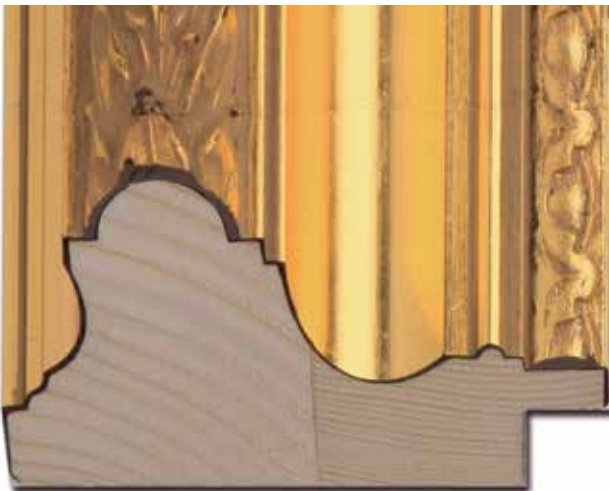

CZ 4078-2114
79W x44H x 10RH x 10RW
Box Quantity"30mts"
PCU : 55



CZ 4078-2164
79W x44H x 10RH x 10RW
Box Quantity"36mts"
PCU : 55



ACM 508 STERLI
80W x 22H x 12RH x 7RW
Box Quantity 30mt
Price Code ACM V



ACM 508 LICORI
80W x 22H x 12RH x 7RW
Box Quantity 30mt
Price Code ACM V



ACM 690 STERLI
80W x 22H x 12RH x 7RW
Box Quantity 30mt
Price Code ACM V



ACM 690 LICORI
80W x 22H x 12RH x 7RW
Box Quantity 30mt
Price Code ACM V



VC 400-1 BK
85W x 45H x 15RH x 8.2RW
Box Quantity "25mts"
PCU : 52



VC 400-2 WH
85W x 45H x 15RH x 8.2RW
Box Quantity "25mts"
PCU : 52



VC 400-3 GOLD
85W x 45H x 15RH x 8.2RW
Box Quantity "25mts"
PCU : 52



CW 302 - 1 GOLD
81W x 52H x 12RH x 9.5RW
Box Quantity "27mts"
PCU : 46



CZ 3587-4001
89W x 40H x 10RH x 9.5RW
Box Quantity "36mts"
PCU : 59



VC 400-4 SIL
85W x 45H x 15RH x 8.2RW
Box Quantity "25mts"
PCU : 52



CZ 5591 - 2111
93W x 58H x 39RH x 10.5RW
Box Quantity "24mts"
PCU : 63



CW 305 WH
112W x 47H x 9.5RH x 7RW
Box Quantity "18mts"
PCU : 53



CW 303-1 GOLD
114W x 39H x 18RH x 9.5RW
Box Quantity "24mts"
PCU : 50



CW 301 - 1
105W x 49H x 17RH x RW 8
Box Quantity "21.6mts"
Price Code PCU 52



CW 303-2 SILVER
114W x 39H x 18RH x 9RW
Box Quantity "24mts"
PCU : 50



CW 305 BKSI
112W x 47H x 9.5RH x 7RW
Box Quantity "45mts"
PCU : 53



CW 305-2
112W x 47H x 9.5RH x 7RW
Box Quantity "18mts"
PCU : 53



CW 305-1
112W x 47H x 9.5RH x 7RW
Box Quantity "18mts"
PCU : 53



• APM 2 BLACK
34W x 55H x 45RH x 24RW
Box Quantity "50mts"
PCA : 50



• APM 2 CARBON
34W x 55H x 45RH x 24RW
Box Quantity "50mts"
PCA : 50



• APM 2 CASHEW
34W x 55H x 45RH x 24RW
Box Quantity "50mts"
PCA : 50



• APM 2 CHALK
34W x 55H x 45RH x 24RW
Box Quantity "50mts"
PCA : 50



• APM 2 CHARCOAL
34W x 55H x 45RH x 24RW
Box Quantity "50mts"
PCA : 50



• APM 2 COYOTE
34W x 55H x 45RH x 24RW
Box Quantity "50mts"
PCA : 50



• APM 2 WENGE
34W x 55H x 45RH x 24RW
Box Quantity "50mts"
PCA : 50



• APM 2 ZEBRANO
34W x 55H x 45RH x 24RW
Box Quantity "50mts"
PCA : 50



• APM 23 BK
34W x 55H x 45RH x 24RW
Box Quantity "50mts"
PCA : 50



• RAW 2 OAK
34W x 55H
Box Quantity "35mts"
PCA : 50



• RAW 2 OAK BRONZE
34W x 55H
Box Quantity "35mts"
PCA : 51



• RAW 2 OAK BK
34W x 55H
Box Quantity "35mts"
PCA : 51



• RAW 2 OAK WH
34W x 55H
Box Quantity "35mts"
PCA : 51



• CM 290 WHITE
35.5W x 55.5H x 45RH x 22.5RW
Box Quantity "42mts"
PCU : 45



CM 290 BK
35.5W x 55.5H
Box Quantity "42mts"
PCU : 45



CM 290 RAWM
35.5W x 55.5H
Box Quantity "42mts"
PCU : 48



CM 280-1
55W x 36H
Box Quantity "60.2mts"
PCU : 46
timber



CM 280-2
55W x 36H
Box Quantity "60.2mts"
PCU : 46
timber



CU 4100-1
38W x 56H x 44RH x 30RW
Box Quantity "44mts"
PCU : 47



CU 4100-2
38W x 56H x 44RH x 30RW
Box Quantity "44mts"
PCU : 47



CU 4100-6
38W x 56H x 44RH x 30RW
Box Quantity "44mts"
PCU : 47



CU 4100-3
38W x 56H x 44RH x 30RW
Box Quantity "44mts"
PCU : 47



CU 4100-4
38W x 56H x 44RH x 30RW
Box Quantity "44mts"
PCU : 47



CU 4100-5
38W x 56H x 44RH x 30RW
Box Quantity "44mts"
PCU : 47



CM 520 WH
20W x 6H
Box Quantity "200mts"
PCU : 8
timber



• APM 280 BK
32W x 34H
Box Quantity "48mts"
PCA : 25
timber



• APM 280 WH
32W x 34H
Box Quantity "48mts"
PCA : 25
timber



CM 220WH
24W x 18H x 7R
Box Quantity "130mts"
PCU : 10
timber



CM 1" LINEN
26W x 15H x 7RH
Box Quantity "244mts"
PCU : 14
timber



CM 1" 1/4 LINEN
32W x 18H x 8RH
Box Quantity "190mts"
PCU : 19
timber



APM 270 OBURG
31W x 45H x 35RH x 22RW
Box Quantity "55mts"
PCA : 42



CM 270 MOCCA
31W x 45H x 35RH x 22RW
Box Quantity "55mts"
PCU : 42



CM 270 MB
31W x 45H x 35RH x 22RW
Box Quantity "80mts"
PCU : 42



CM 270 WHITE
31W x 45H x 35RH x 22RW
Box Quantity "80mts"
PCU : 42



CM 270 RAW
31W x 45H x 35RH x 22RW
Box Quantity "80mts"
PCU : 42



• APM 270 OBK
31W x 45H x 35RH x 22RW
Box Quantity "55mts"
PCA : 42



• APM 270 0MOCCA
31W x 45H x 35RH x 22RW
Box Quantity "55mts"
PCA : 42



• APM 270 OCHAR
31W x 45H x 35RH x 22RW
Box Quantity "55mts"
PCA : 42



• APM 270 OWH
31W x 45H x 35RH x 22RW
Box Quantity "55mts"
PCA : 42



OP 6029 RAW
29W x 60H x 45RH x 22RW
Box Quantity "80mts"
PCU : 46



OP 6028 RAW
28W x 60H x 35RH x 21RW
Box Quantity "80mts"
PCU : 46



OP 6028 BK
28W x 60H x 35RH x 21RW
Box Quantity "80mts"
PCU : 46



OP 6029 BK
29W x 60H x 45RH x 22RW
Box Quantity "80mts"
PCU : 46



OP 6028 ESP
28W x 60H x 35RH x 21RW
Box Quantity "80mts"
PCU : 46



EMA 1
10.5W x 5H
Box Quantity "200mts"
PCU : 7



OP 6028 WH
28W x 60H x 35RH x 21RW
Box Quantity "80mts"
PCU : 46



OP 6029 WH
29W x 60H x 45RH x 22RW
Box Quantity "80mts"
PCU : 46



OP 6029 ESP
29W x 60H x 45RH x 22RW
Box Quantity "80mts"
PCU : 46



ACM 34 IVNG
33W x 16H x 8RH x 7RW
Box Quantity 126mt
Price Code ACM G



ACM 34 IVS
33W x 16H x 8RH x 7RW
Box Quantity 126mt
Price Code ACM G

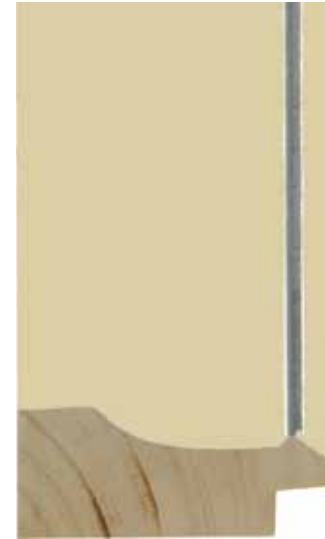

ACM 44 IVS
44W x 19H x 7RH x 7RW
Box Quantity 90mt
Price Code ACM H



CM 221 WH
42 W x 20H x 9RH x 6.2RW
Box Quantity "100mts"
PCU : 21



ACM 44 IVGWL
44W x 19H x 7RH x 7RW
Box Quantity 90mt
Price Code ACM H



APM 518 CRG
54W x 20H x 7RH x 7RW
Box Quantity "41mts"
PCA : 28

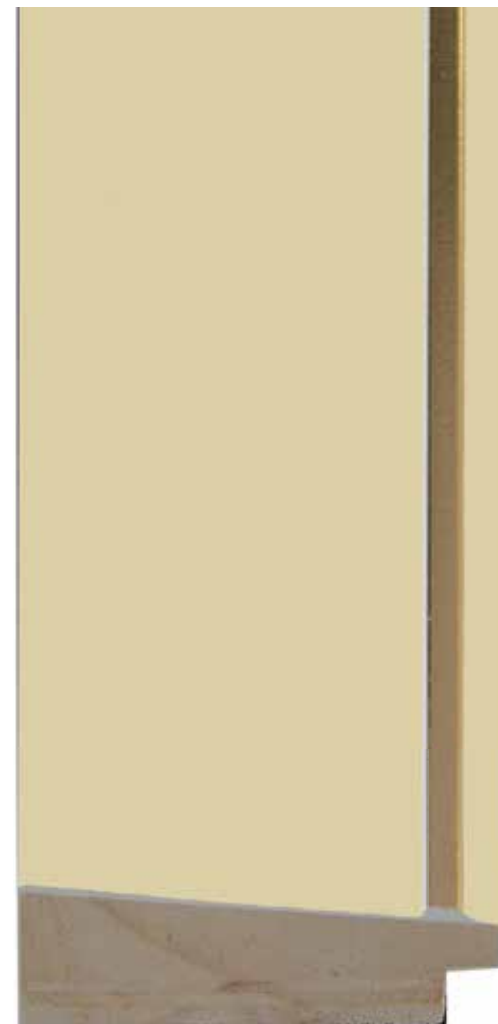

ACM 60 IV
66W x 19H x 7RH x 7.5RW
Box Quantity 54mt
Price Code ACM L



• APM 270 OCLEAR
31W x 44H x 35RH x 22.5RW
Box Quantity "60mts"
PCA : 47



APM T804 EMULBERRY
17W x 10H x 5RH x 4RW
Box Quantity "250mts"
PCA : 13



APM T804 RGY
17W x 10H x 5RH x 4RW
Box Quantity "250mts"
PCA : 13



APM T804 RBK
17W x 10H x 5RH x 4RW
Box Quantity "250mts"
PCA : 13



APM T804 EOATMEAL
17W x 10H x 5RH x 4RW
Box Quantity "250mts"
PCA : 13



APM T804 RDW
17W x 10H x 5RH x 4RW
Box Quantity "250mts"
PCA : 13



APM T804 ESNOWGUM
17W x 10H x 5RH x 4RW
Box Quantity "250mts"
PCA : 13



APM T804 ECASHEW
17W x 10H x 5RH x 4RW
Box Quantity "250mts"
PCA : 13



APM T804 ECAMEL
17W x 10H x 5RH x 4RW
Box Quantity "250mts"
PCA : 13



CHF 2
14W x 8H
Box Quantity "500mts"
PCU : 12



CHF 3
15W x 5H
Box Quantity "500mts"
PCU : 10



CHF 4
14W x 8H
Box Quantity "500mts"
PCU : 12



CHF 2094-4
11W x 5H
Box Quantity "450mts"
PCU : 7



CHF 2095 / 1
14W x 8H
Box Quantity "450mts"
PCU : 12



CHF 2095 / 2
14W x 8H
Box Quantity "450mts"
PCU : 12



CHF 2096 / 1
14W x 7.5H
Box Quantity "500mts"
PCU : 12



CHF 2097 / 3
14W x 7H
Box Quantity "450mts"
PCU : 7



CHF 2098 / 1
10.5W x 5H
Box Quantity "450mts"
PCU : 10



CHF 2099 / 1
10.5W x 6.5H
Box Quantity "450mts"
PCU : 8



CH 466 SG 107
16W x 5H
Box Quantity "752mts"
PCU : 1



CH 466 5530
16W x 5H
Box Quantity "752mts"
PCU : 1



CH 466 21049
16W x 5H
Box Quantity "752mts"
PCU : 1



CPF 1001 - 1
15W x 6H
Box Quantity "400mts"
PCU : 1



CPF 1001 - 2
15W x 6H
Box Quantity "400mts"
PCU : 1



CPF 1001 - 3
15W x 6H
Box Quantity "400mts"
PCU : 1



CPF 1001 - 5
15W x 6H
Box Quantity "400mts"
PCU : 1



CPF 1001 - 6
15W x 6H
Box Quantity "400mts"
PCU : 1



CPF 1001-7
15W x 8H
Box Quantity "400mts"
PCU : 1



CPF 1001-8
15W x 8H
Box Quantity "400mts"
PCU : 1



CPF 1001-10
15W x 8H
Box Quantity "400mts"
PCU : 1



CPF 1002-1
12.5W x 6.5H
Box Quantity "400mts"
PCU : 1



CPF 1002-2
12.5W x 6.5H
Box Quantity "400mts"
PCU : 1



CPF 1002-3
12.5W x 6.5H
Box Quantity "400mts"
PCU : 1



CPF 1002-4
12.5W x 6.5H
Box Quantity "400mts"
PCU : 1



CPF 1002-5
12.5W x 6.5H
Box Quantity "400mts"
PCU : 1



CPF 1002-8
12.5W x 6.5H
Box Quantity "400mts"
PCU : 1



CPF 1003-1
15W x 6H
Box Quantity "400mts"
PCU : 1



CPF 1003-2
15W x 6H
Box Quantity "400mts"
PCU : 1



CPF 1003-3
15W x 6H
Box Quantity "400mts"
PCU : 1



CP308-1
12W x 7H
Box Quantity "400mts"
PCU : 1



CP308-2
12W x 7H
Box Quantity "400mts"
PCU : 1



CPF 1004-1
17.5W x 8H
Box Quantity "400mts"
PCU : 1



CPF 1004-2
17.5W x 8H
Box Quantity "400mts"
PCU : 1



CPF 1005-1
16W x 5H
Box Quantity "400mts"
PCU : 1



CPF 1005-2
16W x 5H
Box Quantity "400mts"
PCU : 1



CPF 1006-1
16W x 7H
Box Quantity "400mts"
PCU : 1



CPF 1006-2
16W x 7H
Box Quantity "400mts"
PCU : 1



CPF 1006-3
16W x 7H
Box Quantity "400mts"
PCU : 1



CPF 1007-1
17.5W x 8H
Box Quantity "400mts"
PCU : 1



CPF 1007-2
17.5W x 8H
Box Quantity "400mts"
PCU : 1



CPF 1007-3
17.5W x 8H
Box Quantity "400mts"
PCU : 1



CPF 1008-1
17.5W x 8H
Box Quantity "400mts"
PCU : 1



CPF 1008-2
17.5W x 8H
Box Quantity "400mts"
PCU : 1



EMA 2
10.5W x 5H
Box Quantity "200mts"
PCU : 7

EVERYDAY SYNTHETICS



CP 300 - 1BK
20W x 31H x 24.5RH x 6.1RW
Box Quantity "200mts"
PCU : 5



CP 300 - 5
20W x 31H x 24.5RH x 6.1RW
Box Quantity "200mts"
PCU : 5



CH 100 - 1
32W x 15H x 8RH x 7.5RW
Box Quantity "110mts"
PCU : 3



CH 100 - 2
32W x 15H x 8RH x 7.5RW
Box Quantity "110mts"
PCU : 3



CH 100 - 3
32W x 15H x 8RH x 7.5RW
Box Quantity "110mts"
PCU : 3



CH 100 - 4
32W x 15H x 8RH x 7.5RW
Box Quantity "110mts"
PCU : 3



CH 101 - 1
42W x 18H x 13RH x 8RW
Box Quantity "90mts"
PCU : 8



CH 101 - 2
42W x 18H x 13RH x 8RW
Box Quantity "90mts"
PCU : 8



CH 101 - 3
42W x 18H x 13RH x 8RW
Box Quantity "90mts"
PCU : 8



DC BLACK/GOLD
42W x 19.5H x 8RH x 7RW
Box Quantity "101mts"
PCU : 6



DC BLACK/SILVE
42W x 19.5H x 8RH x 7RW
Box Quantity "101mts"
PCU : 6



DC MAHO
42W x 19.5H x 8RH x 7RW
Box Quantity "101mts"
PCU : 6



DC WALNUT
42W x 19.5H x 8RH x 7RW
Box Quantity "101mts"
PCU : 6



CH 4235-1
44W x 33H x 26RH x 7RW
Box Quantity "58mts"
PCU : 18



CH 4235-2 WH
44W x 33H x 26RH x 7RW
Box Quantity "58mts"
PCU : 18



CPS 801-1
19W x 31H x 23RH
Box Quantity "162mts"
PCU : 4



CH 32 - 4
20.5W x 14H x 9RH x 5RW
Box Quantity "278.4mts"
PCU : 1



CP 300 - 1BK
20W x 31H x 24.5RH x 6.1RW
Box Quantity "200mts"
PCU : 5



CP 300 - 4 PUREW
20W x 31H x 24.5RH x 6.1RW
Box Quantity "200mts"
PCU : 5



CP 300 - 5
20W x 31H x 24.5RH x 6.1RW
Box Quantity "200mts"
PCU : 5



CH 2366 - 1
25W x 16H x 9RH
Box Quantity "102.4mts"
PCU : 5



386 SG
25W x 12H x 6.5RH
Box Quantity "200mts"
PCU : 3



CH 9007 - 1
26.5W x 15.5H x 6.5RH
Box Quantity "185.6mts"
PCU : 4



386 - BLACK
25W x 12H x 6.5RH x 4.7RW
Box Quantity "200mts"
PCU : 3



CH 100-7
30.5W x 15.5H x 9RH x 7RW
Box Quantity "162mts"
PCU : 3



286 - BLACK
31W x 14H x 8RH
Box Quantity "185mts"
PCU : 5



TKY-BLK
31.5W x 21.5H x 9RH
Box Quantity "180mts"
PCU : 6



CH 1080 BLACK
32W x 18.5H x 10RH
Box Quantity "164mts"
PCU : 5



SCRATCH
RESISTANT

CH 100 - 1
32W x 15H x 8RH x 7.5RW
Box Quantity "110mts"
PCU : 3



SCRATCH
RESISTANT

CH 100 - 2
32W x 15H x 8RH x 7.5RW
Box Quantity "110mts"
PCU : 3



SCRATCH
RESISTANT

CH 100 - 3
32W x 15H x 8RH x 7.5RW
Box Quantity "110mts"
PCU : 3



SCRATCH
RESISTANT

CH 100 - 4
32W x 15H x 8RH x 7.5RW
Box Quantity "110mts"
PCU : 3



CH 100 - 5
32W x 15H x 8RH x 7.5RW
Box Quantity "162mts"
PCU : 3



CH 100 - 6
32W x 15H x 8RH x 7.5RW
Box Quantity "110mts"
PCU : 3



CH 105 - 1
32W x 31H x 15RH x 7.5RW
Box Quantity "81mts"
PCU : 12



CH 105 - 2 BLK
32W x 31H x 15RH x 7.5RW
Box Quantity "81mts"
PCU : 12



CH 3542-2 BKS
35W x 45H x 27RH
Box Quantity "50mts"
PCU : 5



CH 3542 BK
35W x 45H x 27RH
Box Quantity "50mts"
PCU : 5



CH 3542-3 WH
35W x 45H x 27RH
Box Quantity "50mts"
PCU : 5



CG 201-2
35W x 24H x 10RH x 6.8RW
Box Quantity "101.5mts"
PCU : 15



CG 201-3
35W x 24H x 10RH x 6.8RW
Box Quantity "101.5mts"
PCU : 15



CG 201-4
35W x 24H x 10RH x 6.8RW
Box Quantity "101.5mts"
PCU : 15

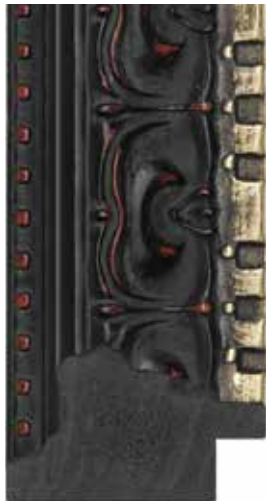

CG 201-5
35W x 24H x 10RH x 6.8RW
Box Quantity "101.5mts"
PCU : 15



SCRATCH
RESISTANT

CH 102 - 1
36W x 15H x 9RH x 6.8RW
Box Quantity "120mts"
PCU : 5



SCRATCH
RESISTANT

CH 102 - 2
36W x 15H x 9RH x 6.8RW
Box Quantity "120mts"
PCU : 5



SCRATCH
RESISTANT

CH 102 - 3
36W x 15H x 9RH x 6.8RW
Box Quantity "120mts"
PCU : 5



CH 3312 - 2
38W x 25H x 13RH x 7RW
Box Quantity "99mts"
PCU : 11



CH 608 - 14 WALNUT
39W x 20H x 9.5RH x 6.2RW
Box Quantity "85.5mts"
PCU : 7



CH 608 - 12 DARK MAHOGA NY
39W x 20H x 9.5RH x 6.2RW
Box Quantity "85.5mts"
PCU : 7



CH 9000
39Wx17Hx6.5R
Box Quantity "125.4mts"
PCU : 6



SF 608 SILVER
40W x 19H x 10RH
Box Quantity "85.5mts"
PCU : 6



DP 100 S SML
40.5W x 19H x 9.5RH x 7RW
Box Quantity "110mts"
PCU : 9



CH 2220 - S
40.5W x 15.5H x 9.5RH x 6.7RW
Box Quantity "116mts"
PCU : 7



CH 2146 BLACK
40W x 18.5H x 10RH x 6.7RW
Box Quantity "116mts"
PCU : 6



CH BLACK
40W x 14.5H x 9.5RH x 7.8RW
Box Quantity "108.3mts"
PCU : 6



CH BROWN
40W x 14.5H x 9.5RH x 7.8RW
Box Quantity "108.3mts"
PCU : 6



DRM BLUE
40W x 18H x 8RH x 6.6RW
Box Quantity "99.7mts"
PCU : 6



DRM WALNUT
40W x 18H x 8RH x 6.6RW
Box Quantit "99.7mts"
PCU : 6



CH 2146 WHITE
40W x 18.5H x 10RH x 6.7RW
Box Quantity "116mts"
PCU : 6



CG 202 - 1
40W x 27H x 12RH x 6.5RW
Box Quantity "87mts"
PCU : 17



CG 202 - 2
40W x 27H x 12RH x 6.5RW
Box Quantity "87mts"
PCU : 17



CG 202 - 3
40W x 27H x 12RH x 6.5RW
Box Quantity "87mts"
PCU : 17



CG 202 - 4
40W x 27H x 12RH x 6.5RW
Box Quantity "87mts"
PCU : 17



CG 202 - 5
40W x 27H x 12RH x 6.5RW
Box Quantity "87mts"
PCU : 17



CG 202 - 6
40W x 27H x 12RH x 6.5RW
Box Quantity "87mts"
PCU : 17



DC BLACK/GOLD
42W x 19.5H x 8RH x 7RW
Box Quantity "101mts"
PCU : 6



DC BLACK/SILVE
42W x 19.5H x 8RH x 7RW
Box Quantity "101mts"
PCU : 6



DC MAHO
42W x 19.5H x 8RH x 7RW
Box Quantity "101mts"
PCU : 6



DC WALNUT
42W x 19.5H x 8RH x 7RW
Box Quantity "101mts"
PCU : 6



CH 245 AC
42W x 19H x 11.5RH x 7RW
Box Quantity "90mts"
PCU : 6



SCRATCH
RESISTANT

CH 101 - 1 BLACK
42W x 18H x 13RH x 9RW
Box Quantity "90mts"
PCU : 8



SCRATCH
RESISTANT

CH 101 - 2
42W x 18H x 13RH x 8RW
Box Quantity "90mts"
PCU : 8



CH 101 - 3
42W x 18H x 13RH x 8RW
Box Quantity "90mts"
PCU : 8



CH 103 - 4 MCS
43W x 20H x 13RH x 8RW
Box Quantity "90mts"
PCU : 8



CH 103 - 6 BRLS
43W x 20H x 13RH x 8RW
Box Quantity "90mts"
PCU : 8



CH 103 BKS
43W x 20H x 13RH x 8RW
Box Quantity "87mts"
PCU : 8



CH 2676-3
44W x 24H x 10RH
Box Quantity "80mts"
PCU : 8



CH 2323-4
44.5W x 28H x 12.5RH
Box Quantity "68.4mts"
PCU : 8



CH 4235-1
44W x 33H x 26RH x 7RW
Box Quantity "58mts"
PCU : 18



CH 4235-2 WH
44W x 33H x 26RH x 7RW
Box Quantity "58mts"
PCU : 18



CH 818 BLK
44W x 36H x 14RH x 10RW
Box Quantity "58mts"
PCU : 17



CH 818 BP
44W x 36H x 14RH x 10RW
Box Quantity "58mts"
PCU : 17



CH 818 WH
44W x 36H x 14RH x 10RW
Box Quantity "58mts"
PCU : 17



CH 445 - 1
43W x 21.5H x 12RH x 7.3RW
Box Quantity "79mts"
PCU : 9



CH 2456 - 5
48W x 50H x 19RH
Box Quantity "72mts"
PCU : 16



CH 2456 - WH
48W x 50H x 19RH x 7RW
Box Quantity "72mts"
PCU : 16



CH 4900 SILVER
48.5W x 16H x 9RH x 6.4RW
Box Quantity "116mts"
PCU : 7

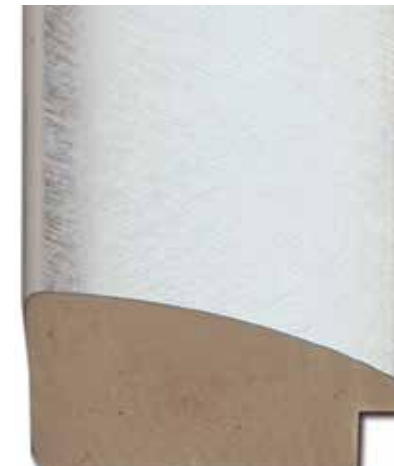

CH 97 S
49W x 25.5H x 9RH x 5.8RW
Box Quantity "69.6mts"
PCU : 13



CH 2587(SMALL) GOLD
50W x 33H x 10RH
Box Quantity "48.4mts"
PCU : 15



SF 647-176
50W x 31H x 18RH
Box Quantity "50mts"
PCU : 15



CH 6100 G
51Wx20Hx11RH
Box Quantity "89.9mts"
PCU : 13



CH 4001-176
52.5Wx17Hx8RH
Box Quantity "102.6mts"
PCU : 10



CH 97 G
49W x 25.5H x 9RH x 5.8RW
Box Quantity "69.6mts"
PCU : 13



CH 103 BKG
43W x 20H x 13RH x 8RW
Box Quantity "87mts"
PCU : 8



CH 104 - 4
50W x 19H x 11RH x 8RW
Box Quantity "60mts"
PCU : 13



CH 2587 SML-S
50W x 33H x 10RH x 8.8RW
Box Quantity "48.4mts"
PCU : 15



DC BLK/GOLD LG
50W x 20H x 8RH x 7.2RW
Box Quantity "81mts"
PCU : 10



DC BLK/SIL LG
50W x 20H x 8RH x 7.2RW
Box Quantity "81mts"
PCU : 10



CH 7 DB
42W x 22H x 10RH x 7.2RW
Box Quantity "91.2mts"
PCU : 6



DC MAHOG LG
50W x 20H x 8RH x 7.2RW
Box Quantity "81mts"
PCU : 10



DC WALNUT LG
50W x 20H x 8RH x 7.2RW
Box Quantity "81mts"
PCU : 10



CH 265 BS
50W x 22H x 11RH x 9RW
Box Quantity "191mts"
PCU : 10



CH 265 - A254
50W x 22H x 11RH x 9RW
Box Quantity "191mts"
PCU : 10



CP 5720 SILVER
56W x 20H x 13.5RH x 7.5RW
Box Quantity "69mts"
PCU : 13



CH 5445 - 1 BK
56W x 45H x 26RH x 10RW
Box Quantity "35mts"
PCU : 41



CH 5445 - 2 SILV
56W x 45H x 26RH x 10RW
Box Quantity "35mts"
PCU : 41



CH 5445 - 3 WHITE
56W x 45H x 26RH x 10RW
Box Quantity "35mts"
PCU : 41



CH 97 SILVER (L)
58Wx34.5Hx11RH
Box Quantity "43.5mts"
PCU : 14



CH 97 GOLD (L)
58Wx34.5Hx11RH
Box Quantity "43.5mts"
PCU : 14



SF 665-176
59W x 26H x 11RH x 7.6RW
Box Quantity "69.6mts"
PCU : 14



CU3 - NEG
59W x 19H x 11.5RH x 6.5RW
Box Quantity "28.5mts"
PCU : 11



CU3 - NES
59W x 19H x 11.5RH x 6.5RW
Box Quantity "28.5mts"
PCU : 11



CH 110 S-C
59W x 19H x 7RH x 7.5RW
Box Quantity "81.2mts"
PCU : 15



CH 2405/3 GOLD
64W x 32.5H x 17.5RH
Box Quantity "39.9mts"
PCU : 19



SF 646-174 SILVER
65W x 31H x 16RH
Box Quantity "34.2mts"
PCU : 20



CH 2335 (SM)SILVER
68W x 34H x 11.5RH
Box Quantity "33.5mts"
PCU: 25

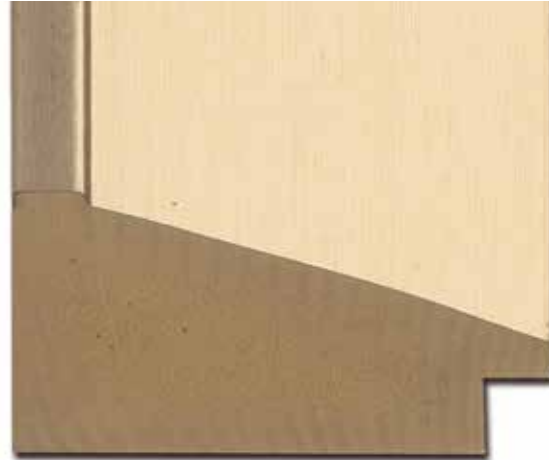

CH 2587 (MEDIUM) GOLD
69W x 36H x 10RH
Box Quantity "37.05mts"
PCU: 25



CH 1001 G
69W x 22H x 14.5RH
Box Quantity "45.6mts"
PCU: 21



CH 1001 S
69W x 22H x 14.5RH
Box Quantity "45.6mts"
PCU: 21

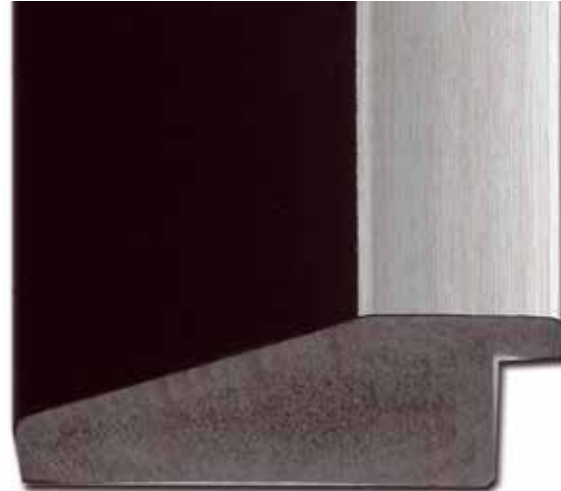

CH 267-S126
65W x 25H x 19RH x 8RW
Box Quantity "57mts"
PCU : 19



CH 2587 MED-S
69W x 36H x 10RH
Box Quantity "37.05mts"
PCU : 25

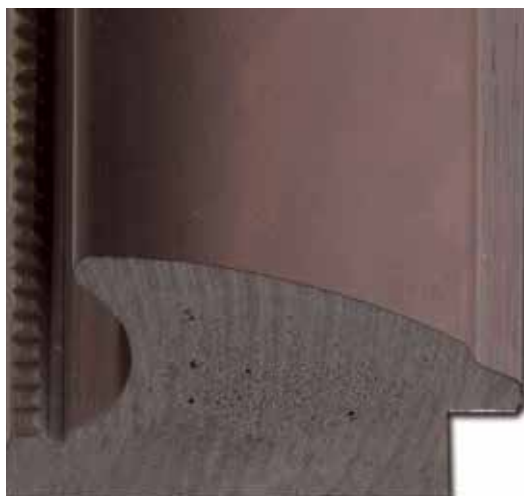

CH 2628 - 3
69W x 33H x 13RH
Box Quantity "43mts"
PCU : 25



CH 2628 - 1
69W x 33H x 13RH x 7RW
Box Quantity "43mts"
PCU : 25



CH 2628 - 2
69W x 33H x 13RH x 7RW
Box Quantity "43mts"
PCU : 25



595 C GOLD
74W x 25H x 14.5RH
Box Quantity "34mts"
PCU: 19



CH 480 BG
74.5W x 26H x 15RH
Box Quantity "43.5mts"
PCU: 19



CH 110 GOLD
80W x 28H x 8.5RH
Box Quantity "37.7mts"
PCU : 27



CP 306 - 1 SILVER
80W x 29H x 10RH
Box Quantity "35mts"
PCU : 22



CH 2422 SMALL SILVER
80W x 24.5H x 12RH
Box Quantity "43.2mts"
PCU : 27

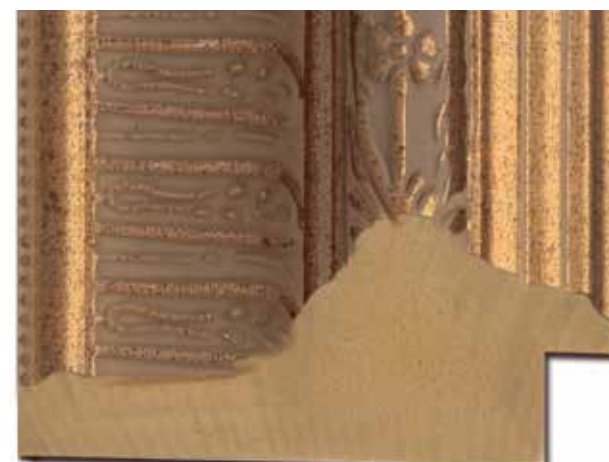

CH 5001-6
82W x 38H x 18.5RH
Box Quantity "28.5mts"
PCU: 37



CH 2291-7
85W x 41.5H x 12.5RH
Box Quantity "28.5mts"
PCU : 28



FH3-NES
80W x 32H x 12.5RH x 6.8RW
Box Quantity "28.5mts"
PCU : 20



FH3 N-NG
80W x 32H x 12.5RH x 6.8RW
Box Quantity "28.5mts"
PCU : 20

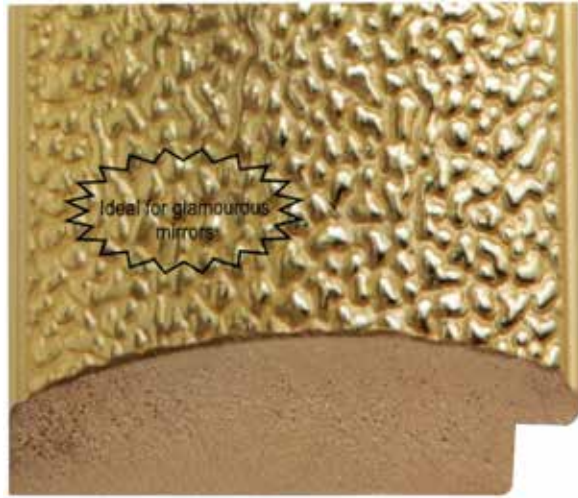

CP 310 - 1
77W x 26H x 10RH x 7.7RW
Box Quantity "52mts"
PCU : 29



CH 2587 (LARGE) SILVER
90W x 35H x 10RH
Box Quantity "28.5mts"
PCU : 31



CP 307-1 BG
90W x 43H x 18RH
Box Quantity "27mts"
PCU : 41

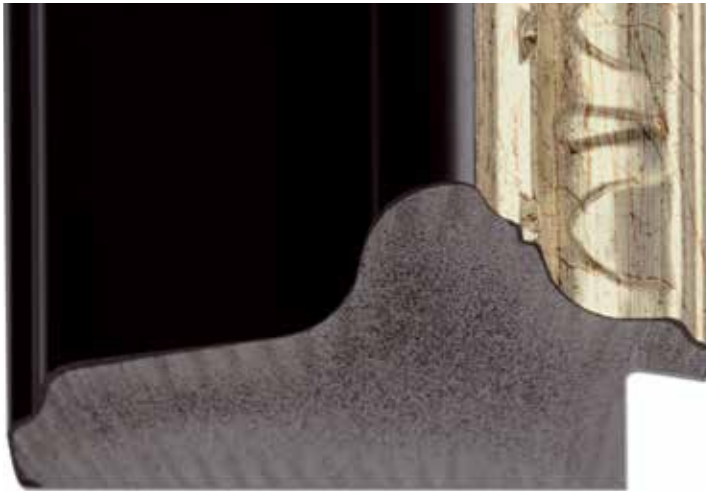

CP 307-2 BS
90W x 43H x 18RH
Box Quantity "27mts"
PCU : 41



CH 366 - 3 SILVER WITH BLACK
84W x 57H x 11RH
Box Quantity "23mts"
PCU : 37



CH 3372 - 2
85W x 28.5H x 9.5RH
Box Quantity "40mts"
PCU : 29



CH 2669-3
88.5W x 35.5H x 9.5RH
Box Quantity "30mts"
PCU : 41



DP 100 SILVER
89W x 31H x 15RH
Box Quantity "29mts"
PCU : 27



CH 2587(LARGE) GOLD
90W x 35H x 10RH
Box Quantity "28.5mts"
PCU : 31



RAW 63 VERTICA
20W x 63H
Box Quantity "60mts"
PCA : 15



RAW 30 X 30 STRET
30W x 30H
Box Quantity "60mts"
PCU : 9



RAW 32 X 38
32W x 38H
Box Quantity "50mts"
PCU : 10



RAW REV 3238
32W X 38H
Box Quantity "52mts"
PCU : 12



RAW 40MM STRET
40W x 18H
Box Quantity "90mts"
PCU : 9



RAW 40 X 40 STRET
40W x 40H
Box Quantity "50mts"
PCU : 20



RAW 30MM STRET
30W x 18H
Box Quantity "120mts"
PCU : 8



RAW 63MM STRET
63W x 18.5H
Box Quantity "60mts"
PCU : 11



RAW 67 X 33
67W x 33H
Box Quantity "40mts"
PCU : 28



RAW 67 X 29 STRETCHER
67W x 29H
Box Quantity "45mts"
PCU : 20



RAW 4 str bar
63W x 25H
Box Quantity "55mts"
PCU:18



LAM 63MM
63W x 21H
Box Quantity "57mts"
PCU : 17



LAM 67X33
67W x 34H
Box Quantity "29mts"
PCU : 30



RAW 75
75W x 40H
Box Quantity "40mts"
PCU : 30



PF 5 MATT BLACK
9.5W x 20H x 15RH x 5.2RW
Box Quantity "10bars"
AL : 4



PF 3 MATT BLACK
12.5W x 11.8H x 7.3RH x 11RW
Box Quantity "10bars"
AL : 4

Ideal for frameless
pictures or mirrors

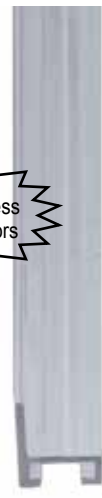

PF 3 MATT SILVER
12.5W x 11.8H x 7.3RH x 11RW
Box Quantity "10bars"
AL : 4



PF 4 MATT BLACK
12.5W x 15H x 10.5RH x 11RW
Box Quantity "10bars"
AL : 4

Ideal for frameless
pictures or mirrors



PF 4 MATT SILVER
12.5W x 15H x 10.5RH x 11RW
Box Quantity "10bars"
AL : 4



PF 6 MATT BLACK
12.5W x 20.5H x 10RH x 7RW
Box Quantity "10bars"
AL : 2



PF 6 MATT GOLD
12.5W x 20.5H x 10RH x 7RW
Box Quantity "10bars"
AL : 5



PF 6 MATT SILVER
12.5W x 20.5H x 10RH x 7RW
Box Quantity "10bars"
AL : 5



PF 6 SHINY BLACK
12.5W x 20.5H x 10RH x 7RW
Box Quantity "10bars"
AL : 9



PF 6 WHITE
12.5W x 20.5H x 10RH x 7RW
Box Quantity "10bars"
AL : 5



PF 6 SHINY BRONZE
12.5W x 20.5H x 10RH x 7RW
Box Quantity "10bars"
AL : 7



PF 6 SHINY GOLD
12.5W x 20.5H x 10RH x 7RW
Box Quantity "10bars"
AL : 7



PF 6 SHINY PEWTER
12.5W x 20.5H x 10RH x 7RW
Box Quantity "10bars"
AL : 7



PF 6 SHINY SILVER
12.5W x 20.5H x 9RH x 7RW
Box Quantity "10bars"
AL : 7



PF 7 BRUNSWICK GREEN
12.5W x 16H x 9RH x 7RW
Box Quantity "10bars"
AL : 3



PF 7 SHINY GOLD
12.5W x 16H x 9RH x 7RW
Box Quantity "10bars"
AL : 6



PF 7 MATT BLACK
12.5W x 16H x 9RH x 7RW
Box Quantity "10bars"
AL : 1



PF 7 MATT SILVER
12.5W x 16H x 9RH x 7RW
Box Quantity "10bars"
AL : 4



PF 7 SHINY BLACK
12.5W x 16H x 9RH x 7RW
Box Quantity "10bars"
AL : 8



PF 7 SHINY BRONZE
12.5W x 16H x 9RH x 7RW
Box Quantity "10bars"
AL : 6



PF 7 GOLDM
12.5W x 16H x 9RH x 7RW
Box Quantity "10bars"
AL : 4



PF 7 PEWTER
12.5W x 16H x 9RH x 7RW
Box Quantity "10bars"
AL : 6



PF 7 RED
12.5W x 16H x 9RH x 7RW
Box Quantity "10bars"
AL : 3



PF 7 SILBR
12.5W x 16H x 9RH x 7RW
Box Quantity "10bars"
AL : 6



PF 7 WHI
12.5W x 16H x 9RH x 7RW
Box Quantity "10bars"
AL : 3



PF 7 WEDGE
12.5W x 16H x 9RH x 7RW
Box Quantity "10bars"
AL : 3



PF16 BLK
35W X 16.5H x 10.5RH x 8RW
Box Quantity "3bars"
AL : 10



PF16 CHAMPAGNE
35W X 16.5H x 10.5RH x 8RW
Box Quantity "3bars"
AL : 10



PF16 GOLD
35W X 16.5H x 10.5RH x 8RW
Box Quantity "3bars"
AL : 10



PF16 BRONZE
35W X 16.5H x 10.5RH x 8RW
Box Quantity "3bars"
AL : 10



PF16 PEWTER
35W X 16.5H x 10.5RH x 8RW
Box Quantity "3bars"
AL : 10



PF16 SILV
35W X 16.5H x 10.5RH x 8RW
Box Quantity "3bars"
AL : 10



OP 2060 RAW
20W x 60H x 53RH x 6RW
Box Quantity "90mts"
PCU : 42



PF16 SILVM
35W X 16.5H x 10.5RH x 8RW
Box Quantity "3bars"
AL : 10



OP408-35RAW
19W x 35H x 30RH x 5.5RW
Box Quantity "100mts"
PCU : 29



PF16 SILV BR
35W X 16.5H x 10.5RH x 8RW
Box Quantity "3bars"
AL : 10



OP 1938 RAW
19W x 38H x 30RH x 7RW
Box Quantity "140mts"
PCU : 20



OP 1320 RAW
13W x 20H x 15RH x 5RW
Box Quantity "400mts"
PCU : 10



CM 2037 RAW
20Wx37Hx31RH x 6RW
Box Quantity "88mts"
PCU : 17



OP 2020 RAW
20W x 20H x 14RH x 5.5RW
Box Quantity "220mts"
PCU : 12



OP 2845 RAW
28W x 45H x 34RH x 9RW
Box Quantity "70mts"
PCU : 46



OP 1927 RAW
19W x 27H x 21.5RH x 7RW
Box Quantity "150mts"
PCA : 34



OP 6028 RAW
28W x 60H x 35RH x 21RW
Box Quantity "80mts"
PCU : 47



• RAW 24 OAK
19W x 41H x 12RH x 6RW
Box Quantity "50mts"
PCA : 40



OP 6029 RAW
29W x 60H x 45RH x 22RW
Box Quantity "80mts"
PCU : 47



OP 3020 RAW
30W x 20H x 12RH x 6RW
Box Quantity "140mts"
PCU : 15



• RAW 4113 OAK
13W x 41H x 8RH x 4RW
Box Quantity "80mts"
PCA:28



• RAW 711 OAK
16W x 19H x 6RH x 6RW
Box Quantity "250mts"
PCA : 13



• RAW 4030 OAK
16W x 31H x 25RH x 8RW
Box Quantity "100mts"
PCA: 22



• RAW 1 OAK
19W x 41H x 34RH x 6RW
Box Quantity "85mts"
PCA: 27



• RAW 408-35 OAK
20W x 36H x 30RH x 7RW
Box Quantity "100mts"
PCA:32



• RAW 407 OAK
20W x 21H x 17RH x 6.5RW
Box Quantity "150mts"
PCA : 13



• RAW 2060 OAK
22W x 60H x 51RH x 7RW
Box Quantity "55mts"
PCA:46



• RAW 4042 OAK
25W x 45H x 35RH x 7RW
Box Quantity "35mts"
PCA:44



• RAW 150 OAK
25W x 40H x 15RH x 7RW
Box Quantity "50mts"
PCA : 44



• RAW 152 OAK
25W x 60H x 15RH x 7RW
Box Quantity "40mts"
PCA:46



• RAW 402 OAK
30W x 19H x 13RH x 6RW
Box Quantity "100mts"
PCA:24



• RAW 6 OAK
32W x 42H x 35RH x 22RW
Box Quantity "30mts"
PCA : 50



• RAW 604 OAK
32W x 32H x 23RH x 7RW
Box Quantity "100mts"
PCA:44



• RAW 2 OAK
34W x 55H x 45RH x 24RW
Box Quantity "35mts"
PCA : 46



• RAW 23 OAK
34W x 55H x 45RH x 26RW
Box Quantity "50mts"
PCA : 46



• RAW S12X6 OAK
12W x 6H
Box Quantity "200 mts"
PCA: 22

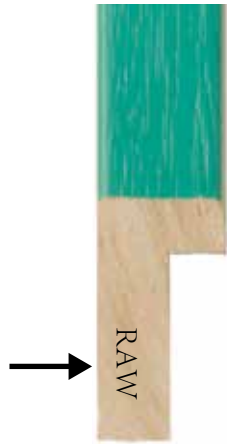

• RAW 4030OAK AQ
16W x 31H x 25RH x 8RW
Box Quantity "100mts"
PCA: 23



• RAW 4030OAK BK
16W x 31H x 25RH x 8RW
Box Quantity "100mts"
PCA: 23



• RAW 4030OAK LI
16W x 31H x 25RH x 8RW
Box Quantity "100mts"
PCA: 23



• RAW 4030OAK OR
16W x 31H x 25RH x 8RW
Box Quantity "100mts"
PCA: 23



• RAW 4030OAK WH
16W x 31H x 25RH x 8RW
Box Quantity "100mts"
PCA: 23

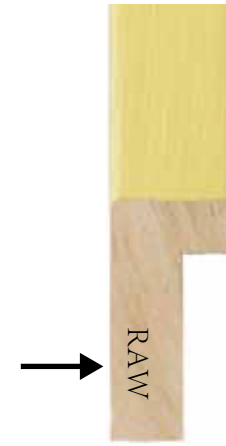

• RAW 4030OAK YE
16W x 31H x 25RH x 8RW
Box Quantity "100mts"
PCA: 23



• RAW 4030OAK RED
16W x 31H x 25RH x 8RW
Box Quantity "100mts"
PCA: 23



• RAW 4113 OAK
13W x 41H x 8RH x 4RW
Box Quantity "80mts"
PCA:30



• RAW 3 OAK
13W x 48H x 43RH x 5RW
Box Quantity "110 mts"
PCA: 46



• RAW 4030 OAK
16W x 31H x 25RH x 8RW
Box Quantity "100mts"
PCA: 21



• RAW 1S OAK BK
19W x 41H x 34RH x 6RW
Box Quantity "85mts"
PCA: 44



• RAW 1S OAK BRO
19W x 41H x 34RH x 6RW
Box Quantity "85mts"
PCA: 44



• RAW 1S OAK WH
19W x 41H x 34RH x 6RW
Box Quantity "85mts"
PCA: 44



• RAW 1 OAK
19W x 41H x 34RH x 6RW
Box Quantity "85mts"
PCA: 40



• RAW 1 BWOOD
19W x 41H x 34RH x 6RW
Box Quantity "85mts"
PCA: 47



• RAW S20X6 OAK
20W x 6H
Box Quantity "200mts"
PCA:22



• RAW S20X8 OAK
20W x 8H
Box Quantity "200mts"
PCA:22



• RAW 407 OAK
20W x 21H x 17RH x 6.5RW
Box Quantity "150mts"
PCA : 20



• RAW 402 OAK
30W x 19H x 13RH x 6RW
Box Quantity "100mts"
PCA:24



• OP4020RAW
40W x 20H x 12RH x 8RW
Box Quantity "96mts"
PCU : 20

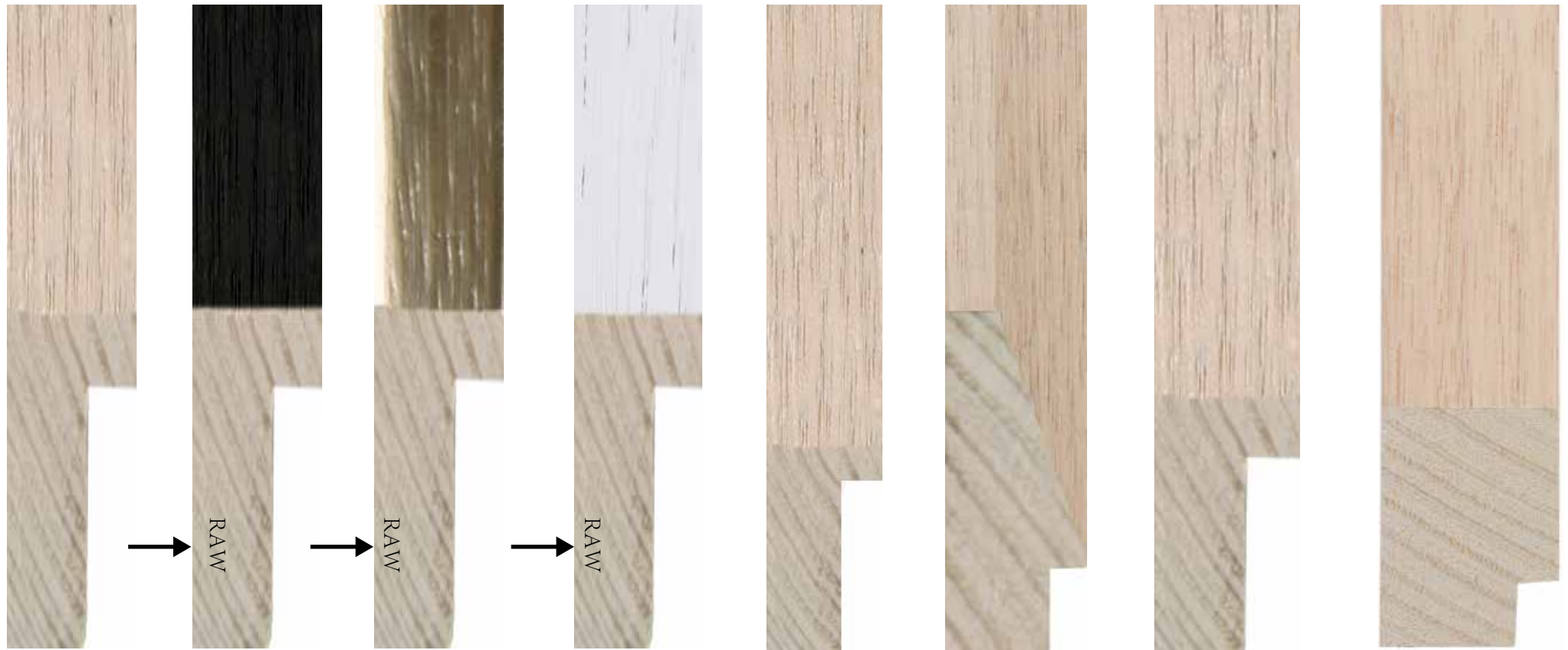

• RAW 2060 OAK
22W x 60H x 51RH x 7RW
Box Quantity "55mts"
PCA:50

• RAW 2060 OAK BLK
22W x 60H x 51RH x 7RW
Box Quantity "55mts"
PCA:51

• RAW 2060 OAK BR
22W x 60H x 51RH x 7RW
Box Quantity "55mts"
PCA:51

• RAW 2060 OAK WH
22W x 60H x 51RH x 7RW
Box Quantity "55mts"
PCA:51

• RAW 408-35 OAK
20W x 36H x 30RH x 7RW
Box Quantity "100mts"
PCA:37

• RAW 152 OAK
25W x 60H x 15RH x 7RW
Box Quantity "40mts"
PCA:51

• RAW 4042 OAK
25W x 45H x 35RH x 7RW
Box Quantity "35mts"
PCA:48

• RAW 4043 OAK
30W x 42H x 12RH x 7RW
Box Quantity "50mts"
PCA : 45

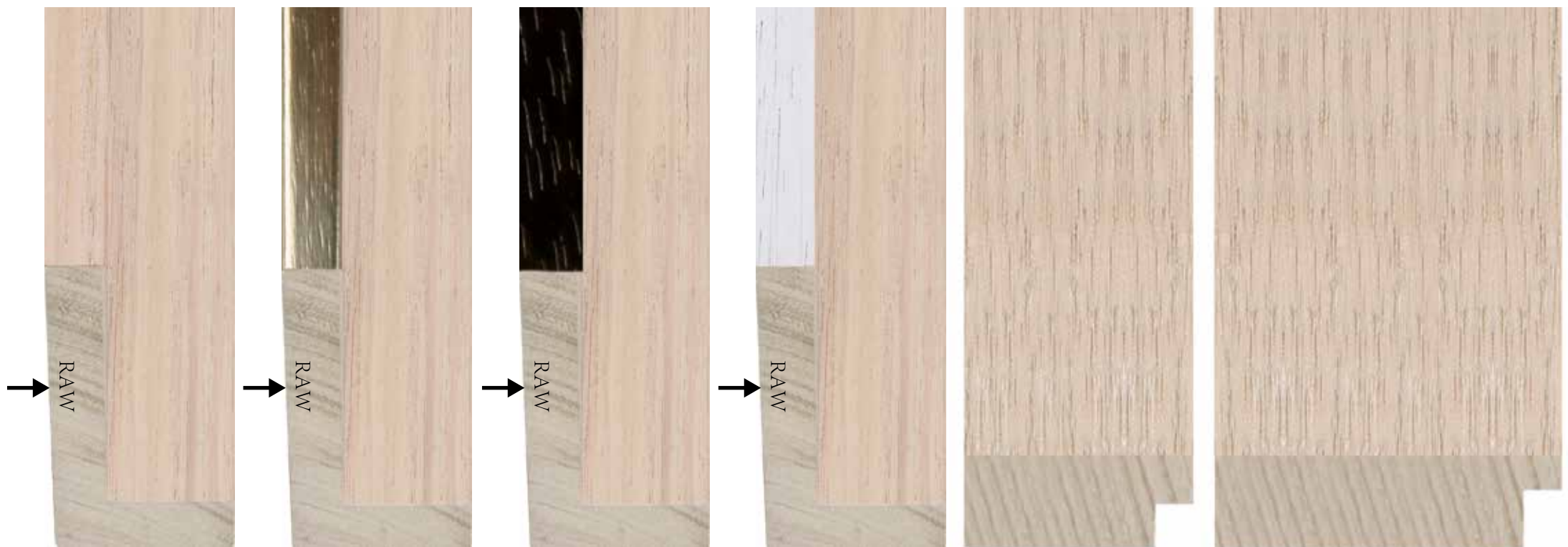

• RAW 2 OAK
34W x 55H
Box Quantity "35mts"
PCA : 50

• RAW 2 OAK BRONZE
34W x 55H
Box Quantity "35mts"
PCA : 51

• RAW 2 OAK BK
34W x 55H
Box Quantity "35mts"
PCA : 51

• RAW 2 OAK WH
34W x 55H
Box Quantity "35mts"
PCA : 51

• RAW 506 OAK
42W x 19H x 8RH x 7RW
Box Quantity "60mts"
PCA : 36

• RAW 706 OAK
64W x 19H x 12.5RH x 7RW
Box Quantity "72mts"
PCA:46



DISCONTINUED MOULDINGS

50% OFF BOX QTY

QUALITY AND PRICE

★ Stock availability at the time of printing this catalogue

50% OFF BOX QTY



• APM 148 BK
13.5W x 42H x 7.5RH
Box Quantity "144mts"
STOCK:529 M



CH 6002/3
19W x 29H x 25RH
Box Quantity "160mts"
STOCK:109 M



• APM 408-35 NB
20W x 37H x 31RH
Box Quantity "100mts"
STOCK:139 M



• APM 3242 BK
20W x 42H x 15RH
Box Quantity "144mts"
STOCK:583 M



• APM 3268 BLACK
20W x 68H x 12RH
Box Quantity "84mts"
STOCK:372 M



CM 020-282-001 GOLD
20.5W x 13.5H x 9RH
Box Quantity "300mts"
STOCK:50 M



• APM 12 RGPK
22W x 18H x 8.5RH
Box Quantity "240mts"
STOCK:140 M



CH 6017-2 PINK
22.5W x 22H x 12RH
Box Quantity "200mts"
STOCK:389 M



CH 6017-4 GREEN
22.5W x 22H x 12RH
Box Quantity "200mts"
STOCK:366 M



CM 1502- Gloss
23W x 21H x 13RH
Box Quantity "190mts"
STOCK:26M



• APM 83 BMG
23W x 15H x 9RH
Box Quantity "216mts"
STOCK:1052 M



BC 2179 SILVER
25W x 21H x 15R
Box Quantity "60mts"
STOCK:343 M



CH 2035/1
25W x 32H x 23RH
Box Quantity "135mts"
STOCK:92 M



• APM 21 AGPK
26W x 15H x 7RH
Box Quantity "135mts"
STOCK:241 M



• APM 4042 NB
28W x 45H x 40RH
Box Quantity "60mts"
STOCK:281 M



CM 2252-3 SILVER
29W x 41H x 30RH
Box Quantity "90mts"
STOCK:232 M



CM 2252-4 GUNMETAL
29W x 41H x 30RH
Box Quantity "90mts"
STOCK:136 M



CM 2252-5 FRDBR
29W x 41H x 30RH
Box Quantity "90mts"
STOCK:806 M



BC 2401 GOLD
30W x 47.5H x 39R
Box Quantity "50mts"
STOCK:33 M



BC 2402 SILVER
30W x 47.5H x 39R
Box Quantity "50mts"
STOCK:417 M



• APM 29 WW
30W x 22H x 14RH
Box Quantity "72mts"
STOCK:262 M

50% OFF BOX QTY



• CH 6004/1
30W x 13.5H x 8.5RH
Box Quantity "194.4mts"
STOCK:110 M



• DC 513 GL
31W x 23H x 17RH
Box Quantity "130mts"
STOCK:115 M



• APM 129 A/T
32W x 15H x 9RH
Box Quantity "144mts"
STOCK:323 M



• APM 870 TS
32W x 20H x 9RH
Box Quantity "100mts"
STOCK:103 M



• APM 32 BKG
32W x 22H x 10RH
Box Quantity "120mts"
STOCK:643 M



• APM 32 BKS
32W x 22H x 10RH
Box Quantity "120mts"
STOCK:84 M



• APM 32 SPG
32W x 22H x 10RH
Box Quantity "120mts"
STOCK:219 M



• APM 5 WG
32W x 22H x 6RH
Box Quantity "120mts"
STOCK:218 M



• APM 5 EMG
32W x 22H x 6RH
Box Quantity "120mts"
STOCK:261 M



• APM 131 A/T
32W x 20H x 13RH
Box Quantity "120mts"
STOCK:1535 M



• APM 315 NBBK
32W x 20H x 10RH
Box Quantity "120mts"
STOCK:203 M



• APM 315 DWBK
32W x 20H x 10RH
Box Quantity "120mts"
STOCK:304 M



• APM 315 WBK
32W x 20H x 10RH
Box Quantity "120mts"
STOCK:366 M



• APM 315 GOBK
32W x 20H x 10RH
Box Quantity "120mts"
STOCK:480 M



• APM 280 NB
32W x 34H
Box Quantity "48mts"
STOCK:147 M



• APM 280 W
32W x 34H
Box Quantity "48mts"
STOCK:166 M



• CM 722 MB
32W x 21H x 13.5RH
Box Quantity "140mts"
STOCK:48 M

• APM Australian Made

50% OFF BOX QTY



CH 2051/2
32.5W x 29.5H x 11.5RH
Box Quantity "115mts"
STOCK:136 M



CM 2999-1 BG
33W x 22H x 14RH
Box Quantity "120mts"
STOCK:1276 M



• APM 590 GOLD
33W x 14H x 9RH
Box Quantity "100mts"
STOCK:138 M



CW 300-3 NB
34W x 12H x 8RH
Box Quantity "200mts"
STOCK:3153 M



CH 6003-3
35W x 21H x 11RH
Box Quantity "108mts"
STOCK:690 M



CH 6000/ 1
37W x 24.5H x 12.5RH
Box Quantity "96mts"
STOCK:318 M



• APM 3410 DWG
33W x 68H x 58RH
Box Quantity "54mts"
STOCK:168 M



• APM 126 GNAG
37W x 22H x 10RH
Box Quantity "90mts"
STOCK:12 M



• APM 126 RGPK
37W x 22H x 10RH
Box Quantity "90mts"
STOCK:192 M



• APM 3511 RBL
40W x 20H x 8RH
Box Quantity "90mts"
STOCK:345 M



• APM 3511 YL
40W x 20H x 8RH
Box Quantity "90mts"
STOCK:300 M



• APM 3842 WH
40W x 20H x 14RH
Box Quantity "80mts"
STOCK:25 M



• APM 3842 NB
40W x 20H x 14RH
Box Quantity "80mts"
STOCK:1159 M



• APM 3842 W
40W x 20H x 14RH
Box Quantity "80mts"
STOCK:559 M



• APM 3840 RUSSAN WALNUT
40W x 20H x 14RH
Box Quantity "80mts"
STOCK:227 M

50% OFF BOX QTY



CM 960 MBS
40W x 22H x 17RH
Box Quantity "122mts"
STOCK:1217 M



BC 209 Silver
40W x 21H x 15R
Box Quantity "60mts"
STOCK:132 M



BC 208 GOLD
40W x 21H x 15R
Box Quantity "80mts"
STOCK:194 M



• APM 47 AAN
42W x 20H x 9RH
Box Quantity "90mts"
STOCK:318 M



• APM 670 RDWH
42W x 20H x 10RH
Box Quantity "90mts"
STOCK:276 M



• APM 670 NAWH
42W x 20H x 10RH
Box Quantity "90mts"
STOCK:371 M



• APM 3513 GOG
42W x 20H x 7RH
Box Quantity "90mts"
STOCK:100 M



• APM 910-4
42W x 20H x 14RH
Box Quantity "90mts"
STOCK:51 M



• APM 316 NBBK
42W x 20H x 10RH
Box Quantity "90mts"
STOCK:235 M



• APM 316 DWBK
42W x 20H x 10RH
Box Quantity "90mts"
STOCK:451 M



• APM 316 WBK
42W x 20H x 10RH
Box Quantity "90mts"
STOCK:343 M



• APM 316 GOBK
42W x 20H x 10RH
Box Quantity "90mts"
STOCK:286 M



• APM 800 W
42W x 35H x 11RH
Box Quantity "90mts"
STOCK:165 M



• APM 56 AT
42W x 17H x 12RH
Box Quantity "108mts"
STOCK:1204 M



CH 2087/2
42W x 25.5H x 7RH
Box Quantity "64mts"
STOCK:75 M

• APM Australian Made

50% OFF BOX QTY



• APM 120 EBRL
42W x 19H x 9RH
Box Quantity "90mts"
STOCK:1209 M



• APM 301 BRL
42W x 19H x 12RH
Box Quantity "90mts"
STOCK:200 M



• APM 179 ET
42W x 19H x 10RH
Box Quantity "90mts"
STOCK:200 M



• APM 103 BKWH
42W x 20H x 12RH
Box Quantity "90mts"
STOCK:481 M



• APM 609 TALLOWOOD
42W x 19H x 10.5RH
Box Quantity "90mts"
STOCK:400 M



• APM 910-2
42W x 20H x 14RH
Box Quantity "90mts"
STOCK:656 M



• APM 109 AM
43W x 18H x 10RH
Box Quantity "108mts"
STOCK:175 M



• APM 109 SG
43W x 18H x 10RH
Box Quantity "108mts"
STOCK:197 M



CM 4061 GF
44W x 23H x 10RH
Box Quantity "100mts"
STOCK:134 M

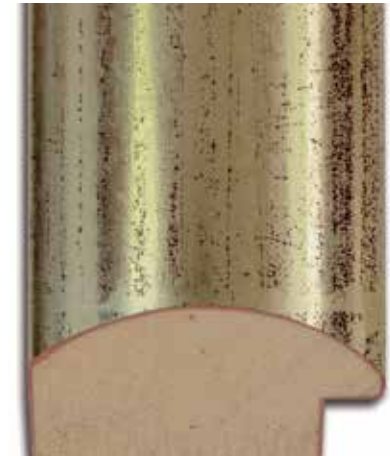

BC 2348 GOLD
47W x 21.5H x 8.5R
Box Quantity "80mts"
STOCK:113 M



CM 3000-1 BG
47W x 22H x 15RH
Box Quantity "80mts"
STOCK:257 M



CH 6018-7 CHARCOAL
49W x 26H x 14RH
Box Quantity "60mts"
STOCK:208 M



CH 6018-2 CLEAR
49W x 26H x 14RH
Box Quantity "60mts"
STOCK:194 M



CH 6018-3 RED
49W x 26H x 14RH
Box Quantity "60mts"
STOCK:193 M

• APM Australian Made

50% OFF BOX QTY



• APM 10 EGO
50W x 19H x 9RH
Box Quantity "96mts"
STOCK:322 M



• APM 168 GOB
50W x 18H x 12RH
Box Quantity "80mts"
STOCK:120 M



CM 4092 GF
51W x 29H x 10RH
Box Quantity "60mts"
STOCK:236 M



CM 4011 SF
51W x 29H x 10RH
Box Quantity "60mts"
STOCK:428 M



• APM 164 GOG
54W x 20H x 9.5RH
Box Quantity "72mts"
STOCK:388 M



• APM 555 ENB
55W x 19H x 12RH
Box Quantity "72mts"
STOCK:355 M



• APM 555 EGO
55W x 19H x 12RH
Box Quantity "72mts"
STOCK:108 M



• APM 104 TEDDY
56W x 21H x 16.5RH
Box Quantity "60mts"
STOCK:97 M



• APM 3710 DWBB
56W x 20H x 9RH
Box Quantity "72mts"
STOCK:268 M



• APM 3710 DW
56W x 20H x 9RH
Box Quantity "72mts"
STOCK:142 M



• APM 68 AT
56W x 20H x 12RH
Box Quantity "108mts"
STOCK:1380 M



• APM 560 YLWH
56W x 20H x 7.5RH
Box Quantity "60mts"
STOCK:275 M

50% OFF BOX QTY



• APM 630 NB
56W x 20H x 8RH
Box Quantity "72mts"
STOCK:239 M



• APM 230 GO
56W x 20H x 12RH
Box Quantity "72mts"
STOCK:135 M



• APM 560 DW
56W x 20H x 7.5RH
Box Quantity "60mts"
STOCK:482 M



• APM 99 A/W
56W x 20H x 10RH
Box Quantity "66mts"
STOCK:441 M



CZ 3155-2114
56.5W x 34H x 19RH
Box Quantity "70mts"
STOCK:180 M



• APM 121 GRWH
57W x 20H x 10RH
Box Quantity "72mts"
STOCK:144 M



• APM 121 ALBAL
57W x 20H x 12RH
Box Quantity "72mts"
STOCK:273 M



• APM 143 EBL
57W x 20H x 7RH
Box Quantity "72mts"
STOCK:207 M



CH 2041/1
58W x 20H x 10RH
Box Quantity "75mts"
STOCK:224 M



CS 202-1
58W x 45H x 28RH
Box Quantity "33mts"
STOCK:318 M



CH 2006/4
60W x 30.5H x 17RH
Box Quantity "45mts"
STOCK:79 M

• APM Australian Made

50% OFF BOX QTY

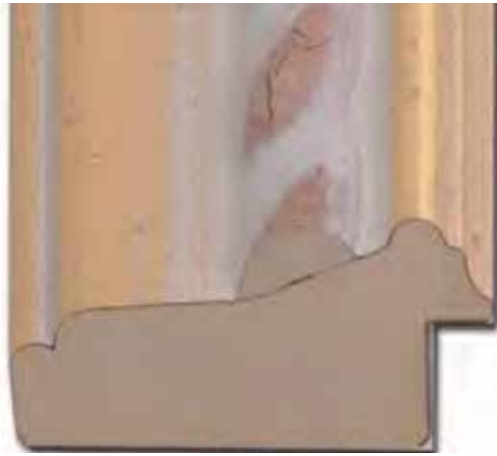

CH 2006/1
60W x 30.5H x 17RH
Box Quantity "45mts"
STOCK:104 M



CH 2006/2
60W x 30.5H x 17RH
Box Quantity "45mts"
STOCK:138 M



CH 2006/3
60W x 30.5H x 17RH
Box Quantity "45mts"
STOCK:75 M



CH 6007-5 CHARCOAL
61W x 20.5H x 14RH
Box Quantity "66mts"
STOCK:320 M



• APM 57 W
61W x 20H x 12RH
Box Quantity "65mts"
STOCK:396 M



• APM 2016 EDW
62W x 20H x 7RH
Box Quantity "60mts"
STOCK:103 M

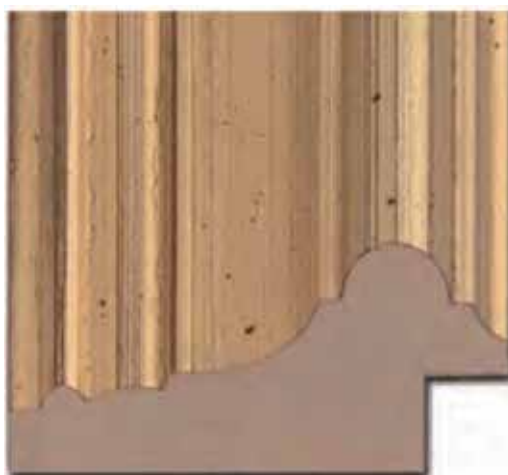

CH 2015/1
63.5W x 30H x 13RH
Box Quantity "45mts"
STOCK:138 M



• APM 920-5
64W x 20H x 12RH
Box Quantity "54mts"
STOCK:178 M



• APM 102 BKWH
64W x 19H x 12.5RH
Box Quantity "72mts"
STOCK:170 M

• APM Australian Made

50% OFF BOX QTY



• APM 920-4
64W x 20H x 12RH
Box Quantity "54mts"
STOCK:275 M



• APM 69 GO
64W x 20H x 13RH
Box Quantity "60mts"
STOCK:108 M



• APM 134 GYG
65W x 20H x 12RH
Box Quantity "60mts"
STOCK:325 M



• APM 113 AW
65W x 20H x 13RH
Box Quantity "54mts"
STOCK:1550 M



• APM 111 CD
65W x 30H x 10RH
Box Quantity "48mts"
STOCK:230 M



• APM 111 AW
65W x 30H x 10RH
Box Quantity "48mts"
STOCK:1447 M



• APM 540 WHBR
65W x 20H x 14RH
Box Quantity "60mts"
STOCK:508 M



• APM 1050 BR
65W x 21H x 13RH
Box Quantity "40mts"
STOCK:200 M



• APM 1050 Gunmetal
65W x 21H x 13RH
Box Quantity "40mts"
STOCK:323 M

50% OFF BOX QTY



• APM 167 AT
65W x 27H x 7RH
Box Quantity "50mts"
STOCK:1491 M



• APM 80 EWG
65W x 28H x 16RH
Box Quantity "36mts"
STOCK:1297 M



• APM 134 WHG
65W x 20H x 12RH
Box Quantity "60mts"
STOCK:153 M



• APM 111 ATBN
65W x 30H x 10RH
Box Quantity "48mts"
STOCK:523 M



• APM 350-4
66W x 20.5H x 10RH
Box Quantity "54mts"
STOCK:232 M



• APM 166 GOB
66W x 17H x 10RH
Box Quantity "54mts"
STOCK:1109 M



• APM 350-2
66W x 20.5H x 10RH
Box Quantity "54mts"
STOCK:292 M



• APM 350-5 BK
66W x 20.5H x 10RH
Box Quantity "47mts"
STOCK:154 M



• APM 92 CD
67W x 20H x 10RH
Box Quantity "60mts"
STOCK:518 M

• APM Australian Made

50% OFF BOX QTY

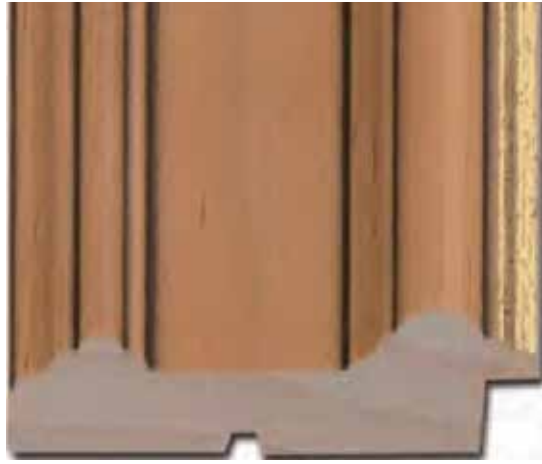

• APM 92 ATG
67W x 20H x 10RH
Box Quantity "60mts"
STOCK:435 M



• APM 92 AT
67W x 20H x 10RH
Box Quantity "54mts"
STOCK:90 M

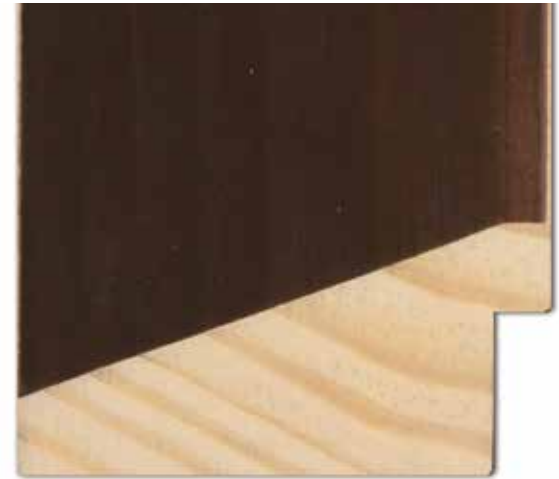

• APM 715 NB
68W x 34H x 27RH
Box Quantity "38mts"
STOCK:135 M



• APM 611 EMULBERRY
68W x 19H x 12.5RH
Box Quantity "63mts"
STOCK:257 M



• APM 132 EAW
68W x 20H x 10RH
Box Quantity "66mts"
STOCK:941 M



• APM 132 EALBAL
68W x 20H x 10RH
Box Quantity "66mts"
STOCK:105 M



• APM 3868 NB
68W x 20H x 12RH
Box Quantity "54mts"
STOCK:130 M



• APM 3868 W
68W x 20H x 12RH
Box Quantity "54mts"
STOCK:686 M



• APM 3868 GO
68W x 20H x 12RH
Box Quantity "54mts"
STOCK:728 M

50% OFF BOX QTY



• APM 101 BL
68W x 20H x 10RH
Box Quantity "60mts"
STOCK:814 M

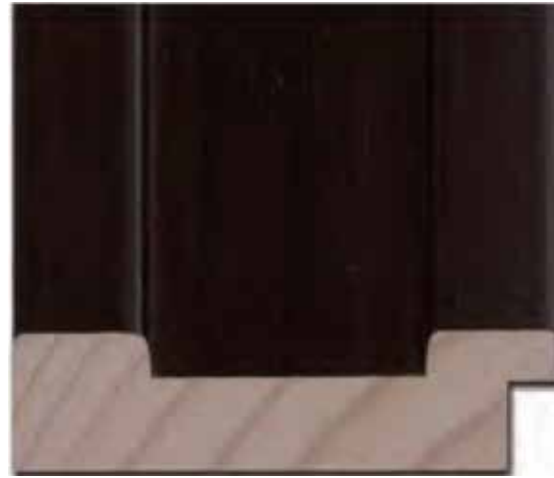

• APM 3868 BK
68W x 20H x 12RH
Box Quantity "54mts"
STOCK:273 M



• APM 101 EAWBLG
69W x 20H x 10RH
Box Quantity "60mts"
STOCK:188 M



• APM 101 EAWWHG
69W x 20H x 10RH
Box Quantity "60mts"
STOCK:643 M



• APM 70 GO
70W x 26H x 19RH
Box Quantity "54mts"
STOCK:128 M



CM 3001-2 BS
77W x 20H x 11RH
Box Quantity "60mts"
STOCK:208 M



CZ 4177-0062
78W x 40H x 9RH
Box Quantity "72mts"
STOCK:174 M



• APM 580 T
80W x 32H x 9RH
Box Quantity "36mts"
STOCK:195 M

50% OFF BOX QTY



• APM 580 W
80W x 32H x 9RH
Box Quantity "36mts"
STOCK:134 M



• APM 114 ALBAL
87W x 19H x 10RH
Box Quantity "42mts"
STOCK:798 M



• APM 616 FB
88W x 20H x 12RH
Box Quantity "36mts"
STOCK:678 M



• APM 720 NB
88W x 34H x 27RH
Box Quantity "31mts"
STOCK:263 M

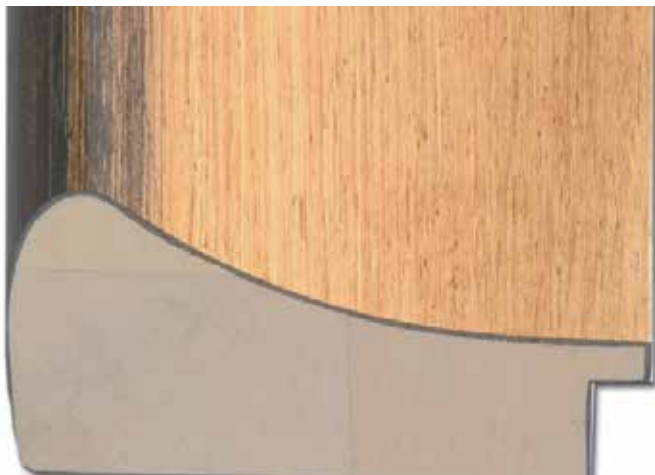

CH 8007/1
88W x 40H x 7.5RH
Box Quantity "28mts"
STOCK:1250 M



CH 8007/2
88W x 40H x 7.5RH
Box Quantity "28mts"
STOCK:34 M

50% OFF BOX QTY



• APM 850 NB
90W x 32H x 17RH
Box Quantity "30mts"
STOCK:383 M



• APM 850 DW
90W x 32H x 17RH
Box Quantity "30mts"
STOCK:746 M



• APM 507 EWH
90W x 19H x 12RH
Box Quantity "36mts"
STOCK:182M



• APM 850 W
90W x 32H x 17RH
Box Quantity "30mts"
STOCK:380 M



• APM 944 GO
90W x 32H x 7.5RH
Box Quantity "30mts"
STOCK:283 M



• APM 123 AT
110W x 30H x 18RH
Box Quantity "24mts"
STOCK:651 M

50% OFF BOX QTY



CH 462-5217
11W x 42H
Box Quantity "63mts"
STOCK:2438 M



CPS 8001-1
20W x 23H x 17R
Box Quantity "162mts"
STOCK:1180 M



CP 300 - 2WH Cream
20W x 31H x 24.5RH
Box Quantity "200mts"
STOCK:114 M



CH 2284-A
24W x 17.5H x 6.5RH
Box Quantity "205.2mts"
STOCK:287 M



CIS 013-1 BRONZE
30W x 21.5H x 14RH
Box Quantity "120mts"
STOCK:9529 M



CH 2180
30W x 24H x 6RH
Box Quantity "102.6mts"
STOCK:2730 M



286 SILVER
31W x 14H x 8RH
Box Quantity "185mts"
STOCK:2909 M



CH 2311-4
32W x 23H x 9.5RH
Box Quantity "128.5mts"
STOCK:1538 M



CH 003 GOLD
33W x 13H x 6RH
Box Quantity "188.5mts"
STOCK:148 M



CH 247-A 189
38Wx41Hx9.5RH
Box Quantity "71mts"
STOCK:1837 M



CG 203-1
38Wx34.5Hx17R
Box Quantity "72mts"
STOCK:108 M



CG 203-2
38Wx34.5Hx17R
Box Quantity "72mts"
STOCK:947 M



CG 203-3
38Wx34.5Hx17R
Box Quantity "72mts"
STOCK:443 M



CG 203-4
38Wx34.5Hx17R
Box Quantity "72mts"
STOCK:455 M



CG 200 - 2
38W x 18H x 13RH
Box Quantity "121mts"
STOCK:414 M



CG 200 - 3
38W x 18H x 13RH
Box Quantity "121mts"
STOCK:1878 M



CH 5002-1
39W x 22H x 9RH
Box Quantity "121mts"
STOCK:920 M



CH 2320 GOLD
39.5Wx20.5Hx11R
Box Quantity "99.75mts"
STOCK:3065 M



CH 6501
40Wx14.5Hx9.5RH
Box Quantity "103.3mts"
STOCK:461 M

50% OFF BOX QTY Synthetic Mouldings



CH 7 LB
42Wx22Hx10RH
Box Quantity "91.2mts"
STOCK:189 M



CH 6607
45W x 38H x 12RH
Box Quantity "69.9mts"
STOCK:133 M



CH 4900 G
48.5W x 16H x 9RH
Box Quantity "116mts"
STOCK:245 M



SCRATCH
RESISTANT

CH 3543 - 3
49W x 16H x 7.5RH
Box Quantity "90mts"
STOCK:17 M



SF 647-176
50W x 31H x 18RH
Box Quantity "50mts"
STOCK:928 M



CH 2587(SMALL) GOLD
50W x 33H x 10RH
Box Quantity "48.4mts"
STOCK:1167 M



SF 648
50W x 25.5H x 15RH
Box Quantity "59.8mts"
STOCK:430 M



CH 2358 GOLD
50W x 37H x 11RH
Box Quantity "45.6mts"
STOCK:112 M

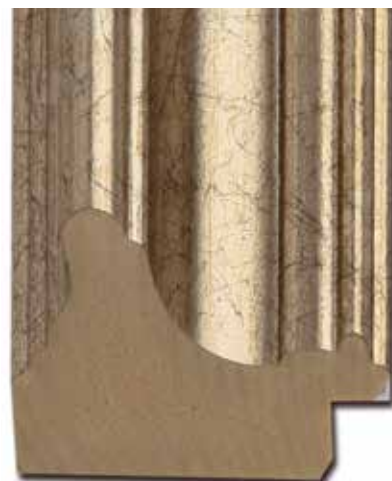

CH 2358 SILVER
50W x 37H x 11RH
Box Quantity "45.6mts"
STOCK:202 M



CH 95 C SILVER
50Wx18Hx10.5R
Box Quantity "79.8mts"
STOCK:307 M



CH 176
50Wx18Hx8.5R
Box Quantity "80mts"
STOCK:363 M



CH 6100 BK
51Wx20Hx11R
Box Quantity "89.9mts"
STOCK:398M

50% OFF BOX QTY Synthetic Mouldings



CH 6100 CHOCOLATE
51Wx20Hx11R
Box Quantity "89.9mts"
STOCK:24 M



CIS 246-1 BRONZE
57Wx20Hx14.5RH
Box Quantity "71mts"
STOCK:2324 M



CIS 246-2 GUNMETAL
57Wx20Hx14.5RH
Box Quantity "71mts"
STOCK:452 M



CH 389-V 3211
58Wx32Hx10R
Box Quantity "57mts"
STOCK:750 M

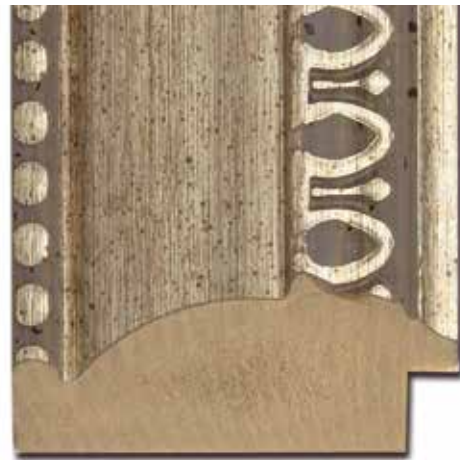

SF 665-180
59Wx26Hx11RH
Box Quantity "69.6mts"
STOCK:291 M



CH 110 SILVER SMALL
59Wx19Hx7RH
Box Quantity "81.2mts"
STOCK:213 M



CH 402 S 177
63.5W x 37.5H x 10RH
Box Quantity "45mts"
STOCK:966 M



CH 2405/4 SILVER
64W x 32.5H x 17.5RH
Box Quantity "39.9mts"
STOCK:584 M



CH 7702
68W x 33.5H x 10.5RH
Box Quantity "52.2mts"
STOCK:523 M



CH 401-S 214
70W x 50H x 15RH
Box Quantity "34.2mts"
STOCK:170 M

50% OFF BOX QTY Synthetic Mouldings

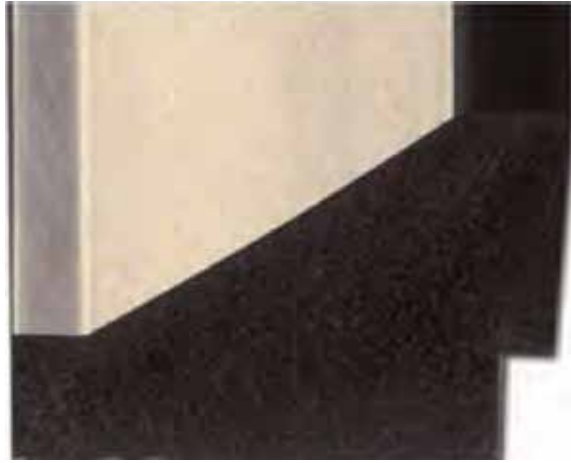

CH 401-S 372
70W x 50H x 15RH
Box Quantity "34.2mts"
STOCK:302 M



SF 662-176
73Wx35Hx18.5RH
Box Quantity "28.5mts"
STOCK:589 M



CIS 155-1 BRONZE
74Wx20Hx12RH
Box Quantity "60mts"
STOCK:1914 M



CH 2160 WHITE
76W x 37H x 12RH
Box Quantity "40mts"
STOCK:1165 M



CH 288-1
76W x 25H x 17RH
Box Quantity "25mts"
STOCK:1504 M



CH 288-2
76W x 25H x 17RH
Box Quantity "25mts"
STOCK:1619 M



CH 9004/2
76.5W x 29.5H x 14RH
Box Quantity "40.6mts"
STOCK:241 M



CP 311 - 4
79W x 39H x 15RH
Box Quantity "34mts"
STOCK:133 M



CH 110 SILVER
80W x 28H x 8.5RH
Box Quantity "37.7mts"
STOCK:593 M

50% OFF BOX QTY Synthetic Mouldings



FM3 NES
80W x 32H x 12.5RH
Box Quantity "28.5mts"
STOCK:219 M

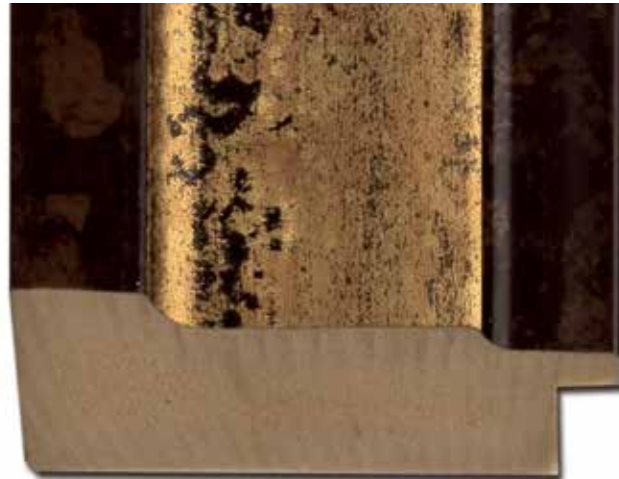

CH 2422 SMALL-6
80W x 24.5H x 12RH
Box Quantity "43.2mts"
STOCK:2108 M



CH 820-1 BLACK
82W x 25H x 8.5RH
Box Quantity "35mts"
STOCK:410 M

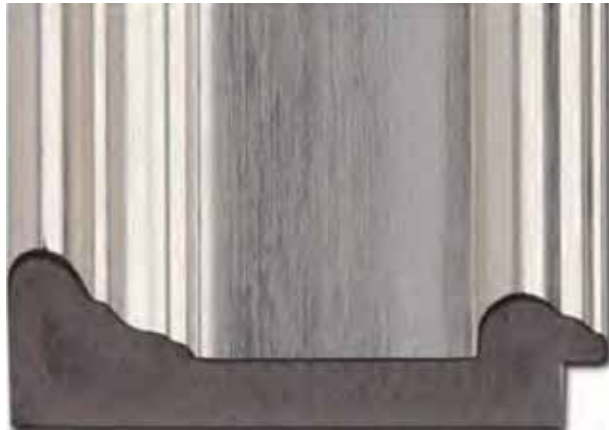

CH 820-2 SILVER
82W x 26H x 8.5RH
Box Quantity "35mts"
STOCK:1060 M



DP 100 GOLD
89W x 31H x 15RH
Box Quantity "29mts"
STOCK:127 M



CH 3336-1
89W x 19H x 9RH
Box Quantity "40mts"
STOCK:118 M



CH 2587 LGE TBN
90W x 35H x 11RH
Box Quantity "30mts"
STOCK:644 M



CH 2422(LARGE) SILVER
120W x 36H x 19RH
Box Quantity "17.1mts"
STOCK:71 M

| ORDER CODE | PG | ORDER CODE | PG | ORDER CODE | PG | ORDER CODE | PG |
|---------------------|-----|-------------------|-----|------------------|-----|-----------------|-----|
| 286 - BLACK | 168 | APM 1 CHARCOAL | 91 | APM 126 GNAG | 186 | APM 174 W | 134 |
| 286 SILVER | 198 | APM 1 COYOTE | 131 | APM 126 RGPK | 186 | APM 174 WG | 134 |
| 386 - BLACK | 168 | APM 1 ZEBRANO | 131 | APM 129 A/T | 185 | APM 174 WHS | 109 |
| 386 SG | 168 | APM 10 EGO | 189 | APM 131 A/T | 185 | APM 179 ET | 188 |
| 595 C GOLD | 175 | APM 101 BL | 195 | APM 132 EALBAL | 194 | APM 19 BK | 90 |
| ACM 12 MG | 123 | APM 101 EAWBLG | 195 | APM 132 EAW | 194 | APM 191 MG | 147 |
| ACM 12 MS | 115 | APM 101 EAWWHG | 195 | APM 134 GYG | 192 | APM 2 BLACK | 161 |
| ACM 19 SS | 119 | APM 102 BKWH | 191 | APM 134 WHG | 193 | APM 2 BRLG | 143 |
| ACM 20 C | 125 | APM 102 GREEN | 136 | APM 139 A / W | 146 | APM 2 CARBON | 161 |
| ACM 20 G | 125 | APM 102 ONYX | 148 | APM 139 WH | 109 | APM 2 CASHEW | 161 |
| ACM 20 M | 125 | APM 102 WBK | 149 | APM 143 EBL | 190 | APM 2 CHALK | 161 |
| ACM 23 C | 124 | APM 102 WHITE | 111 | APM 143 WH | 110 | APM 2 CHARCOAL | 161 |
| ACM 23 SA | 116 | APM 103 BKWH | 188 | APM 148 BK | 184 | APM 2 COYOTE | 161 |
| ACM 28 D | 123 | APM 103 WBK | 146 | APM 150 EBK | 93 | APM 2 WENGE | 161 |
| ACM 31 M | 122 | APM 104 RWH | 111 | APM 150 ECAMEL | 130 | APM 200 BK | 95 |
| ACM 34 IVNG | 164 | APM 104 TEDDY | 189 | APM 150 ECASHEW | 130 | APM 200 WH | 108 |
| ACM 34 IVS | 164 | APM 105 AW | 133 | APM 150 EWH | 107 | APM 2016 EDW | 191 |
| ACM 400 BLK | 97 | APM 1050 BR | 192 | APM 150 RBK | 93 | APM 21 AGPK | 184 |
| ACM 400 MS | 116 | APM 1050 Gunmetal | 192 | APM 150 RDW | 141 | APM 21 BMG | 141 |
| ACM 400 WH | 109 | APM 106 EANW | 144 | APM 151 BK | 90 | APM 23 BK | 161 |
| ACM 44 IVGWL | 164 | APM 107 EANW | 150 | APM 152 CARBON | 93 | APM 230 GO | 190 |
| ACM 44 IVS | 164 | APM 108 AMBL | 143 | APM 152 CHARCOAL | 93 | APM 24 CARBON | 91 |
| ACM 45 GR | 125 | APM 108 AW | 143 | APM 152 COYOTE | 132 | APM 24 CASHEW | 131 |
| ACM 508 LICORI | 158 | APM 108 WH | 108 | APM 152 EBLK | 93 | APM 24 CHALK | 106 |
| ACM 508 STERLI | 157 | APM 108 WWH | 108 | APM 152 ECAMEL | 130 | APM 24 CHARCOAL | 91 |
| ACM 60 IV | 164 | APM 109 AM | 188 | APM 152 ECASHEW | 131 | APM 24 COYOTE | 131 |
| ACM 600 BLK | 101 | APM 109 SG | 188 | APM 152 EOATMEAL | 131 | APM 24 ZEBRANO | 131 |
| ACM 600 MG | 125 | APM 111 ATBN | 193 | APM 152 ESNOW | 131 | APM 268 W | 136 |
| ACM 600 MS | 119 | APM 111 AW | 192 | APM 152 EWHITE | 106 | APM 268 WG | 149 |
| ACM 600 WH | 110 | APM 111 CD | 192 | APM 152 RBK | 93 | APM 268 WH | 111 |
| ACM 61 BLK | 103 | APM 113 AW | 192 | APM 152 RDW | 141 | APM 270 OMOCCA | 163 |
| ACM 63 BLK | 93 | APM 114 ALBAL | 196 | APM 152 RGY | 131 | APM 270 OBK | 163 |
| ACM 690 LICORI | 158 | APM 12 AGBN | 122 | APM 152 WENGE | 141 | APM 270 OBURG | 163 |
| ACM 690 STERLI | 158 | APM 12 AGGY | 122 | APM 153 BKG | 95 | APM 270 OCHAR | 163 |
| ACM 700 BK | 104 | APM 12 RGPK | 184 | APM 153 BKS | 95 | APM 270 OCLEAR | 164 |
| ACM 700 MG | 127 | APM 120 A/T | 134 | APM 153 MBN | 143 | APM 270 OWH | 163 |
| ACM 700 MS | 120 | APM 120 AAN | 146 | APM 153 TBN | 132 | APM 280 BK | 163 |
| ACM 700 WH | 112 | APM 120 EBRL | 188 | APM 163 BRL | 141 | APM 280 NB | 185 |
| ACM 800 BLK | 104 | APM 121 ALBAL | 190 | APM 163 BRLG | 141 | APM 280 W | 185 |
| ACM 800 GM(on left) | 127 | APM 121 AMBN | 148 | APM 164 GOG | 189 | APM 280 WH | 163 |
| ACM 800 MOCCA | 104 | APM 121 GRWH | 190 | APM 166 GOB | 193 | APM 29 WW | 184 |
| ACM 800 SM (below) | 120 | APM 121 TBN | 135 | APM 167 AT | 193 | APM 301 BRL | 188 |
| APM 1 BLACK | 91 | APM 121 WALNUT | 135 | APM 167 AW | 149 | APM 315 DWBK | 185 |
| APM 1 CARBON | 91 | APM 123 AT | 197 | APM 168 GOB | 189 | APM 315 GOBK | 185 |
| APM 1 CASHEW | 130 | APM 1249 MB | 92 | APM 174 BKS | 97 | APM 315 NBBK | 185 |
| APM 1 CHALK | 106 | APM 1249 WH | 106 | APM 174 GO | 134 | APM 315 WBK | 185 |

Index Moulding

| ORDER CODE | PG | ORDER CODE | PG | ORDER CODE | PG | ORDER CODE | PG |
|-----------------|-----|---------------------------|-----|-------------------|-----|--------------------|-----|
| APM 316 DWBK | 187 | APM 37 GLGY | 122 | APM 408 RBK | 90 | APM 560 YLWH | 189 |
| APM 316 GOBK | 187 | APM 37 GLPK | 122 | APM 408 RDW | 140 | APM 569 GR TEA | 135 |
| APM 316 NBBK | 187 | APM 371 BK | 153 | APM 408 RGY | 130 | APM 569 MULB | 135 |
| APM 316 WBK | 187 | APM 371 GOLD | 153 | APM 408-1 | 90 | APM 569 OATM | 135 |
| APM 32 BKG | 185 | APM 371 WH | 153 | APM 408-2 | 106 | APM 569 ONYX | 145 |
| APM 32 BKS | 185 | APM 3710 DW | 189 | APM 408-35 NB | 184 | APM 569 RIVERS | 135 |
| APM 32 SPG | 185 | APM 3710 DWBB | 189 | APM 408-40 CAS | 130 | APM 569 SNOW | 135 |
| APM 320 ASHWOOD | 143 | APM 3715 BK | 100 | APM 408-40 CHA | 91 | APM 569 WHITE | 109 |
| APM 320 NB | 143 | APM 3715 BKSG | 100 | APM 408-40 MOC | 140 | APM 57 W | 191 |
| APM 320 WHITE | 108 | APM 3840 RUSSAN WALNUT | 186 | APM 408-40 NB | 140 | APM 570 GREEN | 136 |
| APM 3242 BK | 184 | APM 3842 NB | 186 | APM 408-40 SA | 130 | APM 570 MULBER | 137 |
| APM 3268 BLACK | 184 | APM 3842 W | 186 | APM 418 BK | 91 | APM 570 OATMEAL | 137 |
| APM 3409 BKG | 95 | APM 3842 WH | 186 | APM 422 BK | 94 | APM 570 ONYX | 149 |
| APM 3409 BKS | 95 | APM 3868 BK | 195 | APM 422 EBK | 94 | APM 570 RIVER | 137 |
| APM 3409 DW | 143 | APM 3868 GO | 194 | APM 422 ECAMEL | 131 | APM 570 SNOW | 137 |
| APM 3409 DWG | 143 | APM 3868 NB | 194 | APM 422 ECASHEW | 132 | APM 570 WHITE | 110 |
| APM 3409 MT | 143 | APM 3868 W | 194 | APM 422 EMULBERRY | 132 | APM 580 MBN | 150 |
| APM 3409 W | 132 | APM 4008 WH | 106 | APM 422 EOATMEAL | 132 | APM 580 T | 195 |
| APM 3409 WG | 132 | APM 402 BLACK OAK | 94 | APM 422 ERBK | 94 | APM 580 W | 196 |
| APM 3410 BKG | 96 | APM 402 CHARCOAL | 142 | APM 422 ERDW | 142 | APM 590 CHARCO | 95 |
| APM 3410 DWG | 186 | APM 402 CLEAR | 133 | APM 422 ERGY | 131 | APM 590 GOLD | 186 |
| APM 344 W | 132 | APM 402 MOCCA | 142 | APM 422 ESNOWGUM | 132 | APM 590 Platinum | 115 |
| APM 350-2 | 193 | APM 4020 NB | 140 | APM 422 EWH | 107 | APM 590 Silver | 115 |
| APM 350-4 | 193 | APM 4042 NB | 184 | APM 422 WH | 107 | APM 6006 AQUA | 142 |
| APM 350-5 BK | 193 | APM 4042 NB | 142 | APM 422-1 | 132 | APM 6006 BBL | 142 |
| APM 3505 MBN | 144 | APM 4043 CARBON | 94 | APM 422-2 | 132 | APM 6006 CYL | 142 |
| APM 3509 BKG | 97 | APM 4043 CASHEW | 132 | APM 422-3 | 132 | APM 6006 DBL | 142 |
| APM 3509 BKS | 97 | APM 4043 CHALK | 108 | APM 422-4 | 132 | APM 6006 FP | 143 |
| APM 3509 DW | 145 | APM 4043 CHARCOAL | 94 | APM 422-5 | 132 | APM 6006 MUST | 143 |
| APM 3509 DWG | 145 | APM 4043 COYOTE | 133 | APM 425 WG | 133 | APM 6006 PETALPINK | 143 |
| APM 3509 GO | 134 | APM 4043 WENGE | 142 | APM 4279 WH | 157 | APM 6006 RR | 143 |
| APM 3509 GOG | 134 | APM 4043 ZEBRANO | 133 | APM 47 AAN | 187 | APM 6006 TERRA | 143 |
| APM 3509 MT | 146 | APM 407 BLACK | 92 | APM 5 EMG | 185 | APM 604 EBK | 95 |
| APM 3509 NB | 145 | APM 407 CARB | 91 | APM 5 WG | 185 | APM 604 ECAMEL | 132 |
| APM 3509 W | 134 | APM 407 CASHEW | 131 | APM 506 DWBK | 145 | APM 604 ECASHEW | 132 |
| APM 3509 WG | 134 | APM 407 CHALK | 106 | APM 506 WBK | 146 | APM 604 RBK | 95 |
| APM 351 WH | 112 | APM 407 CHARC | 91 | APM 507 EBLACK | 104 | APM 604 RDW | 143 |
| APM 3511 RBL | 186 | APM 407 COYOT | 131 | APM 507 EPUREW | 112 | APM 608 BK | 95 |
| APM 3511 YL | 186 | APM 407 WENGE | 140 | APM 507 EWH | 197 | APM 608 DW | 143 |
| APM 3513 GOG | 187 | APM 407 ZEBRA | 131 | APM 518 CRG | 164 | APM 608 NB | 143 |
| APM 3609 BKG | 100 | APM 408 BK | 90 | APM 540 WHBR | 192 | APM 608 WH | 108 |
| APM 3609 BKS | 100 | APM 408 ECAMEL | 130 | APM 555 EGO | 189 | APM 609 BLACK | 98 |
| APM 3609 JG | 135 | APM 408 ECASHEW | 130 | APM 555 ENB | 189 | APM 609 DW | 146 |
| APM 3609 MT | 148 | APM 408 EOATMEAL | 130 | APM 56 AT | 187 | APM 609 NB | 146 |
| APM 37 GLBK | 122 | APM 408 ESNOWGUM | 130 | APM 56 W | 134 | APM 609 TALLOWOOD | 188 |
| APM 37 GLGR | 122 | | | APM 560 DW | 190 | APM 609 W | 133 |

| ORDER CODE | PG | ORDER CODE | PG | ORDER CODE | PG | ORDER CODE | PG |
|-------------------|-----|-------------------|-----|--------------------|-----|------------------|-----|
| APM 609 WH | 109 | APM 704-4 | 109 | APM 9 AGPK | 123 | CCF 403 MB | 99 |
| APM 610 BLACK | 100 | APM 706 EBK | 101 | APM 9 BMG | 144 | CCF 404 MB | 100 |
| APM 610 DW | 147 | APM 706 ECAMEL | 136 | APM 910 - 5 | 145 | CCF 406 MB | 103 |
| APM 610 NB | 148 | APM 706 ECASH | 136 | APM 910-2 | 188 | CCF 408 MB | 99 |
| APM 610 W | 135 | APM 706 EMULBERRY | 136 | APM 910-4 | 187 | CCF 408 WH | 110 |
| APM 611 EMULBERRY | 194 | APM 706 EOATMEAL | 136 | APM 92 AT | 194 | CCF 409 1YT | 139 |
| APM 611 EOATM | 137 | APM 706 ERGY | 136 | APM 92 ATG | 194 | CCF 409 1YT | 144 |
| APM 611 RBK | 103 | APM 706 ESNOWGUM | 136 | APM 92 CD | 193 | CCF 409 2MT | 139 |
| APM 611 RDW | 150 | APM 706 EWH | 110 | APM 92 GLOSS W | 111 | CCF 409 2MT | 144 |
| APM 611 RGY | 137 | APM 706 RBK | 101 | APM 92 WH | 111 | CCF 410 MB | 98 |
| APM 611 WH | 112 | APM 706 RDW | 149 | APM 920-1 | 136 | CG 200 - 2 | 198 |
| APM 616 FB | 196 | APM 711 BK | 90 | APM 920-2 | 136 | CG 200 - 3 | 198 |
| APM 619 WHBR | 107 | APM 711 NAVY | 140 | APM 920-4 | 192 | CG 201-2 | 169 |
| APM 620 WHBR | 109 | APM 711 RED | 140 | APM 920-5 | 191 | CG 201-3 | 169 |
| APM 625 WHBR | 111 | APM 711 WH | 106 | APM 944 GO | 197 | CG 201-4 | 169 |
| APM 630 BK | 100 | APM 715 NB | 194 | APM 989 BLK | 96 | CG 201-5 | 169 |
| APM 630 NB | 190 | APM 720 NB | 196 | APM 989 MOCCA | 143 | CG 202 - 1 | 170 |
| APM 670 NAWH | 187 | APM 770-7 SILV | 153 | APM 99 A/W | 190 | CG 202 - 2 | 170 |
| APM 670 RDWH | 187 | APM 770-8 BL | 153 | APM 99 WH | 110 | CG 202 - 3 | 170 |
| APM 68 AT | 189 | APM 79 BKGY | 91 | APM H100 CLEAR | 134 | CG 202 - 4 | 170 |
| APM 69 GO | 192 | APM 8 AG | 122 | APM T804 ECAMEL | 165 | CG 202 - 5 | 170 |
| APM 70 GO | 195 | APM 8 BK | 90 | APM T804 ECASHEW | 165 | CG 202 - 6 | 170 |
| APM 700 BK | 93 | APM 80 EWG | 136 | APM T804 EMULBERRY | 165 | CG 203-1 | 198 |
| APM 700 DW | 141 | APM 80 EWG | 193 | APM T804 EOATMEAL | 165 | CG 203-2 | 198 |
| APM 700 NB | 142 | APM 800 W | 187 | APM T804 ESNOWGUM | 165 | CG 203-3 | 198 |
| APM 700 WH | 107 | APM 83 BMG | 184 | APM T804 RBK | 165 | CG 203-4 | 198 |
| APM 701 BK | 98 | APM 845 NB | 145 | APM T804 RDW | 165 | CH 003 GOLD | 198 |
| APM 701 WH | 109 | APM 845 NBS | 145 | APM T804 RGY | 165 | CH 100 - 1 | 167 |
| APM 702 BK | 101 | APM 850 DW | 197 | APM/CM 1248 BK | 91 | CH 100 - 1 | 168 |
| APM 702 WH | 111 | APM 850 NB | 197 | APM/CM 1248 WH | 110 | CH 100 - 2 | 167 |
| APM 704 BK | 97 | APM 850 W | 197 | APM/CM 152 BK | 93 | CH 100 - 2 | 168 |
| APM 704 DW | 145 | APM 870 M | 143 | APM/CM 152 WH | 106 | CH 100 - 3 | 167 |
| APM 704 ECAMEL | 133 | APM 870 T | 132 | APM-CM 4008 BK | 90 | CH 100 - 3 | 168 |
| APM 704 ECASHEW | 133 | APM 870 TS | 185 | BC 208 GOLD | 187 | CH 100 - 4 | 167 |
| APM 704 EMULBERRY | 133 | APM 871 M | 146 | BC 209 Silver | 187 | CH 100 - 4 | 168 |
| APM 704 EOATMEAL | 133 | APM 871 MG | 146 | BC 2179 SILVER | 184 | CH 100 - 5 | 168 |
| APM 704 ESNOWGUM | 134 | APM 871 MS | 146 | BC 2348 GOLD | 188 | CH 100 - 6 | 168 |
| APM 704 NB | 145 | APM 871 T | 134 | BC 2401 GOLD | 184 | CH 100 - 7 | 168 |
| APM 704 RBK | 97 | APM 871 TG | 134 | BC 2402 SILVER | 184 | CH 1001 G | 174 |
| APM 704 RDW | 145 | APM 871 TS | 134 | CB 20 MB | 89 | CH 1001 S | 174 |
| APM 704 RGY | 133 | APM 873 M | 150 | CB 2040 MB | 89 | CH 101 - 1 | 167 |
| APM 704 W | 134 | APM 873 MG | 150 | CB 31 WH | 105 | CH 101 - 1 BLACK | 170 |
| APM 704 WH | 109 | APM 873 T | 137 | CB 31MB | 89 | CH 101 - 2 | 167 |
| APM 704-1 | 97 | APM 873 TG | 137 | CB 42 MB | 89 | CH 101 - 2 | 170 |
| APM 704-2 | 109 | APM 9 AGBN | 123 | CCF 402 MB | 89 | CH 101 - 3 | 167 |
| APM 704-3 | 97 | APM 9 AGGY | 123 | CCF 402 MB | 95 | CH 101 - 3 | 171 |

Index Moulding

| ORDER CODE | PG | ORDER CODE | PG | ORDER CODE | PG | ORDER CODE | PG |
|---------------------|-----|------------------------|-----|-------------------|-----|--------------------|-----|
| CH 102 - 1 | 169 | CH 2090 / 1 | 123 | CH 3312 - 2 | 169 | CH 6005-9 GB | 122 |
| CH 102 - 2 | 169 | CH 2120 G | 126 | CH 3336-1 | 202 | CH 6006/1 | 132 |
| CH 102 - 3 | 169 | CH 2146 BLACK | 169 | CH 3372 - 2 | 176 | CH 6006/10 SB | 113 |
| CH 103 - 4 MCS | 171 | CH 2146 WHITE | 170 | CH 3542 BK | 169 | CH 6006/10 SB | 115 |
| CH 103 - 6 BRLS | 171 | CH 2160 WHITE | 201 | CH 3542-2 BKS | 169 | CH 6006/11 SG | 121 |
| CH 103 BKS | 171 | CH 2180 | 198 | CH 3542-3 WH | 169 | CH 6006/11 SG | 123 |
| CH 103 BKG | 172 | CH 2220 - S | 169 | CH 3543 - 3 | 199 | CH 6006/12 SS | 113 |
| CH 104 - 4 | 172 | CH 2284-A | 198 | CH 366-3 | 176 | CH 6006/12 SS | 115 |
| CH 105 - 1 | 168 | CH 2291-7 | 175 | SILVER WITH BLACK | 176 | CH 6006/2 HONEY | 132 |
| CH 105 - 2 BLK | 168 | CH 2311-4 | 198 | CH 389-V 3211 | 200 | CH 6006/3 | 142 |
| CH 1080 BLACK | 168 | CH 2320 GOLD | 198 | CH 4001-176 | 172 | CH 6006/4 | 142 |
| CH 110 GOLD | 175 | CH 2323-4 | 171 | CH 401-S 214 | 200 | CH 6006/5 | 94 |
| CH 110 S-C | 173 | CH 2335 (SM)SILVER | 174 | CH 401-S 372 | 201 | CH 6006/6 | 142 |
| CH 110 SILVER | 201 | CH 2358 GOLD | 199 | CH 402 S 177 | 200 | CH 6006/9 GB | 121 |
| CH 110 SILVER SMALL | 200 | CH 2358 SILVER | 199 | CH 4235-1 | 167 | CH 6006/9 GB | 123 |
| CH 176 | 199 | CH 2366 - 1 | 168 | CH 4235-1 | 171 | CH 6007 - 1 | 135 |
| CH 2001/1 | 123 | CH 2405/3 GOLD | 173 | CH 4235-2 WH | 167 | CH 6007 - 2 | 135 |
| CH 2001/2 | 116 | CH 2405/4 SILVER | 200 | CH 4235-2 WH | 171 | CH 6007 / 3 | 148 |
| CH 2002/2 | 114 | CH 2422 SMALL SILVER | 175 | CH 445 - 1 | 171 | CH 6007 / 4 | 148 |
| CH 2005 / 1 | 125 | CH 2422 SMALL-6 | 202 | CH 462-5217 | 198 | CH 6007 / 7 | 111 |
| CH 2006/1 | 191 | CH 2422(LARGE) SILVER | 202 | CH 480 BG | 175 | CH 6007/10 SB | 113 |
| CH 2006/2 | 191 | CH 245 AC | 170 | CH 4900 G | 199 | CH 6007/10 SB | 119 |
| CH 2006/3 | 191 | CH 2456 - 5 | 171 | CH 4900 SILVER | 171 | CH 6007/11 SG | 121 |
| CH 2006/4 | 190 | CH 2456 - WH | 171 | CH 5001-6 | 175 | CH 6007/11 SG | 126 |
| CH 2015/1 | 191 | CH 247-A 189 | 198 | CH 5002-1 | 198 | CH 6007/12 SS | 113 |
| CH 2019 / 3 | 118 | CH 2587 (LARGE) SILVER | 176 | CH 5445 - 1 BK | 173 | CH 6007/12 SS | 119 |
| CH 2019 / 4 | 118 | CH 2587 (MEDIUM) GOLD | 174 | CH 5445 - 2 SILV | 173 | CH 6007/9 GB | 121 |
| CH 2035/1 | 184 | CH 2587 LGE TBN | 202 | CH 5445 - 3 WHITE | 173 | CH 6007/9 GB | 126 |
| CH 2041/1 | 190 | CH 2587 MED-S | 174 | CH 6000/1 | 186 | CH 6007-5 CHARCOAL | 191 |
| CH 2046 / 1 | 122 | CH 2587 SML-S | 172 | CH 6002/3 | 184 | CH 6008 - 2 | 135 |
| CH 2046/2 | 114 | CH 2587(LARGE) GOLD | 176 | CH 6003/2 | 144 | CH 6008/3 CHER | 147 |
| CH 2051/2 | 186 | CH 2587(SMALL) GOLD | 171 | CH 6003/4 | 144 | CH 6008/4 | 147 |
| CH 2072/1 | 152 | CH 2587(SMALL) GOLD | 199 | CH 6003-3 | 186 | CH 6008/6 | 147 |
| CH 2072/2 | 152 | CH 2628 - 1 | 174 | CH 6004/1 | 185 | CH 6008/7 | 110 |
| CH 2081 / 1 | 124 | CH 2628 - 2 | 174 | CH 6005/1 | 130 | CH 6008/8 BK | 99 |
| CH 2081/2 | 117 | CH 2628 - 3 | 174 | CH 6005/10 SB | 114 | CH 6009 / 6 | 148 |
| CH 2084 / 1 | 124 | CH 265 - A254 | 172 | CH 6005/11 SG | 121 | CH 6010/1 | 147 |
| CH 2084/2 | 116 | CH 265 BS | 172 | CH 6005/11 SG | 122 | CH 6010/3 | 147 |
| CH 2085 / 1 | 125 | CH 2669-3 | 176 | CH 6005/12 SS | 113 | CH 6010/4 | 147 |
| CH 2085 / 2 | 118 | CH 2676-3 | 171 | CH 6005/12 SS | 114 | CH 6010/6 | 147 |
| CH 2086/1 | 126 | CH 267-S126 | 174 | CH 6005/2 | 130 | CH 6012 - 3 | 140 |
| CH 2086/2 | 119 | CH 288-1 | 201 | CH 6005/3 | 140 | CH 6012 - 4 | 141 |
| CH 2087/2 | 187 | CH 288-2 | 201 | CH 6005/4 | 140 | CH 6012 - 5 | 91 |
| CH 2089/1 | 126 | CH 2999-4 SS | 115 | CH 6005/5 | 91 | CH 6012 - 6 | 141 |
| CH 2089/1 | 157 | CH 32 - 4 | 168 | CH 6005/6 | 140 | CH 6012 / 1 CLEA | 130 |
| | | | | CH 6005-9 GB | 121 | CH 6012 / 2 LIGH | 130 |

| ORDER CODE | PG |
|------------------------|-----|
| CH 6012/10 SB | 113 |
| CH 6012-10 SB | 114 |
| CH 6012-11 SG | 122 |
| CH 6012-11 SG | 121 |
| CH 6012-12 SS | 113 |
| CH 6012-12 SS | 114 |
| CH 6012-13 gloss black | 92 |
| CH 6012-14 (Gloss) | 107 |
| CH 6012-8 | 89 |
| CH 6012-9 GB | 121 |
| CH 6012-9 GB | 122 |
| CH 6013-1 | 130 |
| CH 6013-3 | 141 |
| CH 6013-4 | 141 |
| CH 6013-7 | 106 |
| CH 6013-8 | 93 |
| CH 6014-1 | 93 |
| CH 6014-1 | 129 |
| CH 6014-2 | 93 |
| CH 6014-2 | 129 |
| CH 6016/10 SB | 116 |
| CH 6016-1 | 133 |
| CH 6016-11 SG | 121 |
| CH 6016-11 SG | 124 |
| CH 6016-12 SS | 113 |
| CH 6016-12 SS | 116 |
| CH 6016-2 | 133 |
| CH 6016-3 | 144 |
| CH 6016-5 | 97 |
| CH 6016-6 | 144 |
| CH 6016-9 GB | 121 |
| CH 6016-9 GB | 124 |
| CH 6017 - 6 | 141 |
| CH 6017/1 | 107 |
| CH 6017/1 | 107 |
| CH 6017-2 PINK | 184 |
| CH 6017-4 GREEN | 184 |
| CH 6017-5 | 141 |
| CH 6018-2 CLEAR | 188 |
| CH 6018-3 RED | 188 |
| CH 6018-7 CHARCOAL | 188 |
| CH 6019-1 | 130 |
| CH 6019-2 | 130 |
| CH 6019-3 | 140 |
| CH 6019-4 | 140 |
| CH 6019-6 | 140 |

| ORDER CODE | PG |
|-------------------------|-----|
| CH 6019-7 | 106 |
| CH 6019-8 | 90 |
| CH 608-12 DARK MAHOGANY | 169 |
| CH 608 - 14WALNUT | 169 |
| CH 6100 BK | 199 |
| CH 6100 CHOCOLATE | 200 |
| CH 6100 G | 172 |
| CH 6501 | 198 |
| CH 6607 | 199 |
| CH 7 DB | 172 |
| CH 7 LB | 199 |
| CH 7000 - 3 | 114 |
| CH 7000 - 4 | 114 |
| CH 7000 - 5 | 114 |
| CH 7001 - 3 | 115 |
| CH 7001 - 5 | 115 |
| CH 7001-2 | 123 |
| CH 7001-4 | 115 |
| CH 7002 - 3 | 116 |
| CH 7002 - 4 | 117 |
| CH 7002 - 5 | 116 |
| CH 7003/5 | 114 |
| CH 7008 - 1 | 144 |
| CH 7008 - 4 | 117 |
| CH 7008-2 | 123 |
| CH 7702 | 200 |
| CH 8000 - 2 | 115 |
| CH 8001-1 | 122 |
| CH 8002-1 | 124 |
| CH 8002-2 | 117 |
| CH 8003 - 2 | 120 |
| CH 8003 - 3 | 127 |
| CH 8003 - 4 | 120 |
| CH 8004 - 1 | 127 |
| CH 8004 - 2 | 120 |
| CH 8005 - 2 | 116 |
| CH 8005-1 | 124 |
| CH 8007/1 | 196 |
| CH 8007/2 | 196 |
| CH 8008-1 | 102 |
| CH 8008-2 | 102 |
| CH 8008-4 | 102 |
| CH 8009-1 | 98 |
| CH 8009-2 | 98 |
| CH 8010-1 | 103 |
| CH 8010-2 | 103 |

| ORDER CODE | PG |
|-------------------------------|-----|
| CH 8011 - 2 | 118 |
| CH 8011-1 | 125 |
| CH 818 BLK | 171 |
| CH 818 BP | 171 |
| CH 818 WH | 171 |
| CH 820-1 BLACK | 202 |
| CH 820-2 SILVER | 202 |
| CH 9000 | 169 |
| CH 9004/2 | 201 |
| CH 9007 - 1 | 168 |
| CH 9100-1 | 152 |
| CH 9100-2 | 152 |
| CH 9100-3 | 152 |
| CH 9101-1 | 152 |
| CH 9101-2 | 152 |
| CH 9102-1 | 118 |
| CH 9102-2 | 148 |
| CH 9102-3 | 148 |
| CH 9103-2 | 124 |
| CH 9104-2 | 126 |
| CH 9105-2 | 119 |
| CH 9106-2 | 120 |
| CH 9107-1 | 122 |
| CH 9107-2 | 114 |
| CH 9108-2 BLACK With BROWN | 102 |
| CH 9108-3 BLACK With BROWN | 102 |
| CH 9109-1 | 152 |
| CH 9109-2 | 152 |
| CH 9109-3 | 152 |
| CH 9110-1 | 152 |
| CH 9110-2 | 152 |
| CH 9111-1 | 123 |
| CH 9111-2 | 115 |
| CH 9112-1 | 123 |
| CH 9112-2 | 116 |
| CH 9113-1 | 126 |
| CH 9113-2 | 119 |
| CH 9114-1 | 155 |
| CH 9114-2 | 155 |
| CH 9114-3 | 155 |
| CH 9114-4 (Gloss) | 155 |
| CH 9114-5 GLOSS WHITE | 155 |
| CH 9115-1 | 146 |
| CH 9116-1 | 153 |

| ORDER CODE | PG |
|--------------------|-----|
| CH 95 C SILVER | 199 |
| CH 97 G | 172 |
| CH 97 GOLD (L) | 173 |
| CH 97 S | 171 |
| CH 97 SILVER (L) | 173 |
| CH BLACK | 170 |
| CH BROWN | 170 |
| CHF 1001 - 1 | 165 |
| CHF 1001 - 2 | 165 |
| CHF 1001 - 3 | 165 |
| CHF 1001 - 5 | 165 |
| CHF 1001 - 6 | 165 |
| CHF 2 | 165 |
| CHF 2094-4 | 165 |
| CHF 2095 / 1 | 165 |
| CHF 2095 / 2 | 165 |
| CHF 2096 / 1 | 165 |
| CHF 2097 / 3 | 165 |
| CHF 2098 / 1 | 165 |
| CHF 2099 / 1 | 165 |
| CHF 3 | 165 |
| CHF 4 | 165 |
| CHF 466 21049 | 165 |
| CHF 466 5530 | 165 |
| CHF 466 SG 107 | 165 |
| CIS 013-1 BRONZE | 198 |
| CIS 155-1 BRONZE | 201 |
| CIS 246-1 BRONZE | 200 |
| CIS 246-2 GUNMETAL | 200 |
| CL 2789 BLACK | 93 |
| CL 2789 BROWN | 141 |
| CL 2789 CREAM | 107 |
| CL 2789 GRAY | 141 |
| CL 2789 WHITE | 107 |
| CL 4118 BLACK | 97 |
| CL 4118 BROWN | 145 |
| CL 4118 CREAM | 108 |
| CL 4118 GREY | 145 |
| CL 4118 WHITE | 108 |
| CL 600-1 | 130 |
| CL 600-2 | 140 |
| CL 600-3 | 140 |
| CL 600-5 | 106 |
| CL 601-1 | 140 |
| CL 601-2 | 106 |
| CL 601-3 | 91 |

Index Moulding

| ORDER CODE | PG | ORDER CODE | PG | ORDER CODE | PG | ORDER CODE | PG |
|---|-----|--------------------|-----|---------------------|-----|-----------------------|-----|
| CL 601-4 | 130 | CM 201 - 415 MBS | 98 | CM 387 DBR | 142 | CM 730 YT | 147 |
| CL 602-2 | 114 | CM 201/415 GLW | 109 | CM 387 DRED | 142 | CM 730 YT | 139 |
| CL 603 1 | 133 | CM 201/415 JS | 98 | CM 387 FRDBR | 139 | CM 740-1 MB | 94 |
| CL 603-2 | 143 | CM 201-415 DAKB | 124 | CM 387 FRDBR | 142 | CM 740-13 (GLOSS) | 94 |
| CL 603-3 | 95 | CM 201-415 DLAP | 116 | CM 387 SILVER | 115 | CM 740-14 GLOSS WHITE | 107 |
| CL 604-1 CHAMP | 122 | CM 2037 RAW | 179 | CM 4011 SF | 189 | CM 740-2 WH | 107 |
| CL 604-2 BRONZ | 122 | CM 2201 JS-Gloss | 92 | CM 4061 GF | 188 | CM 740-3 SILVER | 115 |
| CL 604-3 GUNMETAL | 114 | CM 2205W (Gloss) | 107 | CM 4092 GF | 189 | CM 750 MOCCA | 147 |
| CL 604-4 SILVER | 114 | CM 220WH | 163 | CM 410 MB | 94 | CM 750-1 MB | 99 |
| CL 6124 BLACK 66W x 30H x 14RH x 7.5RW | 102 | CM 221 WH | 108 | CM 4220 MB | 97 | CM 750-2 WH | 110 |
| CL 6124 BROWN | 149 | CM 221 WH | 164 | CM 5000 SL | 118 | CM 750-3 SILVE | 117 |
| CL 6124 CREAM | 111 | CM 2252 - 2 WHITE | 107 | CM 520 WH | 163 | CM 838 JS-Gloss | 92 |
| CL 6124 GREY | 149 | CM 2252-3 SILVER | 184 | CM 5237 BG | 96 | CM 838 MBG | 92 |
| CL 6124 WHITE | 111 | CM 2252-4 GUNMETAL | 184 | CM 5237 BG | 129 | CM 838 MBS | 92 |
| CM 020-282-001 GOLD | 184 | CM 2252-5 FRDBR | 184 | CM 5237 BS | 96 | CM 838 YT | 141 |
| CM 033 - 167 MB | 92 | CM 23601 M | 93 | CM 5237 BS | 129 | CM 839 MT | 141 |
| CM 033-167 WH | 105 | CM 270 MB | 163 | CM 5248 BG | 99 | CM 870 MBG | 96 |
| CM 033-167 WH | 107 | CM 270 MOCCA | 163 | CM 5248 BG | 129 | CM 870 MBS | 96 |
| CM 055 MB | 92 | CM 270 RAW | 163 | CM 5248 BS | 99 | CM 912 JS (GLOSS) | 90 |
| CM 1" 1/4 LINEN | 163 | CM 270 WHITE | 163 | CM 5248 BS | 129 | CM 912 MBG | 90 |
| CM 1" LINEN | 163 | CM 280-1 | 162 | CM 5528-321 | 90 | CM 923 GL | 140 |
| CM 1000 MB | 92 | CM 280-2 | 162 | CM 5528-571 (GLOSS) | 90 | CM 960 MBG | 97 |
| CM 1075 JS GLOSS | 92 | CM 290 BK | 162 | CM 5998-1 MB | 91 | CM 960 MBS | 187 |
| CM 1075 MBG | 92 | CM 290 RAWM | 162 | CM 6007 / 6 | 148 | CP 300 - 1BK | 167 |
| CM 110 M | 90 | CM 290 WHITE | 161 | CM 6007 / 7 | 105 | CP 300 - 1BK | 168 |
| CM 1211 | 152 | CM 293 MT | 140 | CM 605-1 | 125 | CP 300 - 2WH Cream | 198 |
| CM 124 G | 126 | CM 293 YT | 140 | CM 605-2 | 118 | CP 300 - 4 PUREW | 168 |
| CM 1240 G | 123 | CM 2945 WH | 107 | CM 624 MB | 101 | CP 300 - 5 | 167 |
| CM 1241 S | 116 | CM 2999-1 BG | 186 | CM 640-1 MB | 100 | CP 300 - 5 | 168 |
| CM 1502- Gloss | 184 | CM 3000 - 4 SS | 116 | CM 640-4 SBK | 118 | CP 306 - 1 SILVER | 175 |
| CM 154 B-Gloss | 92 | CM 3000-1 BG | 188 | CM 650-1 MB | 154 | CP 307-1 BG | 176 |
| CM 154 M | 92 | CM 3001-1 BG | 126 | CM 716 JS (GLOSS) | 93 | CP 307-2 BS | 176 |
| CM 184 W (Gloss) | 108 | CM 3001-2 BS | 195 | CM 716 M | 89 | CP 308-1 | 166 |
| CM 185 B(Gloss) | 96 | CM 3001-3SG | 126 | CM 716 M | 93 | CP 308-2 | 166 |
| CM 185 BKS (Gloss) | 96 | CM 3001-4 SS | 119 | CM 716 WH | 107 | CP 310 - 1 | 176 |
| CM 185 BNGL (Gloss) | 96 | CM 300-2 | 115 | CM 720 MBG | 129 | CP 311 - 4 | 201 |
| CM 185 M | 96 | CM 312 M | 90 | CM 720 MBGL | 94 | CP 5720 SILVER | 173 |
| CM 195 MB | 96 | CM 312-JS (GLOSS) | 90 | CM 720 MT | 139 | CPF 1001-10 | 166 |
| CM 2001 JS (Gloss) | 99 | CM 320-1 BKG | 90 | CM 720 MT | 142 | CPF 1001-7 | 166 |
| CM 2001 MB | 98 | CM 320-2 BKS | 90 | CM 720 YT | 139 | CPF 1001-8 | 166 |
| CM 2005 W (Gloss) | 110 | CM 369 FRDBR | 144 | CM 720 YT | 142 | CPF 1002-1 | 166 |
| CM 2005 WH | 105 | CM 369 FRDBR | 139 | CM 722 MB | 185 | CPF 1002-2 | 166 |
| CM 2005 WH | 110 | CM 370 FRDBR | 148 | CM 730 MBGL | 99 | CPF 1002-3 | 166 |
| CM 201 - 410 MB | 95 | CM 370 FRDBR | 139 | CM 730 MBGL | 129 | CPF 1002-4 | 166 |
| CM 201 - 415 DAAY | 116 | CM 370 MB | 89 | CM 730 MT | 147 | CPF 1002-5 | 166 |
| | | CM 370 MB | 102 | CM 730 MT | 139 | CPF 1002-8 | 166 |

| ORDER CODE | PG | ORDER CODE | PG | ORDER CODE | PG | ORDER CODE | PG |
|-----------------|-----|----------------|-----|---------------|-----|----------------|-----|
| CPF 1003 - 1 | 166 | CW 305 BKSI | 160 | DC 1930-2 | 103 | DC 868-1 WH | 112 |
| CPF 1003 - 2 | 166 | CW 305-1 | 151 | DC 2026-1 | 96 | DC 868-2 BK | 102 |
| CPF 1003 - 3 | 166 | CW 305-2 | 151 | DC 2026-2 | 96 | DC 868-4 NB | 150 |
| CPF 1004 - 1 | 166 | CW 308-1 | 151 | DC 2027-2 | 100 | DC BLACK/GOLD | 167 |
| CPF 1004 - 2 | 166 | CW 308-2 | 151 | DC 2137-1 | 154 | DC BLACK/GOLD | 170 |
| CPF 1005 - 1 | 166 | CW 305 WH | 159 | DC 2137-2 | 154 | DC BLACK/SILVE | 167 |
| CPF 1005 - 2 | 166 | CZ 2237 | 153 | DC 2229-1 | 157 | DC BLACK/SILVE | 170 |
| CPF 1006 - 1 | 166 | CZ 2540 - 0164 | 124 | DC 2229-2 | 157 | DC BLK/GOLD LG | 172 |
| CPF 1006 - 2 | 166 | CZ 2552 - 2164 | 154 | DC 2337 - 3 | 95 | DC BLK/SIL LG | 172 |
| CPF 1006 - 3 | 166 | CZ 2654 - 2164 | 154 | DC 2337 - 4 | 95 | DC MAHO | 167 |
| CPF 1007 - 1 | 166 | CZ 3155-2114 | 190 | DC 2337-1 | 108 | DC MAHO | 170 |
| CPF 1007 - 2 | 166 | CZ 3164 - 2164 | 156 | DC 2338-1 | 109 | DC MAHOG LG | 172 |
| CPF 1007 - 3 | 166 | CZ 3164 - 3111 | 156 | DC 2338-3 | 97 | DC WALNUT | 167 |
| CPF 1008 - 1 | 166 | CZ 3459-3022 | 155 | DC 2405-1 | 114 | DC WALNUT | 170 |
| CPF 1008 - 2 | 166 | CZ 3541 - 2001 | 153 | DC 2405-3 | 122 | DC WALNUT LG | 172 |
| CPS 8001-1 | 198 | CZ 3587-4001 | 159 | DC 327 MBSF | 124 | DP 100 GOLD | 202 |
| CPS 801-1 | 168 | CZ 3759 - 2001 | 155 | DC 327 MBWX | 99 | DP 100 S SML | 169 |
| CS 202-1 | 190 | CZ 3759-3023 | 155 | DC 327 MYEF | 124 | DP 100 SILVER | 176 |
| CS 207 - 2 | 156 | CZ 4078-2114 | 157 | DC 3760-1 | 91 | DRM BLUE | 170 |
| CS 207- 2 | 151 | CZ 4078-2164 | 157 | DC 3760-2 | 91 | DRM WALNUT | 170 |
| CS 208 - 1 | 125 | CZ 4164 - 2114 | 156 | DC 3760-3 | 92 | EMA 1 | 163 |
| CS 209 - 1 | 152 | CZ 4177-0062 | 195 | DC 3762-1 | 96 | EMA 2 | 166 |
| CS 209 -1 | 151 | CZ 4279-5112 | 157 | DC 3762-2 | 96 | FH3 N-NG | 175 |
| CU 3 - NEG | 173 | CZ 5075 - 2115 | 157 | DC 3762-3 | 96 | FH3-NES | 175 |
| CU 3 - NES | 173 | CZ 5591 - 2111 | 159 | DC 412-4 W | 147 | FM3 NES | 202 |
| CU 4100-1 | 162 | DC 1305 - 1 | 146 | DC 413 - 4 W | 149 | GG 31 - 1 | 144 |
| CU 4100-2 | 162 | DC 1305 - 2 | 146 | DC 413-1 TEAK | 149 | GG 31 - 2 | 144 |
| CU 4100-3 | 162 | DC 1305 - 3 | 146 | DC 413-2 DW | 149 | GG 31 - 3 | 144 |
| CU 4100-4 | 162 | DC 1305 - 4 | 146 | DC 413-3 NT | 149 | GG 4134 - 1 | 145 |
| CU 4100-5 | 162 | DC 1305 - 5 | 146 | DC 4642-1 | 123 | GG 4134 - 2 | 145 |
| CU 4100-6 | 162 | DC 1305-6 GOLD | 124 | DC 4642-2 | 96 | GG 4134 - 3 | 145 |
| CU 4101-1 | 122 | DC 1305-7 | 117 | DC 4642-3 | 115 | GL 2020 MBT | 89 |
| CU 4101-2 | 152 | DC 1306 - 1 | 149 | DC 4642-4 | 115 | GL 2020 WHT | 105 |
| CU 4102-1 | 153 | DC 1306 - 2 | 150 | DC 513 GL | 185 | GL 2040 MBT | 93 |
| CU 4102-2 | 154 | DC 1306 - 3 | 150 | DC 513 MBK | 95 | GL 2040 WHT | 105 |
| CU 4103-1 | 124 | DC 1306 - 4 | 150 | DC 531 BKSL | 118 | GL 3120 MBT | 89 |
| CU 4103-2 | 117 | DC 1306 - 5 | 150 | DC 799 WYES | 126 | GL 3120 WHT | 105 |
| CU 4104-2 | 114 | DC 1310 - 1 | 141 | DC 800 WYES | 127 | GL 4220 MBT | 89 |
| CU 4105-2 | 115 | DC 1310 - 2 | 141 | DC 8000-1 | 123 | GL 4220 WHT | 105 |
| CU 4106-2 | 117 | DC 1485-1 | 123 | DC 815 SLBK | 98 | GL 4235 MBT | 89 |
| CU 4107-2 | 119 | DC 1485-2 | 114 | DC 816 GLBK | 103 | GL 4235 WHT | 105 |
| CU 42 CLEAR | 133 | DC 1485-3 | 115 | DC 816 SLBK | 103 | GL 6020 MBT | 100 |
| CW 300-3 NB | 186 | DC 1486-1 | 124 | DC 867-1 WH | 109 | GL 6020 WHT | 105 |
| CW 302 - 1 GOLD | 159 | DC 1486-2 | 117 | DC 867-2 BK | 98 | IT 1100-1050 | 115 |
| CW 303-1 GOLD | 160 | DC 1486-3 | 117 | DC 867-3 TEAK | 146 | IT 1152-1000 | 119 |
| CW 303-2 SILVER | 160 | DC 1930-1 | 103 | DC 867-4 NB | 146 | IT 1152-1050 | 119 |

Index Moulding

| ORDER CODE | PG | ORDER CODE | PG | ORDER CODE | PG | ORDER CODE | PG |
|-------------------|-----|-----------------|-----|-------------------|-----|----------------------|-----|
| IT 2317 GRIGIO | 131 | MG 20 MB | 89 | OP 2845 BK | 94 | PF 6 SHINY SILVER | 178 |
| IT 2317 NATURA | 131 | MG 20 MB | 91 | OP 2845 BK | 94 | PF 6 WHITE | 178 |
| IT 2317 NOCE | 131 | MG 20 WH | 107 | OP 2845 RAW | 179 | PF 7 BRUNSWICK GREEN | 178 |
| IT 2318 GRIGIO | 135 | MG 2040 MB | 91 | OP 2845 WH | 107 | PF 7 GOLDM | 178 |
| IT 2318 NATURA | 135 | MG 2040 WH | 105 | OP 3017 BK | 94 | PF 7 MATT BLACK | 178 |
| IT 2318 NOCE | 135 | MG 2040 WH | 107 | OP 3017 ESP | 142 | PF 7 MATT SILVER | 178 |
| IT-1811 ANTRAC | 152 | MG 31 MB | 89 | OP 3017 WH | 107 | PF 7 PEWT | 178 |
| IT-1811 BIANCO | 152 | MG 31 MB | 94 | OP 3020 RAW | 179 | PF 7 RED | 178 |
| IT-1811 GRIGIO | 152 | MG 31 WH | 105 | OP 3125 BK | 95 | PF 7 SHINY BLACK | 178 |
| IT-1811 NATURA | 152 | MG 31 WH | 108 | OP 3125 ESP | 142 | PF 7 SHINY BRONZE | 178 |
| IT-1811 NOCE | 152 | MG 3126 MB | 89 | OP 3125 WH | 108 | PF 7 SHINY GOLD | 178 |
| IT-1812 BIANCO | 154 | MG 3126 MB | 95 | OP 4020 BK | 97 | PF 7 SILBR | 178 |
| IT-1812 GRIGIO | 154 | MG 3126 WH | 105 | OP 4020 WH | 108 | PF 7 WEDGE | 178 |
| IT-1812 NATURA | 154 | MG 3126 WH | 108 | OP 6028 BK | 163 | PF 7 WHI | 178 |
| IT-1812 NOCE | 154 | MG 4134 MB | 89 | OP 6028 ESP | 163 | PF16 BRONZE | 179 |
| IT215 BIANCO | 131 | MG 4134 MB | 98 | OP 6028 RAW | 163 | PF16 CHAMPAGNE | 179 |
| IT215 GRIGIO | 131 | MG 4134 WH | 105 | OP 6028 RAW | 179 | PF16 GOLD | 179 |
| IT215 NATURALE | 131 | MG 4134 WH | 109 | OP 6028 WH | 164 | PF16 PEWTER | 179 |
| IT-215 NERO | 93 | MG 42 MB | 89 | OP 6029 BK | 163 | PF16 SILV | 179 |
| IT215 NOCE | 131 | MG 42 MB | 97 | OP 6029 ESP | 164 | PF16 SILV BR | 179 |
| IT216 BIANCO | 133 | MG 42 WH | 105 | OP 6029 RAW | 163 | PF16 SILVM | 179 |
| IT216 GRIGIO | 133 | MG 42 WH | 108 | OP 6029 RAW | 179 | RAM 75 | 177 |
| IT216 NATURAL | 133 | MG 65 MB | 89 | OP 6029 WH | 164 | RAW 1 BWOOD | 181 |
| IT-216 NERO | 96 | MG 65 MB | 102 | OP 6247 BK | 101 | RAW 1 OAK | 180 |
| IT216 NOCE | 133 | MG 65 WH | 105 | OP 6247 ESP | 148 | RAW 1 OAK | 181 |
| IT-2317 BIANCO | 107 | MG 65 WH | 111 | OP 6247 WH | 110 | RAW 150 OAK | 180 |
| IT-2317 NERO | 92 | OP 11023 BK | 104 | OP1222-1 BK | 90 | RAW 152 OAK | 180 |
| IT-2318 BIANCO | 110 | OP 11023 ESP | 150 | OP1320 BK | 90 | RAW 152 OAK | 182 |
| IT-2318 NERO | 99 | OP 11023 WH | 112 | OP1938ESP | 140 | RAW 1S OAK BK | 181 |
| IT-6016-1730 | 108 | OP 1222-2 WH | 106 | OP2213 3GREY | 131 | RAW 1S OAK BRO | 181 |
| IT-6016-1730 | 144 | OP 1320 ESP | 140 | OP2213 4WAL | 131 | RAW 1S OAK WH | 181 |
| IT-6016-1760 | 143 | OP 1320 RAW | 179 | OP2213-1 BK | 92 | RAW 2 OAK | 161 |
| IT-9221 ANTRACITE | 92 | OP 1320 WH | 106 | OP4020RAW | 181 | RAW 2 OAK | 180 |
| IT-9221 ARGENTO | 114 | OP 1927 RAW | 179 | OP408-35RAW | 179 | RAW 2 OAK | 182 |
| IT-9221 BRONZO | 122 | OP 1938 BK | 92 | PF 3 MATT BLACK | 178 | RAW 2 OAK BK | 161 |
| IT-9221 CHAMPAYNE | 114 | OP 1938 CRE | 106 | PF 3 MATT SILVER | 178 | RAW 2 OAK BK | 182 |
| IT-9221 ORO | 122 | OP 1938 RAW | 179 | PF 4 MATT BLACK | 178 | RAW 2 OAK BRONZE | 161 |
| IT-9221 PERTRO | 114 | OP 1938 WH | 106 | PF 4 MATT SILVER | 178 | RAW 2 OAK BRONZE | 182 |
| IT-9222 ANTACITE | 99 | OP 2020 BK | 91 | PF 5 MATT BLACK | 178 | RAW 2 OAK WH | 161 |
| IT-9222 ARGENTO | 118 | OP 2020 RAW | 179 | PF 6 MATT BLACK | 178 | RAW 2 OAK WH | 182 |
| IT-9222 BRONZO | 125 | OP 2020 RAW | 179 | PF 6 MATT GOLD | 178 | RAW 2060 OAK | 180 |
| IT-9222 CHAMPAYNE | 118 | OP 2020 WH | 106 | PF 6 MATT SILVER | 178 | RAW 2060 OAK | 182 |
| IT-9222 ORO | 125 | OP 2060 RAW | 179 | PF 6 SHINY BLACK | 178 | RAW 2060 OAK BLK | 182 |
| IT-9222 PERTRO | 118 | OP 2060 WH | 106 | PF 6 SHINY BRONZE | 178 | RAW 2060 OAK BR | 182 |
| LAM 63MM | 177 | OP 2213 - 5 ESP | 141 | PF 6 SHINY GOLD | 178 | RAW 2060 OAK WH | 182 |
| LAM 67X33 | 177 | OP 2213-2WH | 107 | PF 6 SHINY PEWTER | 178 | RAW 23 OAK | 180 |

| ORDER CODE | PG |
|-----------------------|-----|
| RAW 24 BLACK | 91 |
| RAW 24 OAK | 179 |
| RAW 3 OAK | 181 |
| RAW 30 X 30 STRET | 177 |
| RAW 30MM STRET | 177 |
| RAW 32 X 38 | 177 |
| RAW 4 STR BAR | 175 |
| RAW 40 X 40 STRET | 177 |
| RAW 402 OAK | 180 |
| RAW 402 OAK | 181 |
| RAW 4030 OAK | 180 |
| RAW 4030 OAK | 181 |
| RAW 4030OAK AQ | 181 |
| RAW 4030OAK BK | 181 |
| RAW 4030OAK LI | 181 |
| RAW 4030OAK OR | 181 |
| RAW 4030OAK RED | 181 |
| RAW 4030OAK WH | 181 |
| RAW 4030OAK YE | 181 |
| RAW 4042 OAK | 180 |
| RAW 4042 OAK | 182 |
| RAW 4043 OAK | 182 |
| RAW 4043 OAK BK | 94 |
| RAW 4043 OAK WH | 108 |
| RAW 407 OAK | 180 |
| RAW 407 OAK | 181 |
| RAW 408-35 OAK | 180 |
| RAW 408-35 OAK | 182 |
| RAW 40MM STRET | 177 |
| RAW 4113 OAK | 180 |
| RAW 4113 OAK | 181 |
| RAW 506 OAK | 182 |
| RAW 6 OAK | 180 |
| RAW 604 OAK | 180 |
| RAW 63 VERTICA | 177 |
| RAW 63MM STRET | 177 |
| RAW 67 X 29 STRETCHER | 177 |
| RAW 67 X 33 | 177 |
| RAW 706 OAK | 182 |
| RAW 711 OAK | 180 |
| RAW REV 3238 | 175 |
| RAW S12X6 OAK | 181 |
| RAW S20X6 OAK | 181 |
| RAW S20X8 OAK | 181 |
| SC 500-1 | 122 |
| SC 500-2 | 114 |

| ORDER CODE | PG |
|-------------------|-----|
| SC 500-3 | 122 |
| SC 501-1 | 123 |
| SC 501-2 | 116 |
| SC 501-3 | 123 |
| SC 5017 | 130 |
| SC 502-1 | 125 |
| SC 502-2 | 117 |
| SC 502-3 | 125 |
| SC 5026 | 130 |
| SC 5027 | 130 |
| SC 503-1 | 115 |
| SC 504-1 | 144 |
| SC 504-2 | 144 |
| SC 504-3 | 144 |
| SC 505-1 | 114 |
| SC 505-1 | 122 |
| SC 505-3 | 114 |
| SC 506-1 | 144 |
| SC 507-1 | 147 |
| SC 507-2 | 147 |
| SC 508-1 | 145 |
| SC 508-2 | 145 |
| SC 7818 W | 137 |
| SF 608 SILVER | 169 |
| SF 646-174 SILVER | 173 |
| SF 647-176 | 172 |
| SF 647-176 | 199 |
| SF 648 | 199 |
| SF 662-176 | 201 |
| SF 665 | 173 |
| SF 665-180 | 200 |
| TKY-BLK | 168 |
| VC 400-1 BK | 158 |
| VC 400-2 WH | 158 |
| VC 400-3 GOLD | 158 |
| VC 400-4 SIL | 159 |
| VC 401-1GOLD | 155 |
| VC 401-2 SILVER | 155 |
| VC 402-1 BK | 156 |
| VC 402-2 WH | 156 |
| VC 402-3 WV | 156 |
| VC 402-4 | 156 |
| VC 403-1 | 153 |
| VC 403-2 | 153 |
| VC 403-3 | 153 |
| VC 403-4 | 153 |

| ORDER CODE | PG |
|----------------|-----|
| VC 404-1 | 100 |
| VC 404-2 | 100 |
| VC 405 - 1 | 95 |
| VC 406-1 | 101 |
| WV1 ARSENIC | 83 |
| WV1 BUTTERNUT | 83 |
| WV1 CHESTNUT | 83 |
| WV1 IRONBARK | 83 |
| WV1 MERABAU | 83 |
| WV1 OYSTER | 83 |
| WV1 PURE WHITE | 83 |
| WV1 SMOKE | 83 |
| WV1 STORM | 83 |
| WV1 STRAW | 83 |
| WV1 WHITEOAK | 83 |
| WV2 ARSENIC | 83 |
| WV2 BUTTERNUT | 83 |
| WV2 CHESTNUT | 84 |
| WV2 IRONBARK | 83 |
| WV2 MERABAU | 84 |
| WV2 OYSTER | 84 |
| WV2 PURE WHITE | 84 |
| WV2 SMOKE | 84 |
| WV2 STORM | 84 |
| WV2 STRAW | 84 |
| WV2 WHITEOAK | 84 |
| WV3 ARSENIC | 84 |
| WV3 BUTTERNUT | 84 |
| WV3 CHESTNUT | 85 |
| WV3 IRONBARK | 84 |
| WV3 MERABAU | 84 |
| WV3 OYSTER | 84 |
| WV3 PURE WHITE | 84 |
| WV3 SMOKE | 84 |
| WV3 STORM | 84 |
| WV3 STRAW | 85 |
| WV3 WHITEOAK | 85 |
| WV4 ARSENIC | 85 |
| WV4 BUTTERNUT | 85 |
| WV4 CHESTNUT | 85 |
| WV4 IRONBARK | 85 |
| WV4 MERABAU | 85 |
| WV4 OYSTER | 85 |
| WV4 PURE WHITE | 85 |
| WV4 SMOKE | 85 |
| WV4 STORM | 85 |

| ORDER CODE | PG |
|----------------|----|
| WV4 STRAW | 85 |
| WV4 WHITEOAK | 85 |
| WV5 ARSENIC | 86 |
| WV5 BUTTERNUT | 86 |
| WV5 CHESTNUT | 86 |
| WV5 IRONBARK | 86 |
| WV5 MERABAU | 86 |
| WV5 OYSTER | 86 |
| WV5 PURE WHITE | 86 |
| WV5 SMOKE | 86 |
| WV5 STORM | 86 |
| WV5 STRAW | 86 |
| WV5 WHITEOAK | 86 |
| WV6 ARSENIC | 87 |
| WV6 BUTTERNUT | 87 |
| WV6 CHESTNUT | 87 |
| WV6 IRONBARK | 87 |
| WV6 MERABAU | 87 |
| WV6 OYSTER | 87 |
| WV6 PURE WHITE | 87 |
| WV6 SMOKE | 87 |
| WV6 STORM | 87 |
| WV6 STRAW | 87 |
| WV6 WHITEOAK | 87 |
| WV7 ARSENIC | 88 |
| WV7 BUTTERNUT | 88 |
| WV7 CHESTNUT | 88 |
| WV7 IRONBARK | 88 |
| WV7 MERABAU | 88 |
| WV7 OYSTER | 88 |
| WV7 PURE WHITE | 88 |
| WV7 SMOKE | 88 |
| WV7 STORM | 88 |
| WV7 WHITEOAK | 88 |

Index Machinery Matboard & Accessories

| ORDER CODE | PG | ORDER CODE | PG | ORDER CODE | PG | ORDER CODE | PG |
|--------------------------------|-------|----------------------------------|-------|---------------------------------------|-------|--------------------------------------|-------|
| 3m 700 Cleaner Spray | 14 | Cassese Spares | 29 | Fletcher Multi Master Gun (Yellow) | 29 | Frametek Frame Spacer | 21 |
| 3m Glass Cleaner 500 Spray | 14 | Cassese Vnails | 30 | Fletcher Multi Master Points (Yellow) | 30 | Front Runner black | 10 |
| 3M Magic Tape | 19 | Cellophane | 12 | Fletcher Oval Cutter | 25 | Gallery Hanging Slim Line | 8 |
| 3m Photo Mount Spray | 14 | Cleaning Cloths | 13 | Fletcher Plastic Cutting | 26 | Gallery Hanging System | 8 |
| 3m Repositionable Spray | 14 | Clips, Standback | 10 | Fletcher Pliers | 25 | Gallery Lighting System | 8 |
| 3m Super 77 Multipurpose Spray | 14 | Colourmount matboard | 40-44 | Fletcher Pneumatic Gun | 30 | Gallery Stretching Machine | 69 |
| 3M Tapes | 19 | Conservation matboard , DUO | 39 | Fletcher Pull Mate | 25 | Gaskets | 24 |
| Adhesive Sprays | 14 | Conservation matboard , Rising | 39 | Fletcher Score Master | 25 | Genesis Flexi Points | 30 |
| Adjustable Hangers | 5 | Cord | 3 | Fletcher Spring Mate | 25 | Genesis Matboard | 47 |
| Airco Staple Guns | 31 | Cord, Australian | 3 | Fletcher, Mattcutting wheels | 27 | Genesis Pneumatic Flexi Point Driver | 30 |
| Airco Staples | 3 | Cord, Miracle | 3 | Flexi Gun, Fletcher (Green) | 29 | Genesis Vnails | 30 |
| Aluminium Hardware | 31 | Corner Protectors | 12 | Flexi Gun, Fletcher (Yellow) | 29 | Gilders Paste | 21 |
| Amaco nail filler | 21 | Crimping Gun | 4 | Flexi gun, Omer | 29 | Gilman Foamboard | 50 |
| Apro Cut | 59 | Crimping Pliers | 4 | Flexi Gun, Pneumatic Omer | 29 | Glass | 34-36 |
| Apron | 13 | Crimping Sleeves | 4 | Flexi Gun, Pneumatic Taurus | 29 | Glass & Laminate Cleaners, 3M | 14 |
| Artglass | 34,35 | Curl up & Stand | 11 | Flexi Point Driver, Genesis | 30 | Glass & Plastic Cleaner | 14 |
| ATG Adapter | 20 | Designer Matboard | 49 | Flexi Point Driver, Pneumatic | 30 | Glass cutter, TOYO | 24 |
| ATG Pick up | 20 | Display Boxes acrylic | 9 | Flexi Points, Framers Corner | 30 | Glass Cutters | 24 |
| ATG Tapes | 20 | Double Mitre Saws | 58 | Flexi Points, Genesis | 30 | Glass cutting Wheel, Fletcher | 27 |
| Avery fabric tools | 11 | Double Mitre Saws, Brevetti | 54-58 | Flexi Points, Logan | 29 | Glass File | 25 |
| Backing Tape, Black | 15 | Drings | 4,5,6 | Flexible Points, Cassese | 30 | Glass Speed Cutter | 25 |
| Backing Tape, Brown | 15 | Duct tape | 16 | Flexible Points, Fletcher (Green) | 30 | Glass, artglass | 34&35 |
| Backing Tape, White | 15 | Duo Board | 39 | Foam sponge overlay | 53 | Glass, Preservation | 34 |
| Barrier Paper | 53 | Dust Collector | 60 | Foamboard | 50-52 | Glaziers points, Fletcher | 30 |
| Bevelled Mirrors | 36 | Easel & Hinges | 10 | Foamboard Adhesive Black | 52 | Gloss Spray, Mirotone | 22 |
| Black Flexi Points, Cassese | 30 | Edgingtape | 19 | Foamboard Adhesive White | 52 | Gloves, Antistatic | 13 |
| Blade Dispenser | 28 | Epson printing papers | 81 | Foamboard Black | 52 | Gloves, Cotton | 13 |
| Blades & Knives | 28 | Erasers | 13 | Foamboard Conservaiton Gilman | 5 | Gloves, Glass | 13 |
| Blades , Wizard | 27 | Eurohangers | 23 | Foamboard Hangers | 6 | Glue | 20 |
| Blades, Brevetti | 27 | EVA Glue | 20 | Foamboard Heat Activated Gilman | 51 | Glue , Black Magic PVA | 20 |
| Bostick Glue | 19 | Excalibur, Keencut | 65 | Foamboard Insite Reveal Gilman | 50 | Glue for Hot/ Cold Machine | 20 |
| Bracing corner | 5 | Ezy Bars | 7 | Foamboard Repositionable | 52 | Glue, Bostick | 19 |
| Brackets | 7 | Fillet Tape | 19 | Foamboard Ryno Board | 50 | Glue, EVA | 20 |
| Brevetti, Joiners | 61-63 | Filmoplast | 16 | Foamboard White | 52 | Glue, PVA | 20 |
| Brevetti, Pneumatic Vnail Gun | 30 | Fletcher Bearing | 27 | Fragile packaging tape | 11 | Glue, Synthetic | 20 |
| BrushTex | 15 | Fletcher Flexi Gun (Green) | 29 | Frame Spacers, Frametek | 21 | Gluing Machine | 78-79 |
| Bubble Wrap | 12 | Fletcher Flexible Points (Green) | 30 | Framers Gun (Black) | 29 | Guillotine Blades | 28 |
| Bumpers Felt and Foam | 4 | Fletcher Framers Gun (Black) | 29 | Framers Points, Fletcher (Black) | 29 | Guillotine Blades, Jyden | 28 |
| Canon printing papers | 81 | Fletcher Framers Points (Black) | 30 | Fletcher Glaziers Points | 30 | Guillotine Blades, Morso | 28 |
| Canvas Offsets | 24 | Fletcher Machinery Accessories | 26 | Fletcher Spring Mate | 25 | Guillotines | 59 |
| Canvas Pliers | 26 | | | Framers Points, Fletcher (Black) | 29 | Gun, Fletcher Pneumatic | 30 |
| Canvas Stretching Machine | 69 | | | Framers Tape II | 16 | Gun, Vnail Pneumatic Brevetti | 30 |
| Carpet | 10 | | | | | Hair Clip Hangers | 23 |
| Cassese Black Flexi | 30 | | | | | | |

| ORDER CODE | PG |
|---------------------------------|-------|
| Hangers, Foamboard | 6 |
| Hangers, Sawtooth | 5 |
| Hangers, Wood | 4,5 |
| Hanging System | 8 |
| Hardware Aluminium | 23 |
| Hinges | 10 |
| Hinges & Easels | 10 |
| Hinging Tape | 16 |
| JAC Paper | 19 |
| Jyden Guillotine Blades | 28 |
| Keencut Excalibur | 65 |
| Keencut Safety Straight Edge | 29 |
| Keencut Ultimat Gold | 66 |
| Kikusui Tapes | 15,16 |
| Kneaded Rubber | 13 |
| Kraft Paper | 11 |
| Kraft Paper Black | 11 |
| Kraft Paper Dispenser | 11 |
| Laminate & Glass Cleaners, 3M | 14 |
| Laminaters | 76 |
| Lamination, prints | 75 |
| Lineco Burnishing Bone | 15 |
| Lineco tapes | 17,18 |
| Loader Cartridges | 31 |
| Logan Dual Point Driver | 29 |
| Logan Flexi Points | 29 |
| Logan Glass cutter | 24 |
| Logan Mat cutter | 25 |
| Logan Rigid Points | 29 |
| Machine, Cold Glue | 20 |
| Machine, Hot Glue | 20 |
| Machinery joining | 61-64 |
| Machinery, air compressor | 60 |
| Machinery, dust collector | 60 |
| Machinery, Fletcher Mattcutters | 67 |
| Machinery, Keencut | 65-66 |
| Machinery, saws and cutting | 54-59 |
| Machinery, Zund | 744 |
| Maestri Staple Gun | 31 |
| Magnet Tape | 19 |
| Mat board box for packaging | 12 |
| Mat Board Colourmount | 40-43 |
| Mat Board Designer | 47 |
| Mat Board Duo | 37 |

| ORDER CODE | PG |
|------------------------------------|-------|
| Mat Board Genesis | 47 |
| Mat Board Rising | 38-39 |
| Mat Board Rising, Conservation | 39 |
| Mat Board Specialty Essential | 44-46 |
| Mat Board Storage cart | 12 |
| Mat Board Suede | 49 |
| Mat cutter blades, Zund | 27 |
| Mat cutting blades, Fletcher | 26 |
| Mat cutting blades, Keencut | 26 |
| Matboard, Designer | 49 |
| Matboard, Rising | 38-39 |
| Matboard, Specialty | 48-49 |
| Matisse colour acrylic | 21 |
| Matt Cutters, Fletcher | 67 |
| Matt Cutters, Keencut | 65 |
| Measuring Tape | 28 |
| Mending Plates | 5 |
| Mirror Chain | 3 |
| Mirror Glass | 36 |
| Mirror Hook and clip | 9 |
| Mohawk canas finish aerosol | 22 |
| Morso Guillotine Blades | 28 |
| Moulded Sports Acrylic | 9 |
| Mounting Tissue | 53 |
| Mounting, prints | 10 |
| Multimaster Gun, Fletcher (Yellow) | 29 |
| Multi Master Points, Fletcher | 30 |
| Oil for Air Tools | 31 |
| Omer Flexigun | 29 |
| P90 plus hinging tape | 16 |
| Packing Tape | 11 |
| Pad, Cleaning | 13 |
| Pallet Wrap | 12 |
| Paper Corners | 12 |
| Permanent Markers, Sakura | 22 |
| Perspex Boxes | 9 |
| Picture Plate | 7 |
| Picture Rail Hooks | 7 |
| Picture Wall Hooks Brass | 9 |
| Pin Gun & pins | 31 |
| Pins Stainless steel | 11 |
| Plastic Bundler | 12 |
| Plastic Cleaners | 13 |
| Plastic Scratch Remover | 13 |

| ORDER CODE | PG |
|-------------------------------|-------|
| Plastic Wrap | 12 |
| Pliers Crimp | 4 |
| Pliers, Canvas | 26 |
| Pliers, Diagonal | 25 |
| Pliers, Glass | 25 |
| Preservation Clear Glass | 34 |
| Puncher, hand-held | 7 |
| Putty | 22 |
| Pva Black Magic | 20 |
| PVA Glue | 20 |
| Rabbit Space, Frametek | 21 |
| Rapid Staple Gun | 31 |
| Rapid Staples | 33 |
| Release Board, Silicone | 53 |
| Release film | 53 |
| Rigid Points, Framers corner | 30 |
| Rigid Points, Logan | 29 |
| Ring Hanger (one piece) | 7 |
| Rising Matboard | 36-37 |
| Roller | 20 |
| Rolltaq | 19 |
| Rub Gum Pad | 13 |
| Rub 'N' Buff | 22 |
| Rubber Roller | 20 |
| Rulers | 29 |
| Safety Straight Edge, Keencut | 29 |
| Sakura Permanent Markers | 22 |
| Sample board carpet | 10 |
| Saw Blades | 27 |
| Saw Blades, Brevetti | 27 |
| Sawtooth Hangers | 5 |
| Scapa Tapes | 20 |
| Scissors | 28 |
| Scratch Awl | 7 |
| Screw Eye | 7 |
| Screws, self-tapping | 7 |
| Security Anchor | 6 |
| Security Drill Bit | 6 |
| Security Mount Brackets | 6 |
| Security Plate | 6 |
| Security Plate New | 6 |
| Security Screws | 6 |
| Security Wrench | 6 |
| Self Healing Mat | 29 |
| Silicon Clear | 19 |
| Silicone Release Board | 53 |

| ORDER CODE | PG |
|---------------------------------|----------|
| Sleeves for Vbin | 10 |
| Snap Off Blades | 28 |
| Snappy Hooker | 25 |
| Solo glue riter | 14 |
| Specialty Tapes | 16 |
| SpringLock | 6 |
| Square sawtooth hangers | 7 |
| Standback Clip | 10 |
| Standbacks | 11 |
| Standoffs | 9 |
| Staple Gun, Maestri | 31 |
| Staple Guns, Airco | 31 |
| Staple Guns, Swift | 31 |
| Staples, Airco | 33 |
| Staples, Rapid | 33 |
| Static Brush | 13 |
| Stitchery Tape | 16 |
| Strap Hangers | 4,5 |
| String | 3 |
| Stylus Tapes | 15,16 |
| Swift Staple Guns | 31 |
| Swiss Clips | 10 |
| Synthetic Glue | 20 |
| Tab Driver, T225 Framers Corner | 30 |
| Tape Gun/ Dispenser | 15 |
| Tape Measure | 28 |
| Tape, double sided Cloth Tape | 15 |
| Tape, Double-sided | 16,19,20 |
| Tape, Packaging | 11 |
| Tapes, 3M | 19 |
| Tapes, ATG | 19,20 |
| Tapes, Backing | 15 |
| Tapes, Kikusui | 15,16 |
| Tapes, Masking | 15 |
| Tapes, Scapa | 20 |
| Tapes, Specialty | 16,19,20 |
| Tapes, Stylus | 15,16 |
| Tiger Cloth | 13 |
| Touch Up Pens, Chartpak | 22 |
| Touch Up Pens, Sakura | 22 |
| Toyo glass cutters | 24 |
| Trimmer, Hassel Free | 11 |
| Tru vue Glass cleaner | 14 |
| Turn Buttons | 5 |

| ORDER CODE | PG |
|-----------------------------|-------|
| Twirler | 7 |
| Tyvek | 12 |
| Ultimat Futura, Keencut | 66 |
| Ultimat Gold, Keencut | 66 |
| Underpinner | 64 |
| Utility Knife | 28 |
| Vacuum Press | 81 |
| Varnish | 14 |
| Vbins | 10 |
| Velcro | 11 |
| Vnail Top Loader Cartridges | 31 |
| Vnails for MG/Alpha | 32 |
| Vnails Universal | 32 |
| Vnails, Cassese | 32 |
| Vnails, Genesis | 32 |
| Wall Cutter, Keencut | 65 |
| Wax stick | 27 |
| Wire | 3 |
| Wire, Caddy | 4 |
| Wire, Crimp | 4 |
| Wire, Suflon | 4 |
| Wizard Blades | 27 |
| Wizard CMC | 70-73 |
| Wood Hangers | 4 |
| Workstation | 80 |
| Wypall | 13 |
| Zenith Foamboard | 52 |
| Zund Mat cutter blades | 74 |
| Zund, matcutter | 74 |

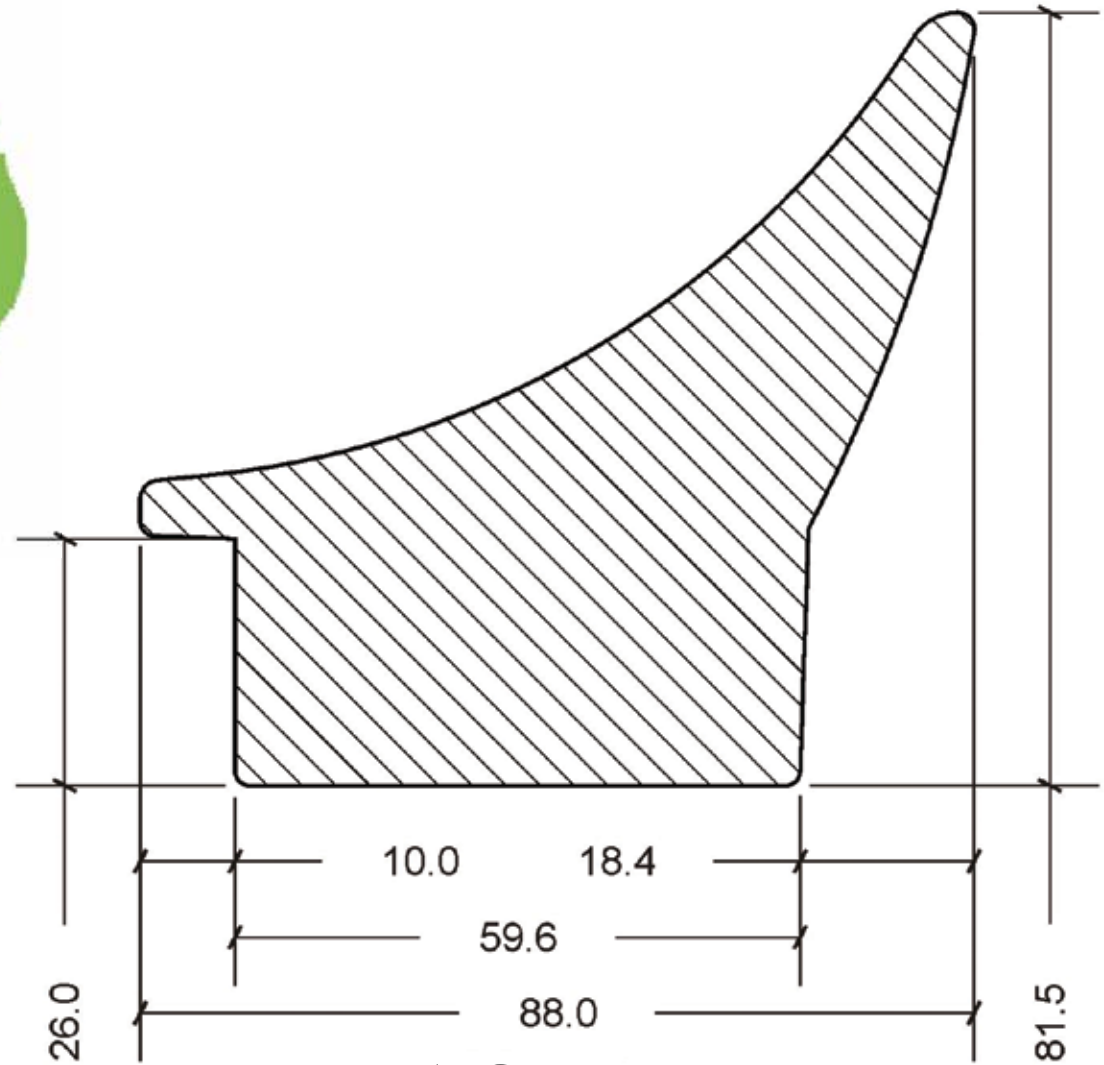

ACM 700

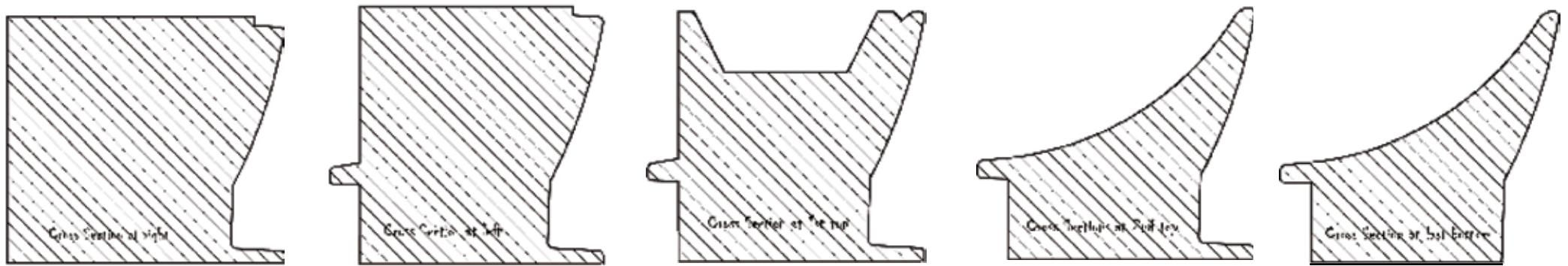

The Creation of a New Moulding

Knife Trimmings at the moulding machine

All care has been taken with the products in this catalogue, but due to the print process, colours may vary. Where colour is critical please request sample.

PCA Moulding Per Metre & Chop Price List

| CODE | PRICE | 15M PRICE | BOX PRICE (See catalogue for quantities) | CHOP PRICE |
|-------|----------|-----------|---|------------|
| PCA1 | \$ 1.80 | \$ 1.62 | \$ 1.53 | \$ 3.60 |
| PCA2 | \$ 2.10 | \$ 1.89 | \$ 1.79 | \$ 4.20 |
| PCA3 | \$ 2.20 | \$ 1.98 | \$ 1.87 | \$ 4.40 |
| PCA4 | \$ 2.45 | \$ 2.21 | \$ 2.08 | \$ 4.90 |
| PCA5 | \$ 2.75 | \$ 2.48 | \$ 2.34 | \$ 5.50 |
| PCA6 | \$ 3.05 | \$ 2.75 | \$ 2.59 | \$ 6.10 |
| PCA7 | \$ 3.30 | \$ 2.97 | \$ 2.81 | \$ 6.60 |
| PCA8 | \$ 3.60 | \$ 3.24 | \$ 3.06 | \$ 7.20 |
| PCA9 | \$ 3.95 | \$ 3.56 | \$ 3.36 | \$ 7.90 |
| PCA10 | \$ 4.25 | \$ 3.83 | \$ 3.61 | \$ 8.50 |
| PCA11 | \$ 4.55 | \$ 4.10 | \$ 3.87 | \$ 9.10 |
| PCA12 | \$ 4.65 | \$ 4.19 | \$ 3.95 | \$ 9.30 |
| PCA13 | \$ 4.85 | \$ 4.37 | \$ 4.12 | \$ 9.70 |
| PCA14 | \$ 5.40 | \$ 4.86 | \$ 4.59 | \$ 10.80 |
| PCA15 | \$ 5.75 | \$ 5.18 | \$ 4.89 | \$ 11.50 |
| PCA16 | \$ 5.85 | \$ 5.27 | \$ 4.97 | \$ 11.70 |
| PCA17 | \$ 5.95 | \$ 5.36 | \$ 5.06 | \$ 11.90 |
| PCA18 | \$ 6.35 | \$ 5.72 | \$ 5.40 | \$ 12.70 |
| PCA19 | \$ 6.50 | \$ 5.85 | \$ 5.53 | \$ 13.00 |
| PCA20 | \$ 6.90 | \$ 6.21 | \$ 5.87 | \$ 13.80 |
| PCA21 | \$ 7.25 | \$ 6.53 | \$ 6.16 | \$ 14.50 |
| PCA22 | \$ 7.40 | \$ 6.66 | \$ 6.29 | \$ 14.80 |
| PCA23 | \$ 7.70 | \$ 6.93 | \$ 6.55 | \$ 15.40 |
| PCA24 | \$ 7.95 | \$ 7.16 | \$ 6.76 | \$ 15.90 |
| PCA25 | \$ 8.00 | \$ 7.20 | \$ 6.80 | \$ 16.00 |
| PCA26 | \$ 8.10 | \$ 7.29 | \$ 6.89 | \$ 16.20 |
| PCA27 | \$ 8.20 | \$ 7.38 | \$ 6.97 | \$ 16.40 |
| PCA28 | \$ 8.50 | \$ 7.65 | \$ 7.23 | \$ 17.00 |
| PCA29 | \$ 8.80 | \$ 7.92 | \$ 7.48 | \$ 17.60 |
| PCA30 | \$ 9.05 | \$ 8.15 | \$ 7.69 | \$ 18.10 |
| PCA31 | \$ 9.25 | \$ 8.33 | \$ 7.86 | \$ 18.50 |
| PCA32 | \$ 9.35 | \$ 8.42 | \$ 7.95 | \$ 18.70 |
| PCA33 | \$ 9.65 | \$ 8.69 | \$ 8.20 | \$ 19.30 |
| PCA34 | \$ 9.75 | \$ 8.78 | \$ 8.29 | \$ 19.50 |
| PCA35 | \$ 9.85 | \$ 8.87 | \$ 8.37 | \$ 19.70 |
| PCA36 | \$ 10.05 | \$ 9.05 | \$ 8.54 | \$ 20.10 |
| PCA37 | \$ 10.20 | \$ 9.18 | \$ 8.67 | \$ 20.40 |
| PCA38 | \$ 10.55 | \$ 9.50 | \$ 8.97 | \$ 21.10 |
| PCA39 | \$ 10.80 | \$ 9.72 | \$ 9.18 | \$ 21.60 |
| PCA40 | \$ 11.15 | \$ 10.04 | \$ 9.48 | \$ 22.30 |
| PCA41 | \$ 11.40 | \$ 10.26 | \$ 9.69 | \$ 22.80 |
| PCA42 | \$ 11.85 | \$ 10.67 | \$ 10.07 | \$ 23.70 |
| PCA43 | \$ 12.05 | \$ 10.85 | \$ 10.24 | \$ 24.10 |
| PCA44 | \$ 12.45 | \$ 11.21 | \$ 10.58 | \$ 24.90 |
| PCA45 | \$ 12.80 | \$ 11.52 | \$ 10.88 | \$ 25.60 |
| PCA46 | \$ 13.15 | \$ 11.84 | \$ 11.18 | \$ 26.30 |
| PCA47 | \$ 14.00 | \$ 12.60 | \$ 11.90 | \$ 28.00 |
| PCA48 | \$ 14.70 | \$ 13.23 | \$ 12.50 | \$ 29.40 |
| PCA49 | \$ 15.40 | \$ 13.86 | \$ 13.09 | \$ 30.80 |
| PCA50 | \$ 15.55 | \$ 14.00 | \$ 13.22 | \$ 31.10 |
| PCA51 | \$ 17.00 | \$ 15.30 | \$ 14.45 | \$ 34.00 |
| PCA52 | \$ 18.60 | \$ 16.74 | \$ 15.81 | \$ 37.20 |
| PCA53 | \$ 19.35 | \$ 17.42 | \$ 16.45 | \$ 38.70 |
| PCA54 | \$ 20.50 | \$ 18.45 | \$ 17.43 | \$ 41.00 |
| PCA55 | \$ 20.95 | \$ 18.86 | \$ 17.81 | \$ 41.90 |
| PCA56 | \$ 22.45 | \$ 20.21 | \$ 19.08 | \$ 44.90 |
| PCA57 | \$ 26.15 | \$ 23.54 | \$ 22.23 | \$ 52.30 |
| PCA58 | \$ 28.05 | \$ 25.25 | \$ 23.84 | \$ 56.10 |
| PCA59 | \$ 31.05 | \$ 27.95 | \$ 26.39 | \$ 62.10 |
| PCA60 | \$ 35.70 | \$ 32.13 | \$ 30.35 | \$ 71.40 |
| PCA61 | \$ 41.95 | \$ 37.76 | \$ 35.66 | \$ 83.90 |
| PCA62 | \$ 45.55 | \$ 41.00 | \$ 38.72 | \$ 91.10 |
| PCA63 | \$ 48.10 | \$ 43.29 | \$ 40.89 | \$ 96.20 |

PCE Moulding Per Metre & Chop Price List

| CODE | PRICE | 15M PRICE | BOX PRICE (See catalogue for quantities) | CHOP PRICE |
|-------|----------|-----------|---|------------|
| PCU1 | \$ 2.10 | \$ 1.89 | \$ 1.79 | \$ 4.20 |
| PCU2 | \$ 2.40 | \$ 2.16 | \$ 2.04 | \$ 4.80 |
| PCU3 | \$ 2.50 | \$ 2.25 | \$ 2.13 | \$ 5.00 |
| PCU4 | \$ 2.85 | \$ 2.57 | \$ 2.42 | \$ 5.70 |
| PCU5 | \$ 3.15 | \$ 2.84 | \$ 2.68 | \$ 6.30 |
| PCU6 | \$ 3.50 | \$ 3.15 | \$ 2.98 | \$ 7.00 |
| PCU7 | \$ 3.80 | \$ 3.42 | \$ 3.23 | \$ 7.60 |
| PCU8 | \$ 4.15 | \$ 3.74 | \$ 3.53 | \$ 8.30 |
| PCU9 | \$ 4.45 | \$ 4.01 | \$ 3.78 | \$ 8.90 |
| PCU10 | \$ 4.95 | \$ 4.46 | \$ 4.21 | \$ 9.90 |
| PCU11 | \$ 5.25 | \$ 4.73 | \$ 4.46 | \$ 10.50 |
| PCU12 | \$ 5.35 | \$ 4.82 | \$ 4.55 | \$ 10.70 |
| PCU13 | \$ 5.60 | \$ 5.04 | \$ 4.76 | \$ 11.20 |
| PCU14 | \$ 6.20 | \$ 5.58 | \$ 5.27 | \$ 12.40 |
| PCU15 | \$ 6.60 | \$ 5.94 | \$ 5.61 | \$ 13.20 |
| PCU16 | \$ 6.65 | \$ 5.99 | \$ 5.65 | \$ 13.30 |
| PCU17 | \$ 6.85 | \$ 6.17 | \$ 5.82 | \$ 13.70 |
| PCU18 | \$ 7.25 | \$ 6.53 | \$ 6.16 | \$ 14.50 |
| PCU19 | \$ 7.45 | \$ 6.71 | \$ 6.33 | \$ 14.90 |
| PCU20 | \$ 7.90 | \$ 7.11 | \$ 6.72 | \$ 15.80 |
| PCU21 | \$ 8.30 | \$ 7.47 | \$ 7.06 | \$ 16.60 |
| PCU22 | \$ 8.50 | \$ 7.65 | \$ 7.23 | \$ 17.00 |
| PCU23 | \$ 8.80 | \$ 7.92 | \$ 7.48 | \$ 17.60 |
| PCU24 | \$ 9.05 | \$ 8.15 | \$ 7.69 | \$ 18.10 |
| PCU25 | \$ 9.20 | \$ 8.28 | \$ 7.82 | \$ 18.40 |
| PCU26 | \$ 9.25 | \$ 8.33 | \$ 7.86 | \$ 18.50 |
| PCU27 | \$ 9.35 | \$ 8.42 | \$ 7.95 | \$ 18.70 |
| PCU28 | \$ 9.70 | \$ 8.73 | \$ 8.25 | \$ 19.40 |
| PCU29 | \$ 10.10 | \$ 9.09 | \$ 8.59 | \$ 20.20 |
| PCU30 | \$ 10.40 | \$ 9.36 | \$ 8.84 | \$ 20.80 |
| PCU31 | \$ 10.55 | \$ 9.50 | \$ 8.97 | \$ 21.10 |
| PCU32 | \$ 11.05 | \$ 9.95 | \$ 9.39 | \$ 22.10 |
| PCU33 | \$ 11.00 | \$ 9.90 | \$ 9.35 | \$ 22.00 |
| PCU34 | \$ 11.10 | \$ 9.99 | \$ 9.44 | \$ 22.20 |
| PCU35 | \$ 11.25 | \$ 10.13 | \$ 9.56 | \$ 22.50 |
| PCU36 | \$ 11.50 | \$ 10.35 | \$ 9.78 | \$ 23.00 |
| PCU37 | \$ 11.75 | \$ 10.58 | \$ 9.99 | \$ 23.50 |
| PCU38 | \$ 12.00 | \$ 10.80 | \$ 10.20 | \$ 24.00 |
| PCU39 | \$ 12.40 | \$ 11.16 | \$ 10.54 | \$ 24.80 |
| PCU40 | \$ 12.75 | \$ 11.48 | \$ 10.84 | \$ 25.50 |
| PCU41 | \$ 13.05 | \$ 11.75 | \$ 11.09 | \$ 26.10 |
| PCU42 | \$ 13.50 | \$ 12.15 | \$ 11.48 | \$ 27.00 |
| PCU43 | \$ 13.80 | \$ 12.42 | \$ 11.73 | \$ 27.60 |
| PCU44 | \$ 14.10 | \$ 12.69 | \$ 11.99 | \$ 28.20 |
| PCU45 | \$ 14.70 | \$ 13.23 | \$ 12.50 | \$ 29.40 |
| PCU46 | \$ 15.05 | \$ 13.55 | \$ 12.79 | \$ 30.10 |
| PCU47 | \$ 16.05 | \$ 14.45 | \$ 13.64 | \$ 32.10 |
| PCU48 | \$ 16.80 | \$ 15.12 | \$ 14.28 | \$ 33.60 |
| PCU49 | \$ 17.65 | \$ 15.89 | \$ 15.00 | \$ 35.30 |
| PCU50 | \$ 17.75 | \$ 15.98 | \$ 15.09 | \$ 35.50 |
| PCU51 | \$ 19.45 | \$ 17.51 | \$ 16.53 | \$ 38.90 |
| PCU52 | \$ 21.30 | \$ 19.17 | \$ 18.11 | \$ 42.60 |
| PCU53 | \$ 22.15 | \$ 19.94 | \$ 18.83 | \$ 44.30 |
| PCU54 | \$ 23.45 | \$ 21.11 | \$ 19.93 | \$ 46.90 |
| PCU55 | \$ 23.95 | \$ 21.56 | \$ 20.36 | \$ 47.90 |
| PCU56 | \$ 25.70 | \$ 23.13 | \$ 21.85 | \$ 51.40 |
| PCU57 | \$ 29.90 | \$ 26.91 | \$ 25.42 | \$ 59.80 |
| PCU58 | \$ 31.95 | \$ 28.76 | \$ 27.16 | \$ 63.90 |
| PCU59 | \$ 35.50 | \$ 31.95 | \$ 30.18 | \$ 71.00 |
| PCU60 | \$ 40.80 | \$ 36.72 | \$ 34.68 | \$ 81.60 |
| PCU61 | \$ 47.95 | \$ 43.16 | \$ 40.76 | \$ 95.90 |
| PCU62 | \$ 53.20 | \$ 47.88 | \$ 45.22 | \$ 106.40 |
| PCU63 | \$ 55.05 | \$ 49.55 | \$ 46.79 | \$ 110.10 |

PCU Moulding Per Metre & Chop Price List

| CODE | PRICE | 15M PRICE | BOX PRICE (See catalogue for quantities) | CHOP PRICE |
|-------|----------|-----------|---|------------|
| PCU1 | \$ 2.10 | \$ 1.89 | \$ 1.79 | \$ 4.20 |
| PCU2 | \$ 2.40 | \$ 2.16 | \$ 2.04 | \$ 4.80 |
| PCU3 | \$ 2.50 | \$ 2.25 | \$ 2.13 | \$ 5.00 |
| PCU4 | \$ 2.85 | \$ 2.57 | \$ 2.42 | \$ 5.70 |
| PCU5 | \$ 3.15 | \$ 2.84 | \$ 2.68 | \$ 6.30 |
| PCU6 | \$ 3.50 | \$ 3.15 | \$ 2.98 | \$ 7.00 |
| PCU7 | \$ 3.80 | \$ 3.42 | \$ 3.23 | \$ 7.60 |
| PCU8 | \$ 4.15 | \$ 3.74 | \$ 3.53 | \$ 8.30 |
| PCU9 | \$ 4.45 | \$ 4.01 | \$ 3.78 | \$ 8.90 |
| PCU10 | \$ 4.95 | \$ 4.46 | \$ 4.21 | \$ 9.90 |
| PCU11 | \$ 5.25 | \$ 4.73 | \$ 4.46 | \$ 10.50 |
| PCU12 | \$ 5.35 | \$ 4.82 | \$ 4.55 | \$ 10.70 |
| PCU13 | \$ 5.60 | \$ 5.04 | \$ 4.76 | \$ 11.20 |
| PCU14 | \$ 6.20 | \$ 5.58 | \$ 5.27 | \$ 12.40 |
| PCU15 | \$ 6.60 | \$ 5.94 | \$ 5.61 | \$ 13.20 |
| PCU16 | \$ 6.65 | \$ 5.99 | \$ 5.65 | \$ 13.30 |
| PCU17 | \$ 6.85 | \$ 6.17 | \$ 5.82 | \$ 13.70 |
| PCU18 | \$ 7.25 | \$ 6.53 | \$ 6.16 | \$ 14.50 |
| PCU19 | \$ 7.45 | \$ 6.71 | \$ 6.33 | \$ 14.90 |
| PCU20 | \$ 7.90 | \$ 7.11 | \$ 6.72 | \$ 15.80 |
| PCU21 | \$ 8.30 | \$ 7.47 | \$ 7.06 | \$ 16.60 |
| PCU22 | \$ 8.50 | \$ 7.65 | \$ 7.23 | \$ 17.00 |
| PCU23 | \$ 8.80 | \$ 7.92 | \$ 7.48 | \$ 17.60 |
| PCU24 | \$ 9.05 | \$ 8.15 | \$ 7.69 | \$ 18.10 |
| PCU25 | \$ 9.20 | \$ 8.28 | \$ 7.82 | \$ 18.40 |
| PCU26 | \$ 9.25 | \$ 8.33 | \$ 7.86 | \$ 18.50 |
| PCU27 | \$ 9.35 | \$ 8.42 | \$ 7.95 | \$ 18.70 |
| PCU28 | \$ 9.70 | \$ 8.73 | \$ 8.25 | \$ 19.40 |
| PCU29 | \$ 10.10 | \$ 9.09 | \$ 8.59 | \$ 20.20 |
| PCU30 | \$ 10.40 | \$ 9.36 | \$ 8.84 | \$ 20.80 |
| PCU31 | \$ 10.55 | \$ 9.50 | \$ 8.97 | \$ 21.10 |
| PCU32 | \$ 11.05 | \$ 9.95 | \$ 9.39 | \$ 22.10 |
| PCU33 | \$ 11.00 | \$ 9.90 | \$ 9.35 | \$ 22.00 |
| PCU34 | \$ 11.10 | \$ 9.99 | \$ 9.44 | \$ 22.20 |
| PCU35 | \$ 11.25 | \$ 10.13 | \$ 9.56 | \$ 22.50 |
| PCU36 | \$ 11.50 | \$ 10.35 | \$ 9.78 | \$ 23.00 |
| PCU37 | \$ 11.75 | \$ 10.58 | \$ 9.99 | \$ 23.50 |
| PCU38 | \$ 12.00 | \$ 10.80 | \$ 10.20 | \$ 24.00 |
| PCU39 | \$ 12.40 | \$ 11.16 | \$ 10.54 | \$ 24.80 |
| PCU40 | \$ 12.75 | \$ 11.48 | \$ 10.84 | \$ 25.50 |
| PCU41 | \$ 13.05 | \$ 11.75 | \$ 11.09 | \$ 26.10 |
| PCU42 | \$ 13.50 | \$ 12.15 | \$ 11.48 | \$ 27.00 |
| PCU43 | \$ 13.80 | \$ 12.42 | \$ 11.73 | \$ 27.60 |
| PCU44 | \$ 14.10 | \$ 12.69 | \$ 11.99 | \$ 28.20 |
| PCU45 | \$ 14.70 | \$ 13.23 | \$ 12.50 | \$ 29.40 |
| PCU46 | \$ 15.05 | \$ 13.55 | \$ 12.79 | \$ 30.10 |
| PCU47 | \$ 16.05 | \$ 14.45 | \$ 13.64 | \$ 32.10 |
| PCU48 | \$ 16.80 | \$ 15.12 | \$ 14.28 | \$ 33.60 |
| PCU49 | \$ 17.65 | \$ 15.89 | \$ 15.00 | \$ 35.30 |
| PCU50 | \$ 17.75 | \$ 15.98 | \$ 15.09 | \$ 35.50 |
| PCU51 | \$ 19.45 | \$ 17.51 | \$ 16.53 | \$ 38.90 |
| PCU52 | \$ 21.30 | \$ 19.17 | \$ 18.11 | \$ 42.60 |
| PCU53 | \$ 22.15 | \$ 19.94 | \$ 18.83 | \$ 44.30 |
| PCU54 | \$ 23.45 | \$ 21.11 | \$ 19.93 | \$ 46.90 |
| PCU55 | \$ 23.95 | \$ 21.56 | \$ 20.36 | \$ 47.90 |
| PCU56 | \$ 25.70 | \$ 23.13 | \$ 21.85 | \$ 51.40 |
| PCU57 | \$ 29.90 | \$ 26.91 | \$ 25.42 | \$ 59.80 |
| PCU58 | \$ 31.95 | \$ 28.76 | \$ 27.16 | \$ 63.90 |
| PCU59 | \$ 35.50 | \$ 31.95 | \$ 30.18 | \$ 71.00 |
| PCU60 | \$ 40.80 | \$ 36.72 | \$ 34.68 | \$ 81.60 |
| PCU61 | \$ 47.95 | \$ 43.16 | \$ 40.76 | \$ 95.90 |
| PCU62 | \$ 53.20 | \$ 47.88 | \$ 45.22 | \$ 106.40 |
| PCU63 | \$ 55.05 | \$ 49.55 | \$ 46.79 | \$ 110.10 |

ACM Moulding Per Metre & Chop Price List

| CODE | PRICE LIST | 15MT PRICE | 18MT PRICE | BOX PRICE | CHOP PRICE |
|-------|------------|------------|------------|-----------|------------|
| ACM A | \$ 7.10 | \$ 6.75 | \$ 6.39 | \$ 6.04 | \$ 14.20 |
| ACM B | \$ 8.00 | \$ 7.60 | \$ 7.20 | \$ 6.80 | \$ 16.00 |
| ACM C | \$ 8.50 | \$ 8.08 | \$ 7.65 | \$ 7.23 | \$ 17.00 |
| ACM D | \$ 10.25 | \$ 9.74 | \$ 9.23 | \$ 8.71 | \$ 20.50 |
| ACM E | \$ 10.50 | \$ 9.98 | \$ 9.45 | \$ 8.93 | \$ 21.00 |
| ACM F | \$ 10.70 | \$ 10.17 | \$ 9.63 | \$ 9.10 | \$ 21.40 |
| ACM G | \$ 11.30 | \$ 10.74 | \$ 10.17 | \$ 9.61 | \$ 22.60 |
| ACM H | \$ 12.40 | \$ 11.78 | \$ 11.16 | \$ 10.54 | \$ 24.80 |
| ACM I | \$ 13.10 | \$ 12.45 | \$ 11.79 | \$ 11.14 | \$ 26.20 |
| ACM J | \$ 13.55 | \$ 12.87 | \$ 12.20 | \$ 11.52 | \$ 27.10 |
| ACM K | \$ 16.15 | \$ 15.34 | \$ 14.54 | \$ 13.73 | \$ 32.30 |
| ACM L | \$ 16.55 | \$ 15.72 | \$ 14.90 | \$ 14.07 | \$ 33.10 |
| ACM M | \$ 17.40 | \$ 16.53 | \$ 15.66 | \$ 14.79 | \$ 34.80 |
| ACM N | \$ 17.75 | \$ 16.86 | \$ 15.98 | \$ 15.09 | \$ 35.50 |
| ACM O | \$ 18.80 | \$ 17.86 | \$ 16.92 | \$ 15.98 | \$ 37.60 |
| ACM P | \$ 22.70 | \$ 21.57 | \$ 20.43 | \$ 19.30 | \$ 45.40 |
| ACM Q | \$ 24.50 | \$ 23.28 | \$ 22.05 | \$ 20.83 | \$ 49.00 |
| ACM R | \$ 28.50 | \$ 27.08 | \$ 25.65 | \$ 24.23 | \$ 57.00 |
| ACM S | | | | | |

Terms and Conditions

TERMS AND CONDITIONS OF SALE

Applicable to and forming part of any contract for goods manufactured, sold or supplied or for work and labour done by Chamton Pty Ltd (hereunder called "Chamton") for the Customer named on the face hereof (hereunder called "the Customer") and applicable to the whole or any executed part of an order.

1. PRICE

Unless otherwise specified in writing by Chamton to the Customer;

- Prices in respect of an order are those prices current at the date of delivery
- All prices are subject to change within notice.

2. PAYMENT

Unless otherwise specified in writing by Chamton to the Customer;

- Payment for any goods manufactured, sold or supplied (hereinafter called "the Goods") or for work and labour done by Chamton to or for the Customer shall be Made within thirty (30) days after the delivery of the invoice to the Customer.
- Interest shall accrue and be payable on all overdue accounts at the rate equal to Two and half percent (2.5%) above the rate fixed under section 2 of the Penalty Interest Rates Act 1983 at the time default.
- Chamton reserves the right to withhold delivery of the Goods if the Customer is in Any way in breach of these Terms and Conditions of Sale.

3. ACCEPTANCE

Chamton reserves the right to delivery by instalments and each instalment shall be deemed to be sold under separate contract. Failure to deliver any instalments shall not entitle the Customer to repudiate the contract. Rejection of any instalment does not authorize rejection of any other instalment. Each instalment constitutes a separate contract without prejudice to the main contract.

The provision of Division 3 of the Goods Act 1958 (as amended) shall apply to this contract while not inconsistent herewith. In the event of any such inconsistency the terms of this contract shall prevail.

4. QUANTITY

The quantity of Goods ordered by the Customer will be supplied as near as

Practicable by Chamton and Chamton shall deliver and the Customer shall accept the Actual quantity of Goods delivered against this contract up to a margin of 10 percent More or less or to the nearest pack lot whichever is the larger.

5. LIMITATION OF LIABILITY

If for any cause or reason beyond the control of Chamton (including but not limited to fire, flood, earthquake, other natural disasters or Act of God, war, hostilities or threat of war or hostilities, strikes, lockouts, industrial disputes, Governmental control whether by intervention, legislation or regulation or by Government authority or any restriction of prohibition or contingencies hindering or preventing delivery) Chamton is delayed or impeded in fulfilling its obligation under this contract, then Chamton, upon notifying the Customer, may suspend further performance of the contract until performance of Chamton's obligations under the contract can be recommended, or if Chamton is so delayed or impeded or is frustrated or prevented from completing the contract for a continuous period of two (2) months the contract may be terminated by Chamton, and the contract shall become voidable at Chamton's option, and the Customer shall in the instance of Goods manufactured or supplied to meet the Customer's particular requirements and, notwithstanding such termination and/or rendering void the order, pay for any instalments and individual items if wholly manufactured at the price for same pursuant to this contract or if partially manufactured at a pro-rata adjustment of the price.

Without limiting the foregoing delivery dates quoted on behalf of Chamton are estimates and approximate only although Chamton will use reasonable endeavours to maintain these estimates. Goods the subject of this contract shall be in all respects at the Customer's risk upon delivery being made and if the Goods are delivered by instalments, those Goods delivered by instalments shall be at the Customer's risk upon delivery of the instalment being made. Goods the subject of this contract shall be at the Customer's risk upon such delivery being made whether payment has been made or not made for those Goods or instalments thereof.

This contract contains all the Terms and Conditions under which the Goods are to be sold and any express or implied conditions, statement, representation or warranty, statutory or otherwise not stated herein is hereby excluded. No variation of these Terms and Conditions of Sale or representations bearing thereon will be binding on Chamton unless confirmed in writing by Chamton. Any warranties or Conditions statutory or otherwise as to quality or fitness for any purpose are excluded and the Customer relies on his own judgment. No Goods may be returned to Chamton without the prior written approval of Chamton being first obtained. If such approval is obtained the Goods concerned shall be returned to Chamton properly packaged so as to prevent damage in transit and within fourteen (14) days from the date of delivery. Chamton shall not otherwise be subject to nor incur and the Customer releases Chamton from any claim, action or liability including any expenditure, consequential loss or damage, loss of use or profits resulting from or by reason of any suspension or avoidance under this clause or faulty or defective original or replacement Goods, materials or workmanship, negligence or any act matter or thing done, permitted or omitted by Chamton. Any Goods approved for return to Chamton as aforesaid shall be the property of Chamton to dispose of as it sees fit.

6. CANCELLATION

In event of the Customer's death, insolvency, bankruptcy or winding up, suspension of payments, dissolution, or modification of proprietors or partnership, non payment for or non payment acceptance of any delivery, Chamton may cancel this contract or suspend or continue deliveries always reserving all rights to recover from the Customer any loss occasioned thereby. Cancellation of orders on whole or in part cannot be accepted without Chamton's consent in writing and then only on terms that the Customer will compensate Chamton for all work done and materials used to the date of cancellation and the loss of profit suffered by Chamton as a result thereof.

7. ASSIGNMENT AND FACTORING OF BOOK DEBITS

The Customer shall not assign, factor, transfer, enter into any forward sale agreement or otherwise dispose of its book debts to a third party without first obtaining the written consent of Chamton, which consent shall not be withheld unreasonably.

8. RETENTION OF TITLE, LIEN, PLEDGE AND TRUSTS

- It is expressly agreed and acknowledged by the Customer that the legal and equitable title to the Goods supplied by Chamton as described in Chamton's invoice shall not pass to the Customer unless and until all monies owed or proceeds received in respect to the Goods are paid to Chamton for the full amount of the Invoice (including any interest payable in accordance with Clause 2(b) hereof). In the interim, Chamton shall retain the legal and equitable title to the Goods, and the Customer shall take custody of and hold the Goods as the fiduciary agent and bailee of Chamton.
- The Customer may resell the Goods to the third parties in the normal course of trading, but only as a fiduciary agent of Chamton. Any such re-sale is to be a arms length and any right to bind Chamton to any liability to any third party by contract or otherwise is expressly negative.
- The Customer shall keep the goods separate from its own, property stored and identified, protected and insured.
- All monies and proceeds received, whether tangible, direct or indirect of any dealing with such Goods by the Customer for any re-sale, pending re-sale or utilization in any manufacturing or construction process, shall be held by the Customer in trust for Chamton, and paid into a separate bank account ("the Trust Account") with properly maintained records for the benefits and on behalf of Chamton for payment to Chamton in reduction of any monies owed by the Customer to Chamton until the liability to Chamton is fully discharged.
- The customer hereby appoints Chamton to be its lawful attorney and authorizes Chamton to appropriate any payments from the Trust Account to such Goods and accounts as it thinks fit, notwithstanding any directions from or appropriation by the Customer to the contrary.
- If the Customer becomes insolvent, commits any act of insolvency or bankruptcy, or defaults in any payment due by it to Chamton, Chamton shall have the unconditional right, without notice, to retake possession of the Goods and to enter upon the Customer's premises to retake possession of the Goods.
- Without prejudice to the right of Chamton at common law, any undelivered goods which are ascertainable as Goods and having been utilizes in any manufacturing or construction process and remaining upon the premises of the Customer, shall be subject to the retention of title clauses hereof, and be held in trust by the Customer as an agent and fiduciary of Chamton. Such Goods shall further be subject to a special and general lien and pledge for monies owing and due to Chamton for any indebtedness to Chamton from whatever cause by the Customer. If such indebtedness is not paid or otherwise discharged in full by the customer to Chamton within 14 days of receipt of notice from Chamton that it intends to dispose of the Goods, Chamton may, in its absolute discretion, take possession of the Goods and sell the Goods by public auction or private treat, and apply the net proceeds of sale towards reduction of the Customer's indebtedness.
- In the event that the customer uses, mixes or transforms the Goods in some manufacturing or construction process of its own or some third party, then the Customer shall:
 - Hold such part(s) of the proceeds of the manufacturing process as relate(s) to the Goods in trust and in a separate bank account for the benefit and behalf of the Chamton; and
 - Acknowledge that such part(s) of the proceeds to be held in trust for and on behalf of Chamton shall be deemed to equal in dollar terms the amount the amount owing by the Customer to Chamton at the time of receipt of such proceeds.
- For the purposes of the Clause & the term "proceeds" shall mean any proceeds or monies received by the Customer
 - For undelivered goods produced by the Customer manufacturing or construction process, and
 - Arising from the sale and delivery to a third party by the Customer of goods produced from the Customer's manufacturing or construction process, including (but not limited to) monies or payments howsoever received by the Customer from any sale of sales, which for the purposes of this sub-clause, are deemed to be held in trust for the benefit for and on behalf of Chamton in satisfaction and for the discharge of the Customer's indebtedness to Chamton.
- The Customer and Chamton acknowledge that some of the provisions of this Clause 8 are intended to constitute a trust between the parties whereby there is an obligation upon the Customer to create a trust of proceeds. Nothing herein contained shall be construed or deemed to create a legal or equitable charge on the goods, whether or not used, mixed, transformed or produced by the Customer in a manufacturing or construction process. Nor will the proceeds of sale of the Goods from a third party be construed or deemed to create a charge on a book debt.

9. CLAIMS

All claims under this contract must be made in writing and delivered to the registered office of Chamton and marked to the attention of the Manager of the Chamton within seven days from the date of delivery.

10. GENERAL

The Customer, when placing an order with Chamton (whether the order shall be verbal or written), shall be deemed to have accepted these Terms and Conditions of Sale (whether these Terms and Conditions of Sale appear on the back of an invoice or delivery docket or are otherwise brought to the notice of the customer) and if these Terms and Conditions of Sale (which shall only be varied or rescinded by written agreement executed by Chamton) shall differ in any respect from the Customer's order, then these Terms and Conditions of Sale shall prevail. This contract shall in all respects be construed as a contract according to the laws of the capital State of Victoria.



FOR ORDERS
Available 24/7

www.apm-mouldings.com.au



FOR ORDERS Available 24/7

www.apm-mouldings.com.au

APM Mouldings Pty Ltd
120-130 Bolinda Road
Campbellfield, Vic 3061
Australia

Ph +61 3 8301 9199
Ph +61 3 9357 4111
Fax +61 3 9357 4077
Standard call number
1300 733 018
From 7am to 4:20pm

Distributed in
VIC,NSW,QLD,NT,SA
Skype:

Harry.Papadatos
apmvicky
apm.orders
apmchristina

Internet
www.apm-mouldings.com.au

Email
harryp@apm-mouldings.com.au
christinap@apm-mouldings.com.au



New South Wales/ACT Rep:
Steve Rivers
Ph: 0409 868 934
Email: steve@apm-mouldings.com.au

Victoria Rep:
Abby Deniz
Ph: 0448 810 720
Email: abby@apm-mouldings.com.au

Queensland Rep:
Cheryl Wallace
Ph: 0424 728 716
Email: cheryl@apm-mouldings.com.au

Distributed in Western Australia by:
Moulding Distributors
Cliff and Jennifer Gates
Unit 1, 54 Collingwood St
Osborne Park, WA 6017
Ph: 08 9244 4416
Fax: 08 9244 4417
Email: cliff@mouldingdistributors.com.au

Distributed in Tasmania by:
Quadro Nostro Pty Ltd
Tom Miller
27 Patrick Street
Hobart 7000
Ph: 03 6231 3535
Fax: 03 6234 6889
Email: admin@quadronostro.com.au

